

Product data sheet

Subminiature connectors

Product description	Snap-In IP40 Male panel mount connector, Contacts: 4, unshielded, solder, IP40
Area	Snap-In IP40 series 719
Part no.	09 9765 30 04

Illustration



Scale drawing

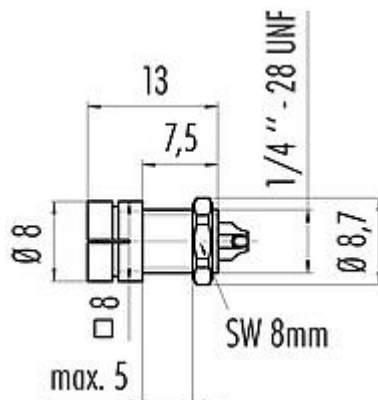

Contact arrangement (Plug-in side)

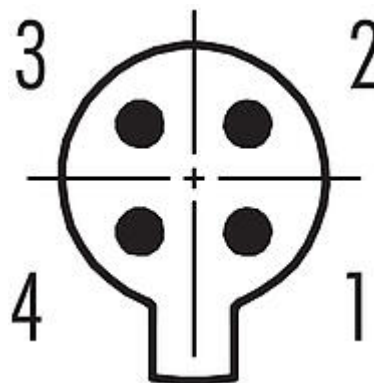

You can find the component part drawing and assembly instructions on the next page.

Technical data

General features

Part no.	09 9765 30 04
Connector design	Male panel mount connector
Version	Connector pin straight
Connector locking system	snap-in
Termination	solder
Degree of protection	IP40
Cross-sectional area	0.25 mm ² / AWG 24
Temperature range from/to	-25 °C / 70 °C
Tightening torque screw nut	0.2 Nm
Mechanical operation	> 100 Mating cycles
Weight (g)	1.23
Customs tariff number	85369010

Electrical parameters

Rated voltage	60 V
Rated impulse voltage	800 V
Rated current (40 °C)	3,0 A
Insulation resistance	≥ 10 ¹⁰ Ω
Pollution degree	1
Overvoltage category	II
Insulating material group	III
EMC compliance	unshielded

Product data sheet

Subminiature connectors

Product description	Snap-In IP40 Male panel mount connector, Contacts: 4, unshielded, solder, IP40
Area	Snap-In IP40 series 719
Part no.	09 9765 30 04

Material

Housing material	PA
Contact body material	PA
Contact material	CuZn (brass)
Contact plating	Au (gold)
REACH SVHC	CAS 7439-92-1 (Lead)
SCIP number	SCIP-number not available

Classifications

eCl@ss 11.1	27-44-01-09
ETIM 7.0	EC003569

Component part drawing

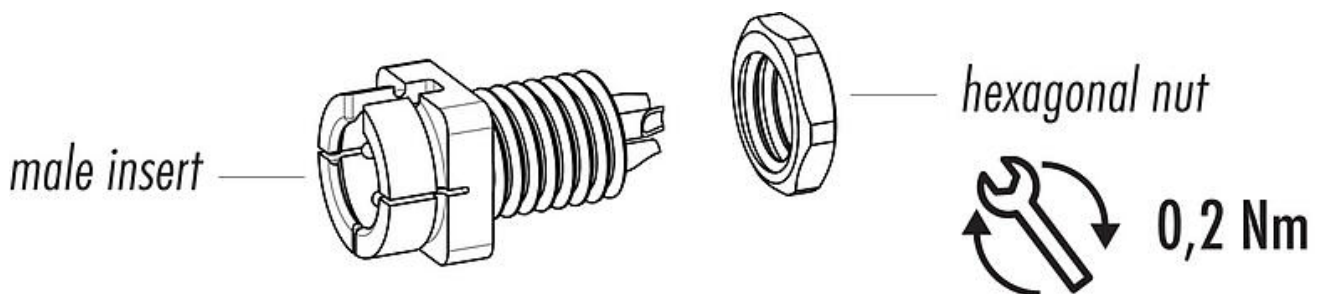

Product description	Snap-In IP40 Male panel mount connector, Contacts: 4, unshielded, solder, IP40
Area	Snap-In IP40 series 719
Part no.	09 9765 30 04

Assembly instructions / Panel cut-out

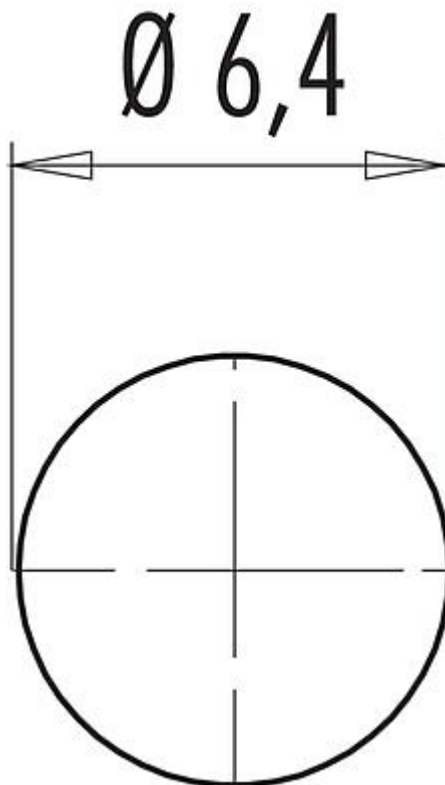

Product data sheet

Subminiature connectors



Product description	Snap-In IP40 Male panel mount connector, Contacts: 4, unshielded, solder, IP40
Area	Snap-In IP40 series 719
Part no.	09 9765 30 04

General Disclaim Notice

The connectors have been developed for applications in plant engineering, control and electrical equipment construction. The user is responsible for checking whether the connectors can also be used in other areas of application.