



40x40x28 mm

San Ace 40 9P_{type}

General Specifications

- Material Frame: Plastic (Flammability: UL 94V-0), Impeller: Plastic (Flammability: UL 94V-1)
- Expected life See the table below. (L10 life: 90% survival rate for continuous operation in free air at 60°C, rated voltage)
Expected life at 40°C is for reference only.
- Motor protection function Locked rotor burnout protection, Reverse polarity protection
For details, please refer to p. 573.
- Dielectric strength 50/60 Hz, 500 VAC, for 1 minute (between lead wire conductors and frame)
- Insulation resistance 10 MΩ or more with a 500 VDC megger (between lead wire conductors and frame)
- Sound pressure level (SPL) At 1 m away from the air inlet
- Storage temperature -30 to +70°C (Non-condensing)
- Lead wire ⊕Red ⊖Black or Blue Sensor Yellow
- Mass 52 g

Specifications

The models listed below **have ribs and pulse sensors.**

Model no.	Rated voltage [V]	Operating voltage range [V]	Rated current [A]	Rated input [W]	Rated speed [min ⁻¹]	Max. airflow [m ³ /min] [CFM]	Max. static pressure [Pa] [inchH ₂ O]	SPL [dB (A)]	Operating temperature [°C]	Expected life [h]
109P0405H3013	5	4.5 to 5.5	0.68	3.4	8700	0.32 11.3	102.9 0.414	37	-20 to +70	40000/60°C (70000/40°C)
109P0405F3013			0.28	1.4	6700	0.244 8.6	58.8 0.236	30		60000/60°C (90000/40°C)
109P0412K3013	12	8 to 13.2	0.55	6.6	15500	0.59 20.8	340 1.365	50	-20 to +60	40000/60°C (70000/40°C)
109P0412J3013		7 to 13.2	0.35	4.2	12500	0.46 16.2	210 0.843	44		
109P0412G3013			0.31	3.72	11500	0.42 14.8	179 0.719	42		
109P0412B3013		7 to 13.8	0.28	3.36	10300	0.38 13.4	143 0.574	40		
109P0412H3013			0.195	2.34	8700	0.32 11.3	102.9 0.414	37	-20 to +70	60000/60°C (90000/40°C)
109P0412F3013		0.105	1.26	6700	0.244 8.6	58.8 0.236	30			
109P0412M3013		10.2 to 13.8	0.045	0.54	4100	0.15 5.3	21.6 0.087	20		
109P0424R3013		24	12 to 26.4	0.25	6	14000	0.51 18.0	263.4 1.057	47	-20 to +60
109P0424J3013	0.18			4.32	12500	0.46 16.2	210 0.843	44		
109P0424G3013	0.19			4.56	11500	0.42 14.8	179 0.719	42		
109P0424B3013	0.13			3.12	10300	0.38 13.4	143 0.574	40		
109P0424H3013	12 to 27.6		0.095	2.28	8700	0.32 11.3	102.9 0.414	37	-20 to +70	60000/60°C (90000/40°C)
109P0424F3013	14 to 27.6		0.055	1.32	6700	0.244 8.6	58.8 0.236	30		

The following sensor and control options are available for selection.

Available for all models. **Without sensor**

Differs according to the model. Refer to the table on pp. 595 to 596. **Lock sensor** **PWM control**

The mark indicates Short LeadTime Service applicable models. See p. 626 for details.

Airflow - Static Pressure Characteristics

109P0405H3013 With pulse sensor

Operating voltage range

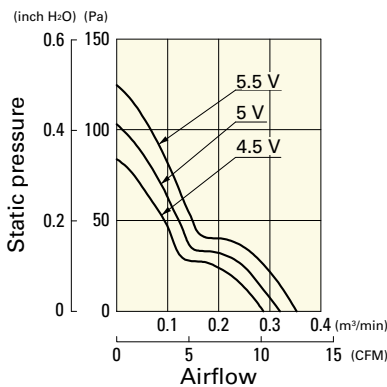

109P0405F3013 With pulse sensor

Operating voltage range

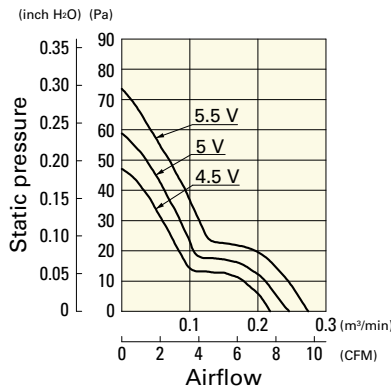

109P0412K3013 With pulse sensor

Operating voltage range

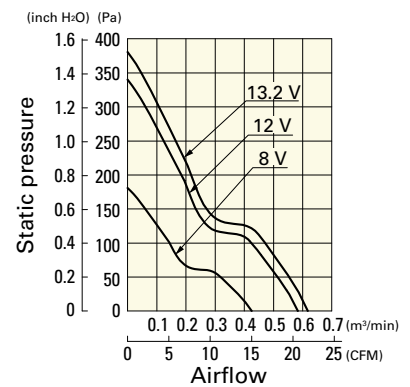

Airflow - Static Pressure Characteristics

109P0412J3013 With pulse sensor

Operating voltage range

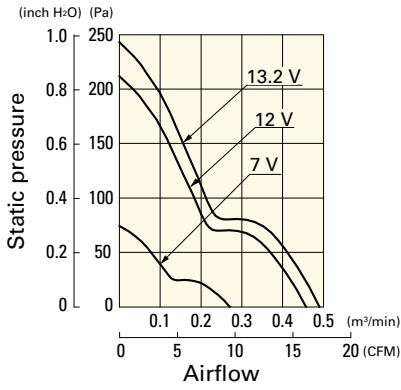

109P0412G3013 With pulse sensor

Operating voltage range

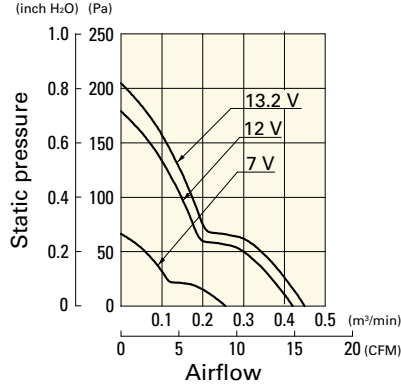

109P0412B3013 With pulse sensor

Operating voltage range

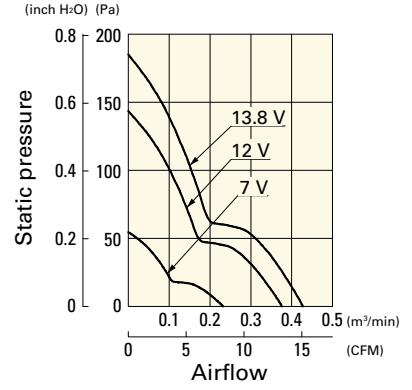

109P0412H3013 With pulse sensor

Operating voltage range

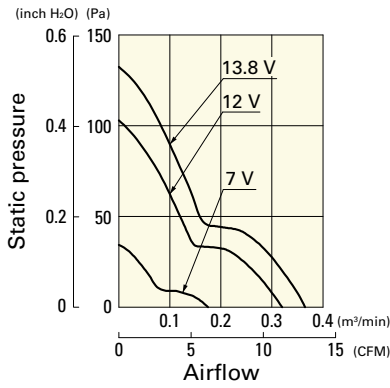

109P0412F3013 With pulse sensor

Operating voltage range

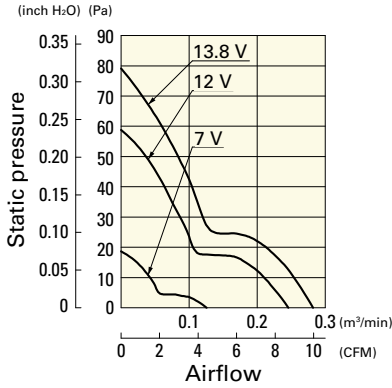

109P0412M3013 With pulse sensor

Operating voltage range

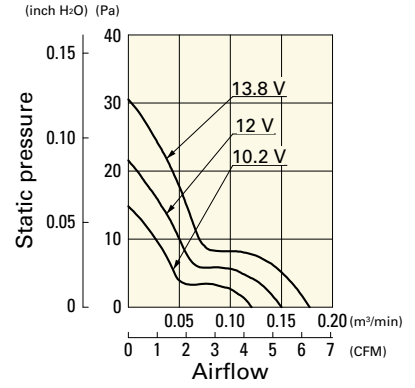

109P0424R3013 With pulse sensor

Operating voltage range

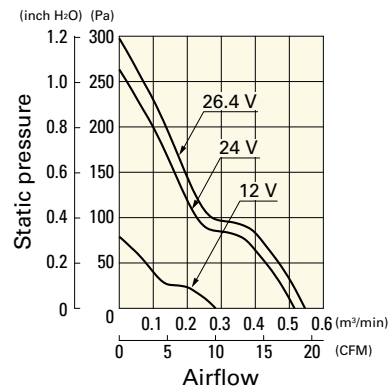

109P0424J3013 With pulse sensor

Operating voltage range

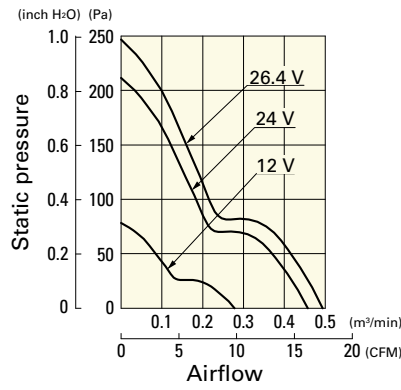

109P0424G3013 With pulse sensor

Operating voltage range

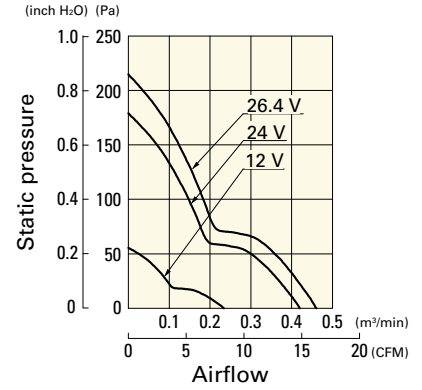

109P0424B3013 With pulse sensor

Operating voltage range

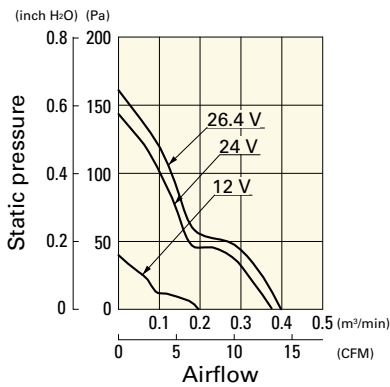

109P0424H3013 With pulse sensor

Operating voltage range

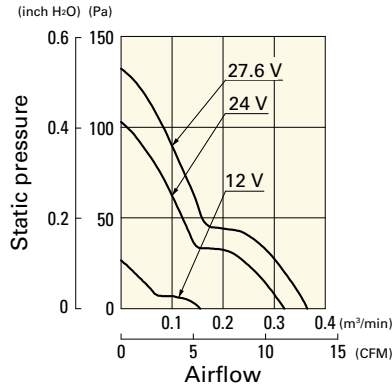

109P0424F3013 With pulse sensor

Operating voltage range

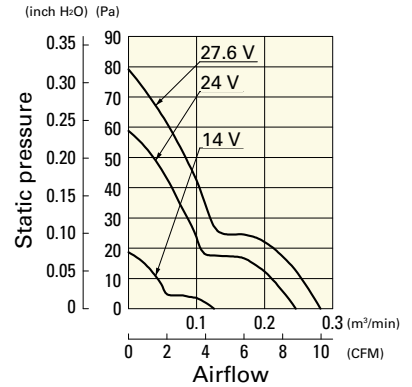

Dimensions (unit: mm)

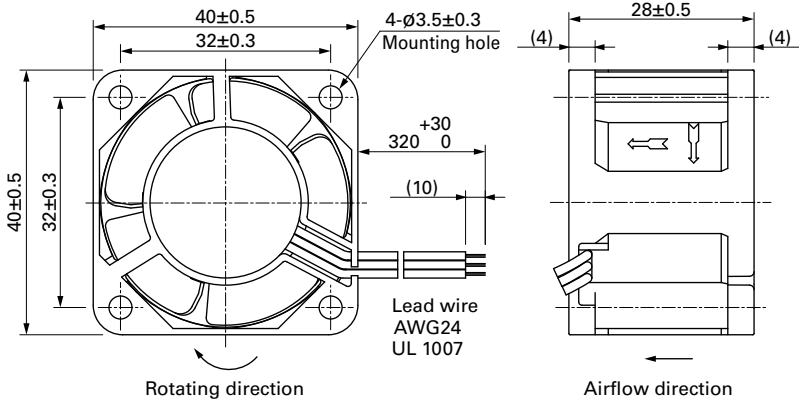

Reference Dimensions of Mounting Holes and Vent Opening (unit: mm)

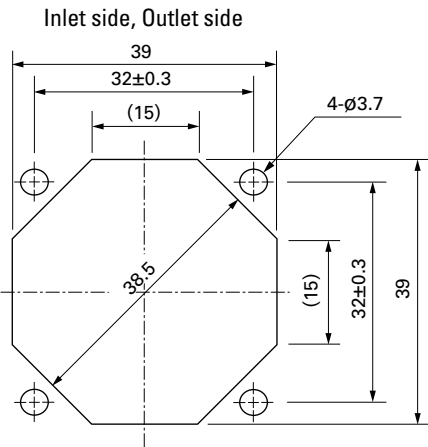

Options

Finger guards

page: p. 558

Model no.: 109-059, 109-059H