

External Dimensions

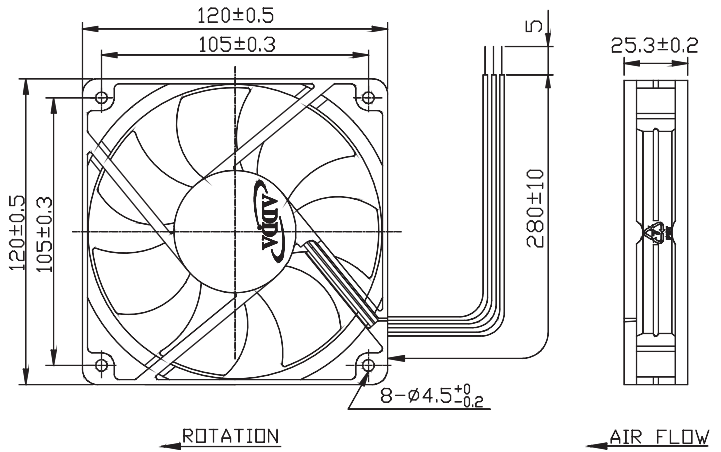

Frame:Plastic(UL:94V-0)
 Impeller:Plastic(UL:94V-0)
 Lead wire:UL1007AWG24

Specifications(Nominal)

*Noise is measured at the distance of one (1) meter from the axis of intake.

Bearing type: ◎=Ball ※=Sleeve ●=Hypro bearing

Frame size (mm)	Model No.	Bearing System Type	Rated Voltage (VDC)	Current (A)	Power (W)	Rated Speed (rpm)	Maximum AirFlow (CMM) (CFM)	Maximum Pressure (InAq) (mmAq)	*Noise Level (dB/A)	Weight (g)
120x120x25	AD1212DB-A7BGL	◎ ※ ●	12	0.11	1.32	1500	1.618 57.205	0.074 1.879	27.2	156.0
	AD1212LB-A7BGL	◎ ※ ●	12	0.15	1.80	1800	2.032 71.806	0.093 2.362	34.4	
	AD1212MB-A7BGL	◎ ※ ●	12	0.16	1.92	2050	2.293 81.054	0.113 2.870	38.0	
	AD1212HB-A7BGL	◎ ※ ●	12	0.29	3.48	2200	2.486 87.870	0.134 3.403	39.1	
	AD1212UB-A7BGL	◎ ※ ●	12	0.39	4.68	2500	2.800 98.965	0.174 4.419	43.3	
	AD1224DB-A7BGL	◎ ※ ●	24	0.07	1.68	1500	1.618 57.205	0.074 1.879	27.2	
	AD1224LB-A7BGL	◎ ※ ●	24	0.10	2.40	1800	2.032 71.806	0.093 2.362	34.4	
	AD1224MB-A7BGL	◎ ※ ●	24	0.13	3.12	2050	2.293 81.054	0.113 2.870	38.0	
	AD1224HB-A7BGL	◎ ※ ●	24	0.13	3.12	2200	2.486 87.870	0.134 3.403	39.1	
	AD1224UB-A7BGL	◎ ※ ●	24	0.19	4.56	2500	2.800 98.965	0.174 4.419	43.3	
	AD1248HB-A7BGL	◎ ※ ●	48	0.10	4.80	2200	2.486 87.870	0.134 3.403	39.1	
	AD1248UB-A7BGL	◎ ※ ●	48	0.12	5.76	2500	2.800 98.965	0.174 4.419	43.3	

Specifications subject to change without notice.



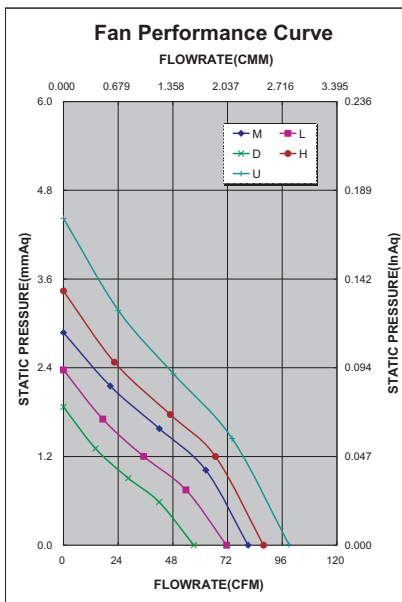

The specification for bearing type is for reference only, for more bearing types information, please contact with your ADDA sales representative, thanks!!
 (網頁上呈現產品軸承資訊均以2Ball為主, 若需其他產品資訊請聯絡您在ADDA的業務代表, 謝謝!!)



*Motor protective circuit and third lead wire functions

0	1	2	3	4	6	7	8	9	A	B
✓	✓	✓	✓	✓	✓		✓	✓		✓

*Safety approvals

				
✓	✓		✓	✓