



NSX - BPX Series

Arinc 600



Contents

NSX - ARINC		How to order NSX F/G/K	4-58
Introduction	4-4 to 4-5	NSX F/G/K Contacts	4-59 to 4-62
Application	4-6	Dimensions	4-63 to 4-77
Characteristics:		Panel cut out	4-78 to 4-79
- Technical characteristics	4-7	Tools	4-80 to 4-81
- Electrical	4-7	Accessories	4-82 to 4-89
- Mechanical & Environmental	4-7		
- Masses	4-8	NSX – SINGLE SHELL	
EMI/RFI performances	4-9	Introduction	4-90
- Material	4-9	Material	4-90
- Characteristics	4-9	How to order	4-91
Product overview	4-10	Installation	4-93 to 4-93
How to order	4-11	Dimensions	4-94 to 4-95
- Contact arrangement	4-12 to 4-21	Panel cut out	4-96
- Insert combination code	4-22 to 4-28	EMI/RFI shell dimension	4-97
- Modification code	4-29 to 4-30		
- Polarization code	4-31	BPX	
- Polarization code table	4-32 to 4-33	Introduction	4-98
Contacts:		Characteristics:	
- Signal, power and ground		- Electrical	4-98
contacts crimps termination	4-34 to 4-36	- Mechanical & Environmental	4-99
- Chromel contacts – crimp termination	4-37	- Materials	4-99
- Alumel contacts – crimp termination	4-38	How to order	4-100
- Coaxial contacts	4-39 to 4-51	Insert combination code	4-101
- Concentric twinax contacts	4-52	Contact	4-101
- Quadrax contacts	4-53	Accessories	4-102 to 4-104
- LuxCis® contacts	4-54 to 4-56	Dimensions	4-105 to 4-110
- NSX E/N/H/C – rear removable contacts	4-57	Panel cut out	4-111 to 4-112

SECTION 4 TABLE OF CONTENTS

Introduction

NSX AND BPX MULTICONTACT CONNECTORS

NSX series (defined by ARINC 600 specification) and **BPX** series (defined by Boeing S280W551 specification) are multipin rack and panel connectors used to connect high performance aeronautical equipment. Items in this catalog are covered by French and foreign Patents and/or Patents pending.

These two series manufactured by Radiall show the following characteristics:

- High contact density
- Wide range of contact types and arrangement
- Numerous shell polarization possibilities which give maximum security when mating the equipment in the rack
- Low mating forces
- Separation of power and signal contacts
- EMI/RFI shielding option provided by shell to shell conductivity

Major aircraft manufacturers and equipment manufacturers have been entrusting Radiall for many years using NSX and BPX series.

NSX SERIE (ARINC 600 STANDARD)

RADIALL NSX series offers the following versions included a new cost effective solution:

Connectors for **rear removable** contacts:

- **NSX N:** Plug and receptacle connectors.
Non environmental version, inserts without grommet and compound, plugs without groove and O-ring.
- **NSX C:** Plug and receptacle connectors.
Non environmental version, inserts with grommet but without compound, plugs without groove and O-ring.
- **NSX E:** Plug and receptacle connectors.
Environmental version, inserts with grommet and compound, plugs with groove and O-ring.
- **NSX H:** Plug connector only.
Environmental version, inserts with grommet and compound, plugs without groove and O-ring.

Connectors for **front removable** contacts:

- **NSX F:** Receptacle connectors only.
Only signal contacts are Front release/Front Removable (FR/FR), others will be Rear Release/Rear Removable (RR/RR). Non environmental version, inserts without grommet and compound.
- **NSX G:** Receptacle connectors only.
Signal, power, coax, triax and quadrax contacts are FR/FR.
Non environmental version, inserts without grommet and compound.
- **NSX K:** **New cost effective solution. 100% RoHS compliant for shell plating selection F and S.**
Receptacle connectors only.
Inserts fully completed with harpooned size 22 contacts
Non environmental version

As an option, EMI/RFI features are available to get shell to shell conductivity.

Introduction

SHELL

RADIALL NSX series offers three metallic shell sizes fitted with polarization hardware offering 216 polarizing possibilities.

NSX shells answer all requirements with three different platings, all compliant with ARINC 600 standard: alodine, nickel, RoHS.

The plug shell is fitted with inserts for signal (size 22) pin contacts, coax, triax and quadrax socket contacts. The receptacle shell is fitted with inserts for signal socket contacts, coax, triax and quadrax pin contacts.



INSERTS

Environmental inserts have a wire sealing grommet on the rear face and compound between insert and shell. The different kinds of inserts available are:

- Insert for rear release rear removable contacts (blue colored on the terminating face).
- Insert for front release front removable contacts (red colored on the mating face).
- Insert for front release rear removable contacts (yellow colored on the mating face).

CONTACTS

A whole range of crimp or PC tail contacts are available with NSX connectors: signal, coax, triax, quadrax or fiber optic contacts. Signal and power contacts were designed to be low insertion force contacts so that they are perfectly orientated into the cavities and contacts are not damaged when insertion is made. Front release and rear release inserts use contact retention system (clips) which meets the ARINC 600 contact retention requirements. This system allows contacts to be removed from the insert using an extraction tool

NEW COST EFFECTIVE SOLUTION

Radiall is constantly looking for cost saving solutions to answer our customers' expectations. Based on this concept, Radiall proudly introduces:

Inserts with harpooned contacts

Discover the new class K available for front removable contacts. They show the following features and benefits:

- Improved pricing stability and reduced dependence on fluctuating gold prices
- Lightweight solution as insert is one piece
- 100% intermateable with any ARINC 600 plug
- 100% backwards compatibility with existing PCB and PGA connectors
- RoHS compliant
- Fully qualified under Arinc 600 specification requirements

Selective plating contacts

A brand new range of PC tail contacts with gold selective plating is now available. They offer the following features and benefits:

- Significant reduction of cost of ownership
- N- more dependence t- gold rate fluctuation
- N- change in the contact integration process

Specifications:

- Same contact design as full plated version
- Contact interface gold plated with 1.27µm
- No impact on PCB design
- Product qualification is available upon request

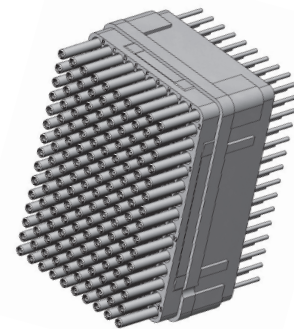

NSX - BPX SERIES

NSX SERIES

Application

These connectors are mostly used to connect high performance aeronautical equipment. Most of the NSX connectors are used in the main avionics bay on commercial airplanes. Electronic functions are found in an LRU (Line Replaceable Unit). Refer to Arinc 600 document for more information.

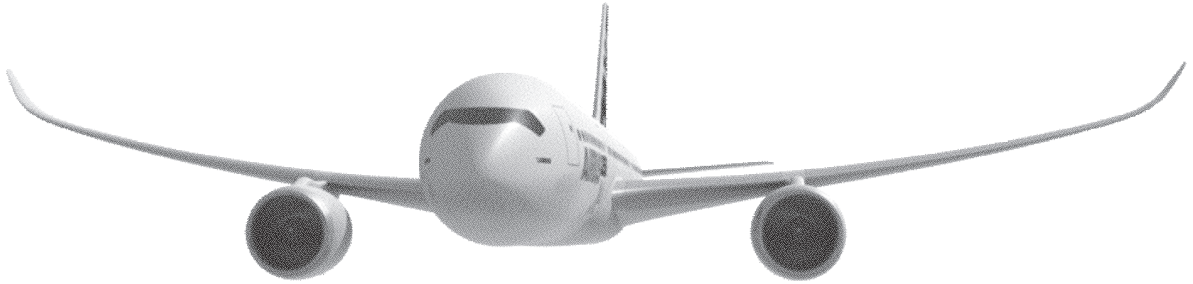

Characteristics

TECHNICAL CHARACTERISTICS

Description	Material	Plating
Shell	Aluminum alloy	Chromatation or nickel
Inserts	Thermosetting or thermoplastic	/
Metallic inserts	Aluminum alloy	Nickel
O-ring & grommet	Fluorosilicone	/
Contacts	Copper alloy	Gold over nickel
Retention clip	Copper alloy	/
Insert retention plate	Aluinium alloy	Blue anodized or nickel
Polarization posts and keys retention plate	Aluminum alloy	Chromatation or nickel
Screws washers and clinch-nuts	Stainless steel	/
	Steel	Cadmium yellow chromate
Polarization posts and keys	Zinc alloy	Nickel

ELECTRICAL CHARACTERISTICS

Contact size	Wire				Max current (A)
	AWG	Cross section (mm ²)	Outside Dia. mm (inches)		
			min.	max.	
22	22	0.38	0.66 (.026)	1.4 (.055)	5
	24	0.21			3
	26	0.14			2
20	20	0.60	1 (.040)	1.8 (.071)	7.5
	22	0.38			5
	24	0.21			3
16	16	1.34	1.7 (0.066)	2.6 (.102)	13
	18	0.93			10
	20	0.60			7.5
12	12	3.18	2.4 (.094)	3.4 (.134)	23
	14	1.91			17
	16	1.34			13
8	8	9	4.65 (.183)	6.48 (.255)	46
	10	5			33

MECHANICAL & ENVIRONMENTAL

- Temperature range: - 65°C/+125°C
- Temperature life: 1000 hours at 125 °C.
- Salt spray: MIL-STD-1344 method 1001.1 test condition B (48 hours).
- Moisture resistance: MIL-STD-1344 method 1002.1 test condition II (10 times 24 hours).
- Sealing: environment resistant to running water (environmental version only).
- Fluid resistance: resistance to MIL-STD-1344 method 1016 (fluids a, e, i).
- Durability: 500 mating and unmating cycles.
- Random vibration: conforming to MIL-STD-1344 method 2005.1 test condition 5 letter E. (16,4g from 50 to 2000 Hz, 8 hours per direction).
- Shock: 50g 11 ms half sine.MIL-STD-1344 method 2004.1 3 impacts per direction.
- Mating force: connector size 1 : 27 pounds (120 N) max,
connector size 2 : 60 pounds (267 N) max,
connector size 3 : 105 pounds (467 N) max.

CONTACT RETENTION FORCE

Contact size	22	20	16	12	8	Coax triax quadrax
Retention force min (ounces)	12	20	25	30	25	25

Characteristics

COAX CONTACTS ELECTRICAL CHARACTERISTICS

- Nominal impedance: 50Ω.
- DWV: 1500 VAC – IR at 25 °C = 5000 MΩ.
- V.S.W.R.: Size 5 → 1.3 from DC to 1500 MHz and insertion loss = 0.3 dB, Size 1 → 1.3 from DC to 5000 MHz

MASS G (OZ)

Shells

Includes screws, washers, insert retention plate and polarization hardware.

Plug			Receptacle		
Size 1	Size 2	Size 3	Size 1	Size 2	Size 3
110 (3.88)	130 (4.59)	220 (7.76)	130 (4.59)	140 (4.94)	245 (8.64)

INSERTS

Contact arrangement designation	For plug shell		For receptacle shell	
	Environmental type	Non-environmental type	Environmental type	Non-environmental type
5C2	15.25 (0.54)	12.39 (0.44)	9.92 (0.35)	7,25 (0,26)
40	13.52 (0.48)	11.15 (0.39)	9.22 (0.33)	8,22 (0,29)
60	18.78 (0.66)	15.53 (0.55)	12.78 (0.45)	11,43 (0,40)
30T2	17.86 (0.63)	14.75 (0.52)	11.38 (0.40)	9,36 (0,33)
150	41.80 (1.47)	20.87 (0.74)	28.01 (0.99)	24,32 (0,86)
121	45.93 (1.62)	37.79 (1.33)	29.77 (1.05)	24,53 (0,87)
120T2	41.21 (1.45)	34.12 (1.20)	26.89 (0.95)	23,83 (0,84)
71C1/1C71	31.4 (1.11)	27.7 (0.98)	19.73 (0.70)	18,68 (0,66)
60	58.87 (2.08)	48.97 (1.73)	35.69 (1.26)	25,79 (0,91)
10T10	51.80 (1.83)	45.45 (1.60)	32.76 (1.16)	26,41 (0,93)
C4	/	31.56 (1.11)	/	20,96 (0,74)
C2	/	25.94 (0.91)	/	12,48 (0,44)
100	30.63 (1.08)	25.31 (0.89)	20.56 (0.73)	17,8 (0,63)
85	33.01 (1.16)	27.15 (0.96)	21.67 (0.76)	18,67 (0,66)
34	41.56 (1.47)	34.57 (1.22)	25.06 (0.88)	18,06 (0,64)
13C2	39.96 (1.41)	33.36 (1.18)	24.48 (0.86)	17,89 (0,63)
6T6	41.48 (1.46)	36.52 (1.29)	25.53 (0.90)	31,24 (1,10)
Q11	36.86 (1.30)	31.26 (1.10)	25.07 (0.88)	19,47 (0,69)
62Q2	31.85 (1.12)	26.24 (0.93)	/	13,2 (0,47)
68Q2	31.14 (1.10)	25.64 (0.90)	19.12 (0.67)	16,32 (0,58)
11Q2	37.39 (1.32)	30.88 (1.09)	24.38 (0.86)	17,87 (0,63)

CONTACTS

Contact size	Pin	Socket
22	0.12 (4 10 ⁻³)	0.15 (5.3 10 ⁻³)
20	0.22 (7.8 10 ⁻³)	0.40 (14.1 10 ⁻³)
16	0.72 (25.4 10 ⁻³)	0.75 (26.5 10 ⁻³)
12	1.50 (53.0 10 ⁻³)	1.50 (53.0 10 ⁻³)
8	619270: 5 (0.18) 619271: 6.5 (0.23)	

EMI/RFI Performances

EMI/RFI acts directly on electronics systems whether by conduction through the input or input cables or by induction (coupling).

Electronics equipment are particularly vulnerable to interferences and can be disturbed or damaged by them. The serious consequences which may result, make it essential to protect such installations.

The first stage in protection is to install the equipment in a metal surrounding (FARADAY cage) which protects it from some of the interferences; particularly those occurring by induction.

As to meet these requirements **RADIALL** offers plug connectors for racks which are fitted with ground spring fingers.

Sizes 1, 2 and 3 plugs connectors fitted with ground spring fingers are available. These connectors can be mated with ARINC 600 receptacle connectors. Their technical characteristics are the same than those shown on page 4-8 except the following.

MATERIALS

Description	Material	Plating
Shell	Aluminum alloy	Electroless nickel
Ground spring fingers	Copper alloy	Electroless nickel

ELECTRICAL CHARACTERISTICS

- **Shell to shell conductivity:**
(measured according to method 3007 of MIL-STD-1344A),
max warranty: 2,5 mΩ.
- **Size 8 cavity grounding:**
(measured according to method 3007 of MIL-STD-1344A),
max warranty: 10,0 mΩ.
- **EMI shielding effectiveness:**
(measured according to S280W552).
The minimum values warranty are as follows: Typical values

Frequency (mhz)	Leakage attenuation (db)
100	65
200	63
300	63
400	62
800	60
1000	60

NSX SERIES

Product Overview

Detailed view of the various parts of the NSX connector series.

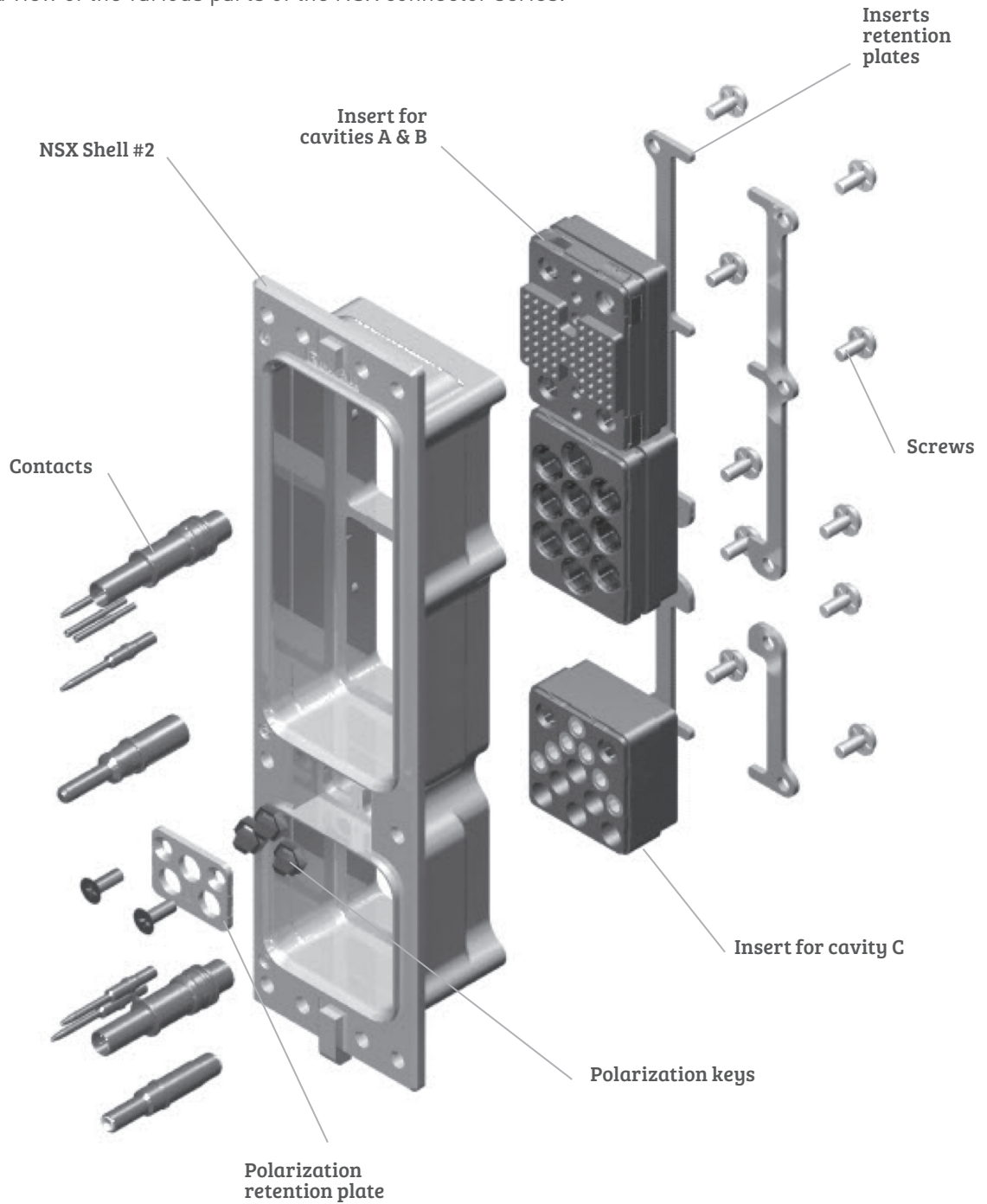

How to Order

NSX E/N/H/C – CONNECTORS FOR REAR REMOVABLE CONTACTS

NSX	N	3	P	301	X	00	01	-
-----	---	---	---	-----	---	----	----	---

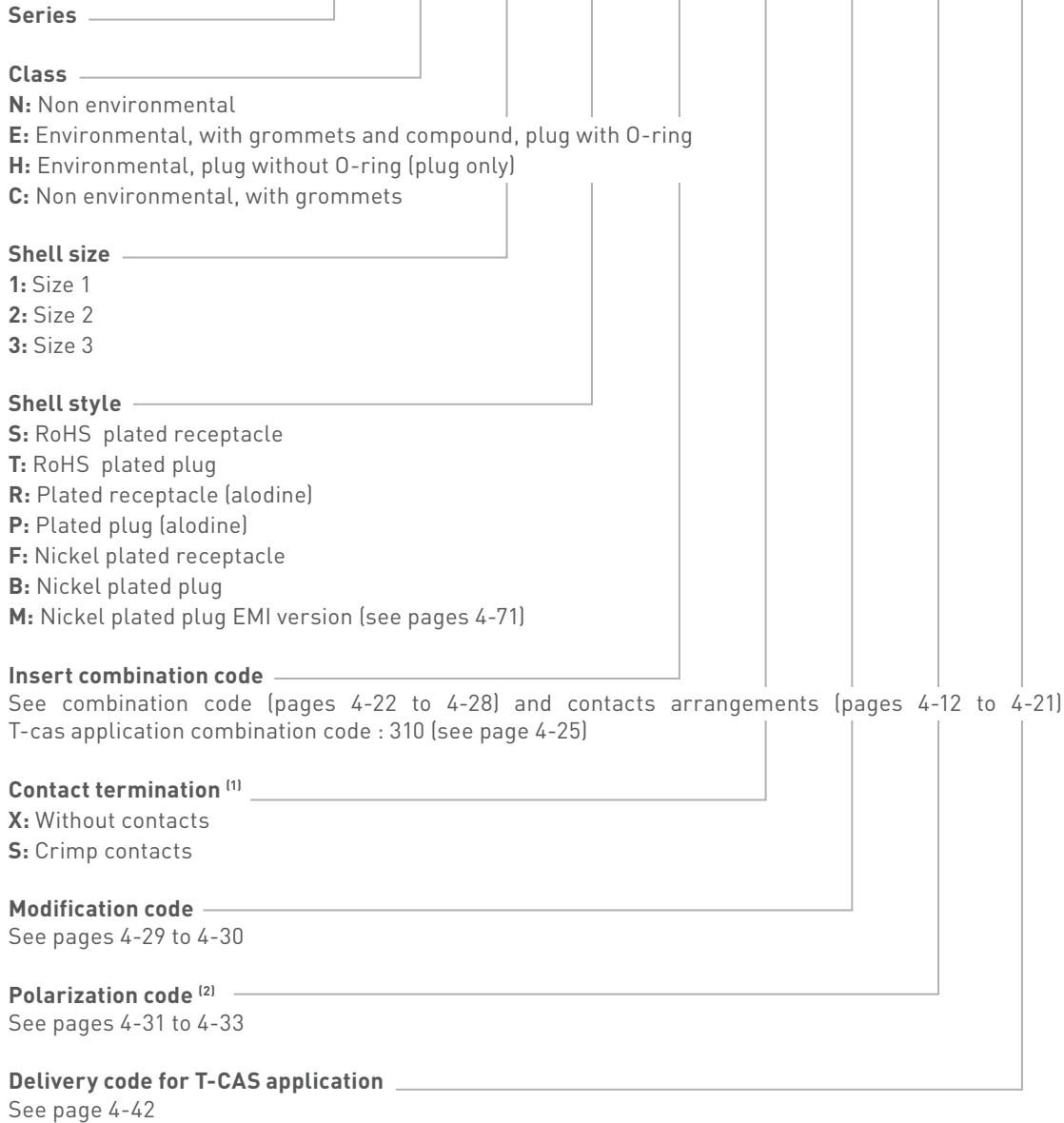



















NOTES:

- (1) If you need to use reduced crimp barrel contacts, use code X and order signal and power contacts separately. Coax, twinax or power size 5 or 8, coax size 1 must always be ordered separately
- (2) Without polarization code, the connector is delivered with polarization hardware unassembled. Polarization code 00, the connector is delivered without polarizing hardware. Polarization code from 01 to 216, the connector is delivered with the polarization hardware assembled as defined by code

REMARK: dust caps conductive on receptacle and non conductive on plug are included in the delivery

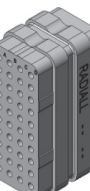
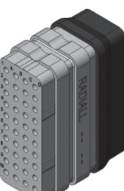
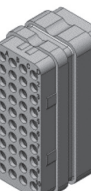
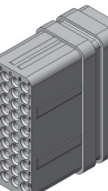
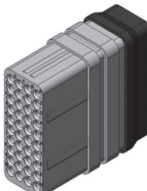
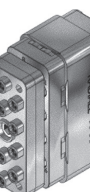









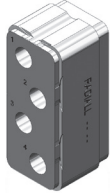









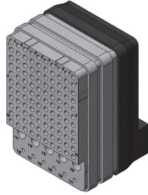
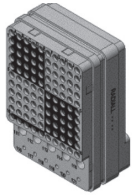
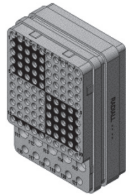

NSX Shell Contact Arrangement

All insert names including letter Q can be equipped with quadrax contacts for each insert arrangement the quantity and type of contacts is shown with insert view. RR/RR means contacts are rear release and rear removable. FR/FR means contacts are front release and front removable. The letter G means that the contact will be used in grounded cavity. LuxCis® contacts are always rear release and rear removable. N/A means not available, please contact Radiall for further details.

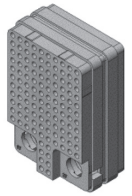
Insert name	Shell size cavity	Equipment side receptacle shell				Avionic side plug shell	
		Version N	Version E	Version F	Version G	Version N	Version E
60	1-A/B	 60x#22 RR/RR	 60x#22 RR/RR	 60x#22 FR/FR	N/A	 60x#22 RR/RR	 60x#22 RR/RR
30T2	1-A/B	 28x#22 RR/RR 2x#8G RR/RR	 28x#22 RR/RR 2x#8G RR/RR	 28x#22 FR/FR 2x#8G RR/RR	 28x#22 FR/FR 2x#8G FR/FR	 28x#22 RR/RR 2x#8G RR/RR	 28x#22 RR/RR 2x#8G RR/RR
4C	1-A/B	 4x#5G RR/RR	N/A	N/A	 4x#5G FR/FR	 4x#5G RR/RR	N/A
40	1-C	 40x#22 RR/RR	 40x#22 RR/RR	 40x#22 FR/FR	N/A	 40x#22 RR/RR	 40x#22 RR/RR
12F12	1-C	 h12x#16 RR/RR LuxCis®	 12x#16 RR/RR LuxCis®	N/A	N/A	 12x#16 RR/RR LuxCis®	 12x#16 RR/RR LuxCis®

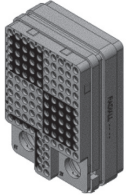
NSX Shell Contact Arrangement

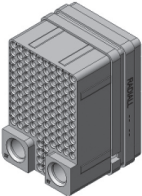









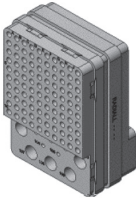
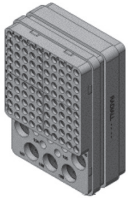
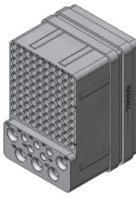

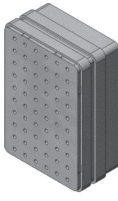



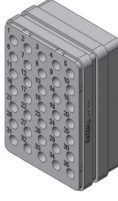

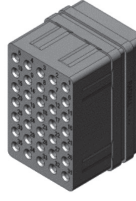
NSX SERIES

Insert name	Shell size cavity	Equipment side receptacle shell				Avionic side plug shell	
		Version N	Version E	Version F	Version G	Version N	Version E
4	1-C	 4x#12 RR/RR ⁽¹⁾	Available (1)	N/A	N/A	 4x#12 RR/RR	 4x#12 RR/RR
5C2	1-C	 2x#5 RR/RR 1x#12 RR/RR 2x#16 RR/RR	 2x#5 RR/RR 1x#12 RR/RR 2x#16 RR/RR	N/A	 2x#5 FR/FR 1x#12 FR/FR 2x#16 FR/FR	 2x#5 RR/RR 1x#12 RR/RR 2x#16 RR/RR	 2x#5 RR/RR 1x#12 RR/RR 2x#16 RR/RR
150	2/3-A/B	 150x#22 RR/RR	 150x#22 RR/RR	 150x#22 FR/FR	N/A	 150x#22 RR/RR	 150x#22 RR/RR
121	2/3-A/B	 110x#22 RR/RR 6x#20 RR/RR 5x#16 RR/RR	 110x#22 RR/RR 6x#20 RR/RR 5x#16 RR/RR	 110x#22 FR/FR 6x#20 RR/RR 5x#16 RR/RR	 110x#22 FR/FR 6x#20 FR/FR 5x#16 FR/FR	 110x#22 RR/RR 6x#20 RR/RR 5x#16 RR/RR	 110x#22 RR/RR 6x#20 RR/RR 5x#16 RR/RR
120T2	2/3-A/B	 118x#22 RR/RR 2x#8G RR/RR	 118x#22 RR/RR 2x#8G RR/RR	 118x#22 FR/FR 2x#8G RR/RR	 118x#22 FR/FR 2x#8G FR/FR	 118x#22 RR/RR 2x#8G RR/RR	 118x#22 RR/RR 2x#8G RR/RR

NOTE:
(1) For BPX serie, 4 insert will be supplied with FR/RR contacts.

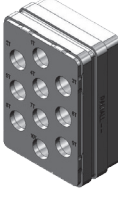
NSX SERIES

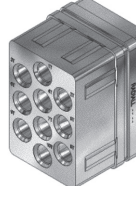
NSX Shell Contact Arrangement







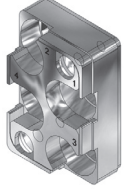
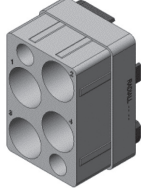

Insert name	Shell size cavity	Equipment side receptacle shell				Avionic side plug shell	
		Version N	Version E	Version F	Version G	Version N	Version E
110	2/3-A/B	 100x#22 RR/RR 5x#20 RR/RR 5x#12 RR/RR	N/A	N/A	 100x#22 FR/FR 5x#20 FR/FR 5x#12 FR/FR	 100x#22 RR/RR 5x#20 RR/RR 5x#12 RR/RR	 100x#22 RR/RR 5x#20 RR/RR 5x#12 RR/RR
60A	2/3-A/B	 60x#20 RR/RR	 60x#20 RR/RR	N/A	 60x#20 FR/FR	 60x#20 RR/RR	 60x#20 RR/RR
35	2/3-A/B	 35x#16 RR/RR	 35x#16 RR/RR	N/A	 35x#16 FR/FR	 35x#16 RR/RR	 35x#16 RR/RR
24	2/3-A/B	 24x#12 RR/RR	 24x#12 RR/RR	N/A	 24x#12 FR/FR	 24x#12 RR/RR	 24x#12 RR/RR
10T10	2/3-A/B	 10x#8G RR/RR (1)	Available	N/A (1)	 10x#8G FR/FR	 10x#8G RR/RR	 10x#8G RR/RR

NOTE:

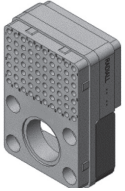
(1) For BPX serie, 10T10 insert will be supplied with FR/RR contacts.

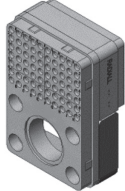
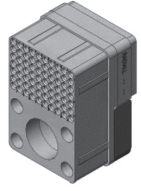

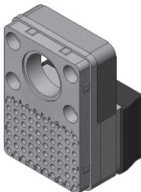

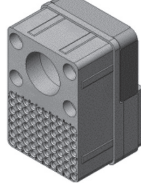
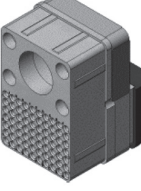





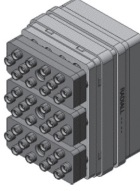
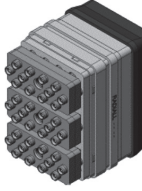
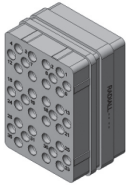

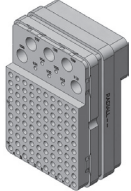

NSX Shell Contact Arrangement

NSX SERIES

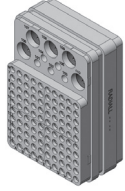
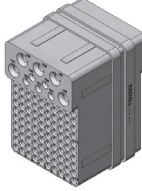
Insert name	Shell size cavity	Equipment side receptacle shell				Avionic side plug shell	
		Version N	Version E	Version F	Version G	Version N	Version E
C4	2/3-A/B	 4x#1G FR/RR	N/A	N/A	 4x#1G FR/FR	 4x#1G FR/RR	N/A
C2	2/3-A/B	 2x#1G FR/RR	N/A	N/A	N/A	 2x#1G FR/RR	N/A
71C1	2/3-A/B	 70x#22 RR/RR 1x#1 FR/RR	 70x#22 RR/RR 1x#1 FR/RR	 70x#22 RR/RR 1x#1 FR/RR	N/A	 70x#22 RR/RR 1x#1 FR/RR	 70x#22 RR/RR 1x#1 FR/RR
1C71	2/3-A/B	 70x#22 RR/RR 1x#1 FR/RR	 70x#22 RR/RR 1x#1 FR/RR	 70x#22 FR/FR 1x#1 FR/RR	N/A	 70x#22 RR/RR 1x#1 FR/RR	 70x#22 RR/RR 1x#1 FR/RR











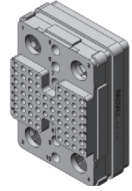

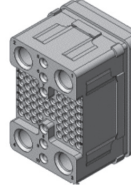
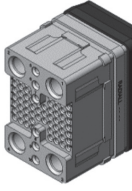
NSX SERIES

NSX Shell Contact Arrangement

Insert name	Shell size cavity	Equipment side receptacle shell				Avionic side plug shell	
		Version N	Version E	Version F	Version G	Version N	Version E
36F36	2/3-A/B	 36x#16 RR/RR LuxCis®	 36x#16 RR/RR LuxCis®	N/A	N/A	 36x#16 RR/RR LuxCis®	 36x#16 RR/RR LuxCis®
20F12Q8	2/3-A/B	 12x#16 RR/RR LuxCis® 8x#8G RR/RR	 12x#16 RR/RR LuxCis® 8x#8G RR/RR	N/A	 12x#16 RR/RR LuxCis® 8x#8G FR/FR	 12x#16 RR/RR LuxCis® 8x#8G RR/RR	 12x#16 RR/RR LuxCis® 8x#8G RR/RR
110R	2/3-A/B	 100x#22 RR/RR 5#20 RR/RR 5#12 RR/RR	 100x#22 RR/RR 5#20 RR/RR 5#12 RR/RR	N/A	 100x#22 FR/FR 5#20 FR/FR 5#12 FR/FR	 100x#22 RR/RR 5#20 RR/RR 5#12 RR/RR	 100x#22 RR/RR 5#20 RR/RR 5#12 RR/RR
Q11	2/3-A/B	 11x#8G RR/RR	 11x#8G RR/RR	N/A	 11x#8G FR/FR	 11x#8G RR/RR	 11x#8G RR/RR

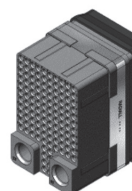
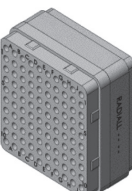

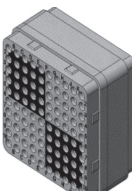
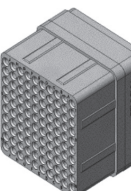

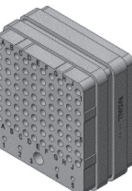
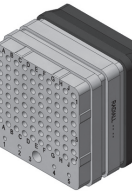
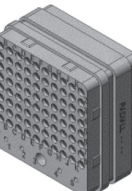
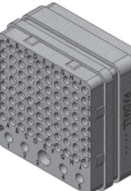
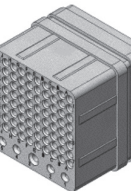
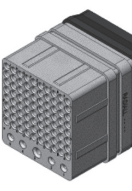
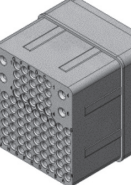
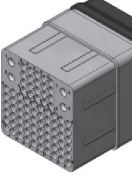

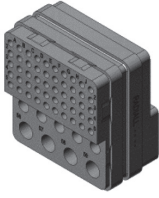

NSX Shell Contact Arrangement

NSX SERIES

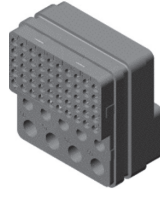
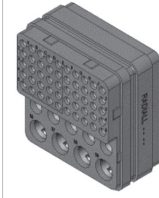
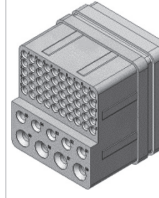
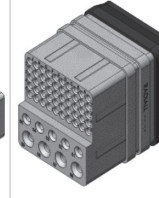
Insert name	Shell size cavity	Equipment side receptacle shell				Avionic side plug shell	
		Version N	Version E	Version F	Version G	Version N	Version E
68Q4	2/3-A/B	 62x#22 RR/RR 6x#16 RR/RR 4x#8G RR/RR	 62x#22 RR/RR 6x#16 RR/RR 4x#8G RR/RR	N/A	N/A	 62x#22 RR/RR 6x#16 RR/RR 4x#8G RR/RR	 62x#22 RR/RR 6x#16 RR/RR 4x#8G RR/RR
118Q2	2/3-A/B	 118x#22 RR/RR 2x#8G RR/RR	 118x#22 RR/RR 2x#8G RR/RR	 118x#22 FR/FR 2x#8G RR/RR	 118x#22 FR/FR 2x#8G FR/FR	 118x#22 RR/RR 2x#8G RR/RR	 118x#22 RR/RR 2x#8G RR/RR
100	2/3-C	 100x#22 RR/RR	 100x#22 RR/RR	 100x#22 FR/FR	N/A	 100x#22 RR/RR	 100x#22 RR/RR
85	2/3-C	 80x#22 RR/RR 4x#20 RR/RR 1x#16 RR/RR	 80x#22 RR/RR 4x#20 RR/RR 1x#16 RR/RR	 80x#22 FR/FR 4x#20 RR/RR 1x#16 RR/RR	 80x#22 FR/FR 4x#20 FR/FR 1x#16 FR/FR	 80x#22 RR/RR 4x#20 RR/RR 1x#16 RR/RR	 80x#22 RR/RR 4x#20 RR/RR 1x#16 RR/RR
84	2/3-C	N/A	N/A	N/A	N/A	 80x#22 RR/RR 4x#20 RR/RR	 80x#22 RR/RR 4x#20 RR/RR

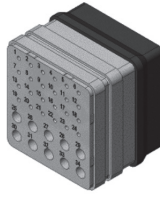
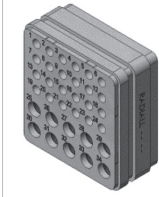
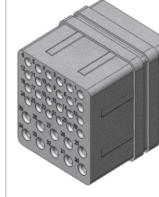
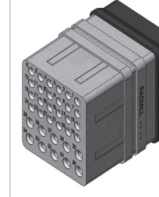
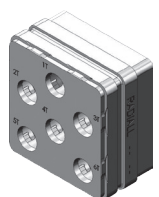
NSX SERIES

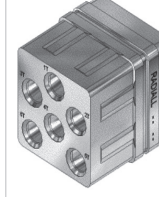
NSX Shell Contact Arrangement

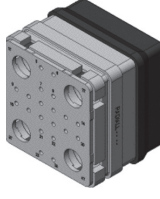
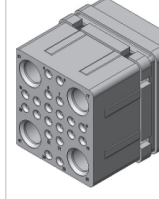
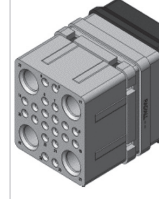



Insert name	Shell size cavity	Equipment side receptacle shell				Avionic side plug shell	
		Version N	Version E	Version F	Version G	Version N	Version E
59	2/3-C	 50x#22 RR/RR 5x#16 RR/RR 4x#12 RR/RR	 50x#22 RR/RR 5x#16 RR/RR 4x#12 RR/RR	 50x#22 FR/FR 5x#16 RR/RR 4x#12 RR/RR	 50x#22 FR/FR 5x#16 FR/FR 4x#12 FR/FR	 50x#22 RR/RR 5x#16 RR/RR 4x#12 RR/RR	 50x#22 RR/RR 5x#16 RR/RR 4x#12 RR/RR
34	2/3-C	 24x#20 RR/RR 10x#16 RR/RR	 24x#20 RR/RR 10x#16 RR/RR	N/A	 24x#20 FR/FR 10x#16 FR/FR	 24x#20 RR/RR 10x#16 RR/RR	 24x#20 RR/RR 10x#16 RR/RR
6T6	2/3-C	 6x#8G RR/RR ⁽¹⁾	Available ⁽¹⁾	N/A	 6x#8G FR/FR	 6x#8G RR/RR	 6x#8G RR/RR
24T4	2/3-C	 20x#20 RR/RR 4x#8G RR/RR	 20x#20 RR/RR 4x#8G RR/RR	N/A	N/A	 20x#20 RR/RR 4x#8G RR/RR	 20x#20 RR/RR 4x#8G RR/RR

NOTE:

(1) For BPX serie, 6T6 insert will be supplied with FR/RR contacts

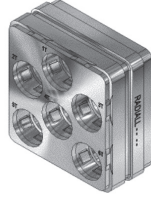

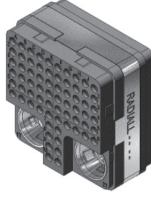
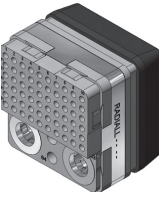













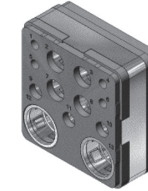

NSX Shell Contact Arrangement

NSX SERIES

Insert name	Shell size cavity	Equipment side receptacle shell				Avionic side plug shell	
		Version N	Version E	Version F	Version G	Version N	Version E
Q6	2/3-C	 6x#8G RR/RR	 6x#8G RR/RR	N/A	 6x#8G FR/FR	 6x#8G RR/RR	 6x#8G RR/RR
20Q4	2/3-C	 20x#20 RR/RR 4x#8G RR/RR	 20x#20 RR/RR 4x#8G RR/RR	N/A	 20x#20 FR/FR 4x#8G FR/FR	 20x#20 RR/RR 4x#8G RR/RR	 20x#20 RR/RR 4x#8G RR/RR
68Q2	2/3-C	 68x#22 RR/RR 2x#8G RR/RR	 68x#22 RR/RR 2x#8G RR/RR	N/A	 68x#22 FR/FR 2x#8G FR/FR	 68x#22 RR/RR 2x#8G RR/RR	 68x#22 RR/RR 2x#8G RR/RR
62Q2	2/3-C	 60x#22 RR/RR 2x#16 RR/RR 2x#8G RR/RR	 60x#22 RR/RR 2x#16 RR/RR 2x#8G RR/RR	N/A	 60x#22 FR/FR 2x#16 FR/FR 2x#8G FR/FR	 60x#22 RR/RR 2x#16 RR/RR 2x#8G RR/RR	 60x#22 RR/RR 2x#16 RR/RR 2x#8G RR/RR
17F12Q2	2/3-C	 12x#16 RR/RR LuxCis® 3x#16 RR/RR 2x#8G RR/RR	 12x#16 RR/RR LuxCis® 3x#16 RR/RR 2x#8G RR/RR	N/A	 12x#16 RR/RR LuxCis® 3x#16 FR/FR 2x#8G FR/FR	 12x#16 RR/RR LuxCis® 3x#16 RR/RR 2x#8G RR/RR	 12x#16 RR/RR LuxCis® 3x#16 RR/RR 2x#8G RR/RR

NSX SERIES

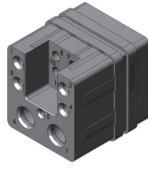
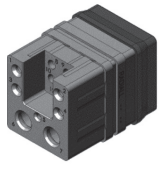
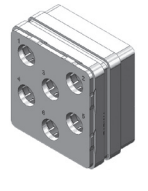
NSX Shell Contact Arrangement







Insert name	Shell size cavity	Equipment side receptacle shell				Avionic side plug shell	
		Version N	Version E	Version F	Version G	Version N	Version E
11Q2	2/3-C	 4x#20 RR/RR 3x#16 RR/RR 4x#12 RR/RR 2x#8G RR/RR	 4x#20 RR/RR 3x#16 RR/RR 4x#12 RR/RR 2x#8G RR/RR	N/A	 4x#20 FR/FR 3x#16 FR/FR 4x#12 FR/FR 2x#8G FR/FR	 4x#20 RR/RR 3x#16 RR/RR 4x#12 RR/RR 2x#8G RR/RR	 4x#20 RR/RR 3x#16 RR/RR 4x#12 RR/RR 2x#8G RR/RR
11WQ2	2/3-C	 4x#20 RR/RR 3x#16 RR/RR 4x#12 RR/RR 2x#8G RR/RR	 4x#20 RR/RR 3x#16 RR/RR 4x#12 RR/RR 2x#8G RR/RR	N/A	 4x#20 FR/FR 3x#16 FR/FR 4x#12 FR/FR 2x#8G FR/FR	 4x#20 RR/RR 3x#16 RR/RR 4x#12 RR/RR 2x#8G RR/RR	 4x#20 RR/RR 3x#16 RR/RR 4x#12 RR/RR 2x#8G RR/RR
13C2	2/3-C	 4x#20 RR/RR 3x#16 RR/RR 4x#12 RR/RR 2x#5 RR/RR	 4x#20 RR/RR 3x#16 RR/RR 4x#12 RR/RR 2x#5 RR/RR	N/A	 4x#20 FR/FR 3x#16 FR/FR 4x#12 FR/FR 2x#5 FR/FR	 4x#20 RR/RR 3x#16 RR/RR 4x#12 RR/RR 2x#5 RR/RR	 4x#20 RR/RR 3x#16 RR/RR 4x#12 RR/RR 2x#5 RR/RR
12F5C2	2/3-C	 1x#16 RR/RR 5x#16 RR/RR LuxCis® 4x#12 RR/RR 2x#5 RR/RR	 1x#16 RR/RR 5x#16 RR/RR LuxCis® 4x#12 RR/RR 2x#5 RR/RR	N/A	N/A	 1x#16 RR/RR 5x#16 RR/RR LuxCis® 4x#12 RR/RR 2x#5 RR/RR	 1x#16 RR/RR 5x#16 RR/RR LuxCis® 4x#12 RR/RR 2x#5 RR/RR
6P6	2/3-C	 6x#8 RR/RR ⁽¹⁾	Available ⁽¹⁾	N/A	N/A	 6x#8 RR/RR	 6x#8 RR/RR

NOTE:

(1) For BPX series, 6P6 insert will be supplied with FR/RR contacts

NSX Shell Contact Arrangement

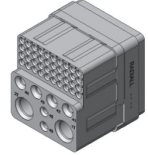
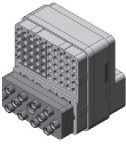
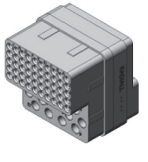
NSX SERIES

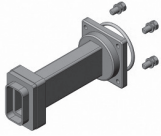
Insert name	Shell size cavity	Equipment side receptacle shell				Avionic side plug shell	
		Version N	Version E	Version F	Version G	Version N	Version E
15T6Q2	2/3-C	 <p>7x#16 RR/RR 6x#10 RR/RR 2x#8G RR/RR</p>	N/A	N/A	 <p>7x#16 FR/FR 6x#10 FR/FR 2x#8G FR/FR</p>	 <p>7x#16 RR/RR 6x#10 RR/RR 2x#8G RR/RR</p>	N/A
46Q2	2/3-C	 <p>40x#22 RR/RR 2x#16 RR/RR 4x#12 RR/RR 2x#8G RR/RR</p>	N/A	N/A	 <p>40x#22 FR/FR 2x#16 FR/FR 4x#12 FR/FR 2x#8G FR/FR</p>	 <p>40x#22 RR/RR 2x#16 RR/RR 4x#12 RR/RR 2x#8G RR/RR</p>	N/A
62F12	2/3-C	N/A	N/A	 <p>50x#22 FR/FR 12x#16 RR/RR LuxCis®</p>	N/A	 <p>50x#22 RR/RR 12x#16 RR/RR LuxCis®</p>	 <p>50x#22 RR/RR 12x#16 RR/RR LuxCis®</p>
WAVE GUIDE	2 - A&B	 <p>Wave guide equipment side</p>				 <p>Wave guide avionic side</p>	

Insert Combination Code

FOR SHELL SIZE 1

Code	Insert combination on shell		
	Cavity A	Cavity B	Cavity C
101	60	60	5C2
102	60	60	BLANK
103	BLANK	60	5C2
104	60	BLANK	5C2
105	BLANK	BLANK	5C2
106	60	BLANK	BLANK
107	30T2	30T2	40
108	60	60	40
109	BLANK	60	BLANK

Code	Insert combination on shell		
	Cavity A	Cavity B	Cavity C
111	BLANK	30T2	40
112	60	4C	5C2
113	60	4C	40
114	60	BLANK	40
115	BLANK	BLANK	BLANK
116	4C	60	40
117	BLANK	BLANK	40
118	60	30T2	5C2
119	30T2	BLANK	5C2

Code	Insert combination on shell		
	Cavity A	Cavity B	Cavity C
120	60	30T2	40
121	4C	4C	40
122	30T2	60	5C2
123	60	60	12F12
124	4C	BLANK	12F12
125	BLANK	BLANK	12F12

FOR SHELL SIZE 2

Code	Insert combination on shell		
	Cavity A	Cavity B	Cavity C
201	150	150	13C2
202	71C1	150	13C2
203	71C1	71C1	13C2
204	wave guide	150	13C2
205	150	71C1	13C2
206	150	150	100
207	71C1	150	100
208	150	71C1	100
209	71C1	71C1	100
210	wave guide	71C1	100
211	150	150	BLANK
212	71C1	71C1	BLANK
213	71C1	wave guide	13C2
214	wave guide	71C1	13C2
215	150	73C3	13C2
216	C2	1C71	85
217	150	C5	13C2
218	150	wave guide	13C2
219	150	2C	13C2
220	71C1	C2	85
221	1C71	71C1	13C2
222	BLANK	150	13C2
223	BLANK	BLANK	13C2
224	150	BLANK	13C2
225	150	71C1	BLANK
226	150	150	85
227	150	150	34
228	C4	150	13C2
229	120T2	120T2	100

Code	Insert combination on shell		
	Cavity A	Cavity B	Cavity C
230	121	121	6T6
233	120T2	150	100
234	60A	60A	13C2
235	150	C4	34
236	C4	C4	34
237	150	120T2	100
243	150	BLANK	100
244	150	BLANK	BLANK
245	71C1	71C1	85
246	71C1	BLANK	BLANK
247	BLANK	150	85
248	BLANK	150	100
249	BLANK	150	BLANK
250	BLANK	71C1	BLANK
251	BLANK	BLANK	100
252	BLANK	wave guide	100
253	C2	150	13C2
254	C2	1C71	100
255	C2	1C71	13C2
256	C2	71C1	13C2
257	C2	C2	13C2
258	-	-	-
259	C4	C4	85
260	wave guide	150	85
261	wave guide	150	100
262	150	60A	34
264	BLANK	24	100
265	24	150	13C2
266	121	121	85

Code	Insert combination on shell		
	Cavity A	Cavity B	Cavity C
268	60A	121	59
270	150	150	59
271	C4	120T2	13C2
272	150	150	24T4
273	150	C2	13C2
274	C2	71C1	85
275	121	60A	34
276	121	BLANK	100
277	1C71	150	13C2
278	71C1	1C71	13C2
279	150	121	13C2
280	120T2	121	34
281	150	121	34
282	C4	BLANK	13C2
283	150	60A	13C2
284	120T2	120T2	13C2
285	24	60A	100
286	60A	60A	34
287	BLANK	60A	100

Insert Combination Code

FOR SHELL SIZE 2

Code	Insert combination on shell		
	Cavity A	Cavity B	Cavity C
288	BLANK	121	BLANK
289	BLANK	BLANK	85
290	150	121	100
291	121	150	100
292	121	121	BLANK
294	121	121	13C2
295	Q11	Q11	85
297	120T2	60A	BLANK
298	121	60A	BLANK
299	BLANK	BLANK	59
501	24	60A	59
502	121	Q11	Q6
503	150	BLANK	11Q2
504	150	BLANK	34
505	Q11	BLANK	34
506	150	150	11Q2
507	150	150	68Q2
508	24	24	100
509	150	Q11	13C2
510	121	121	100
511	24	150	100
512	Q11	Q11	62Q2
513	Q11	Q11	34
514	BLANK	60A	34
515	BLANK	BLANK	BLANK
516	121	121	34
517	BLANK	120T2	13C2
518	Q11	BLANK	62Q2
519	Q11	Q11	68Q2
520	150	121	24T4
521	Q11	150	62Q2
522	20F12T8	120T2	13C2
524	120T2	120T2	11Q2
527	120T2	120T2	85
528	150	150	11WQ2

Code	Insert combination on shell		
	Cavity A	Cavity B	Cavity C
529	35	35	62Q2
530	24	BLANK	85
532	20F12T8	121	34
533	120T2	C4	24T4
534	BLANK	Q11	85
535	150	35	24T4
536	BLANK	150	24T4
537	118Q2	118Q2	24T4
538	150	120T2	13C2
539	Q11	Q11	BLANK
540	120T2	C4	13C2
541	1C71	Q11	13C2
542	121	C4	Q6
543	120T2	Q11	13C2
544	120T2	120T2	24T4
545	C4	Q11	85
546	121	60A	100
547	BLANK	150	20Q4
548	150	35	20Q4
551	121	118Q2	24T4
552	150	Q11	11Q2
554	BLANK	118Q2	13C2
555	BLANK	71C1	13C2
556	BLANK	BLANK	62Q2
557	BLANK	Q11	62Q2
558	BLANK	Q11	BLANK
559	150	150	20Q4
560	150	Q11	85
561	150	120T2	85
562	121	BLANK	BLANK
563	24	24	34
564	BLANK	BLANK	34
565	150	24	34
566	150	121	BLANK
567	150	118Q2	BLANK

Code	Insert combination on shell		
	Cavity A	Cavity B	Cavity C
569	118Q2	118Q2	BLANK
570	Q11	150	11Q2
571	150	118Q2	13C2
572	150	C4	13C2
573	150	24	13C2
574	150	121	59
575	60A	150	34
576	150	150	Q6
577	1C71	118Q2	12F5C2
578	150	121	20Q4
579	C4	118Q2	85
580	150	BLANK	59
581	118Q2	118Q2	20Q4
582	BLANK	71C1	11Q2
584	121	121	59
585	20F12Q8	BLANK	11Q2
586	150	Q11	34
587	150	118Q2	85
588	Q11	Q11	11Q2
590	BLANK	Q11	Q6
591	20F12T8	150	100
592	BLANK	BLANK	11Q2
593	20F12Q8	121	BLANK
594	C	118Q2	85
596	BLANK	118Q2	11WQ2
597	150	121	Q6
598	20F12Q8	118Q2	13C2
599	C4	24	100
801	C4	Q11	59
802	BLANK	120T2	24T4
803	Q11	20F12Q8	11Q2
804	Q11	20F12Q8	17F12Q2
806	C4	60A	59
807	Q11	150	85
809	C4	C4	59

NSX SERIES

Insert Combination Code

FOR SHELL SIZE 2

Code	Insert combination on shell		
	Cavity A	Cavity B	Cavity C
810	Q11	Q11	13C2
811	150	150	12F5C2
812	60A	C2	13C2
813	BLANK	Q11	13C2
814	120T2	150	13C2
815	60A	35	24T4
817	20F12Q8	Q11	62Q2
818	60A	C2	24T4
819	60A	24	34
820	Q11	121	BLANK
822	Q11	35	100
823	20F12T8	118Q2	13C2
824	20F12Q8	BLANK	BLANK
825	20F12T8	BLANK	BLANK
826	150	20F12Q8	34
827	Q11	150	59
828	150	BLANK	85
829	120T2	BLANK	85
830	118Q2	120T2	BLANK

Code	Insert combination on shell		
	Cavity A	Cavity B	Cavity C
831	120T2	120T2	BLANK
832	Q11	121	100
833	150	150	17F12Q2
834	110R	150	17F12Q2
835	121	121	11Q2
838	Q11	BLANK	68Q2
839	60A	BLANK	34
840	150	110	11Q2
841	150	110	34
842	71C1	118Q2	12F5C2
843	110	110	BLANK
844	150	121	62F12
845	150	20F12Q8	13C2
846	C4	150	62F12
847	C4	150	11Q2
848	24	150	6Q6
849	150	150	10
850	150	110	13C2
851	36F36	150	85

Code	Insert combination on shell		
	Cavity A	Cavity B	Cavity C
852	150	121	11Q2
853	118Q2	150	11Q2
854	20F12Q8	118Q2	59
855	20F12Q8	Q11	100
856	BLANK	110	13C2
857	BLANK	36F36	BLANK
858	118Q2	118Q2	11Q2
859	150	36F36	13C2
860	150	118Q2	11Q2
861	118Q2	118Q2	59
862	150	118Q2	62Q2
863	Q11	Q11	17F12Q2
864	150	Q11	46Q2
865	118Q2	150	13C2
866	121	110	13C2
867	C4	C2	BLANK
868	150	118Q2	24T4

Insert Combination Code
FOR SHELL SIZE 3

NSX SERIES

Code	Insert combination on shell					
	Cavity A	Cavity B	Cavity C	Cavity D	Cavity E	Cavity F
301	150	150	13C2	150	150	13C2
302	150	150	100	150	150	13C2
303	150	150	13C2	150	150	100
304	150	150	100	150	150	100
305	150	150	BLANK	150	150	BLANK
306	150	71C1	13C2	150	71C1	13C2
307	71C1	71C1	13C2	71C1	71C1	13C2
308	C2	C2	13C2	C2	150	100
309	150	150	13C2	150	71C1	100
310	C4	C4	13C2	BLANK	150	100
311	150	150	85	150	150	85
312	BLANK	BLANK	13C2	BLANK	BLANK	13C2
313	BLANK	BLANK	13C2	BLANK	BLANK	100
314	BLANK	BLANK	13C2	BLANK	150	100
315	150	150	13C2	150	150	BLANK
316	24	BLANK	13C2	150	150	BLANK
317	120T2	150	34	120T2	150	34
320	150	60A	100	150	60A	100
321	150	150	100	150	BLANK	BLANK
322	150	150	100	150	150	34
323	150	150	100	71C1	71C1	100
324	150	150	100	C2	BLANK	BLANK
325	150	150	13C2	C2	C2	13C2
326	150	71C1	100	150	150	100
327	150	71C1	100	150	150	13C2
328	C2	C2	13C2	150	150	13C2
329	C2	C2	13C2	C4	150	100
330	C4	C4	13C2	BLANK	BLANK	BLANK
331	71C1	150	100	150	150	100
332	C4	C4	13C2	C4	C4	85
333	71C1	71C1	100	71C1	71C1	100
334	71C1	71C1	BLANK	71C1	71C1	BLANK
335	71C1	C4	100	71C1	C4	100
336	BLANK	150	13C2	BLANK	150	13C2
337	BLANK	BLANK	100	BLANK	BLANK	13C2
338	C2	150	100	150	150	100
339	C2	C2	100	C2	C2	100
340	C2	C2	13C2	C2	C2	13C2
341	C4	C4	100	C4	C4	100
342	C4	C4	13C2	C4	C4	13C2

NSX T CAS connectors (insert code combination 310) are installed on equipment for use on T CAS (Traffic Collision Avoidance Systems)
C4 insert uses size 1 RF coaxial contacts (see pages 4-42 to 4-43)

Insert Combination Code
FOR SHELL SIZE 3

Code	Insert combination on shell					
	Cavity A	Cavity B	Cavity C	Cavity D	Cavity E	Cavity F
343	BLANK	150	100	150	150	13C2
344	24	150	13C2	24	150	13C2
345	60A	24	BLANK	60A	24	BLANK
346	150	24	100	150	150	34
348	C4	120T2	100	150	150	13C2
350	150	120T2	100	150	120T2	59
351	150	150	34	150	150	34
352	24	24	100	24	24	34
353	150	150	59	150	150	59
354	150	150	34	150	24	100
355	C4	150	13C2	BLANK	150	13C2
356	150	150	100	60A	60A	100
357	C4	C4	13C2	150	150	100
358	C4	C4	13C2	121	150	100
359	121	121	13C2	121	121	13C2
360	150	150	6T6	24	24	13C2
361	150	BLANK	13C2	150	150	BLANK
362	24	24	34	150	121	34
363	150	150	59	24	60A	59
364	60A	24	59	150	150	59
365	24	60A	100	24	60A	100
366	150	150	84	150	150	100
367	150	150	59	120T2	120T2	100
368	150	150	59	150	150	34
369	150	150	59	150	150	100
370	60A	60A	100	60A	60A	100
371	C4	C4	13C2	C2	150	100
372	150	150	BLANK	121	BLANK	13C2
373	150	150	13C2	120T2	120T2	100
374	150	150	68Q2	150	150	68Q2
375	150	150	100	150	150	68Q2
376	150	150	68Q2	150	150	BLANK
377	120T2	150	13C2	120T2	150	100
378	Q11	150	13C2	150	150	13C2
379	60A	150	34	150	150	34
380	C4	120T2	11Q2	C4	120T2	13C2
381	C4	120T2	11Q2	C4	120T2	11Q2
382	150	150	11Q2	150	150	11Q2
383	150	150	BLANK	Q11	150	85
384	Q11	150	85	150	150	BLANK

Insert Combination Code

FOR SHELL SIZE 3

Code	Insert combination on shell					
	Cavity A	Cavity B	Cavity C	Cavity D	Cavity E	Cavity F
387	Q11	Q11	62Q2	Q11	Q11	62Q2
388	Q11	Q11	Q6	Q11	Q11	62Q2
389	Q11	150	11Q2	150	150	68Q2
390	150	150	11Q2	BLANK	BLANK	BLANK
393	BLANK	BLANK	13C2	150	BLANK	BLANK
394	BLANK	BLANK	13C2	150	BLANK	13C2
395	Q11	Q11	100	Q11	Q11	100
396	BLANK	BLANK	BLANK	BLANK	BLANK	BLANK
397	Q11	Q11	11Q2	Q11	150	11Q2
398	150	120T2	85	150	120T2	85
399	121	BLANK	6T6	60A	BLANK	13C2
601	60A	60A	13C2	60A	60A	13C2
602	Q11	150	11Q2	150	150	11Q2
603	24	BLANK	13C2	BLANK	BLANK	13C2
604	150	150	BLANK	150	150	100
605	150	Q11	11Q2	150	Q11	68Q2
607	24	24	13C2	24	24	100
608	24	24	13C2	24	24	68Q2
609	150	150	34	150	120T2	13C2
610	150	150	34	150	Q11	13C2
611	BLANK	150	13C2	BLANK	150	100
613	Q11	150	68Q2	150	150	13C2
614	150	150	100	BLANK	BLANK	BLANK
615	150	150	100	150	150	59
616	150	150	13C2	60A	120T2	34
617	60A	120T2	13C2	60A	120T2	13C2
618	150	150	Q6	150	150	Q6
619	Q11	Q11	11Q2	150	150	100
620	24	24	34	24	BLANK	34
621	150	150	34	150	60A	34
622	120T2	150	100	120T2	150	100
623	C4	C4	34	C4	C4	BLANK
624	150	150	13C2	60A	60A	34
626	C4	C4	13C2	120T2	150	100
627	C4	120T2	BLANK	C4	120T2	11Q2

NSX SERIES

Insert Combination Code

FOR SHELL SIZE 3

Code	Insert combination on shell					
	Cavity A	Cavity B	Cavity C	Cavity D	Cavity E	Cavity F
629	C4	120T2	17F12Q2	C4	120T2	11Q2
630	C4	C4	BLANK	C4	C4	34
631	BLANK	150	13C2	BLANK	Q11	BLANK
632	BLANK	150	13C2	150	150	68Q2
633	150	150	100	Q11	Q11	11Q2
634	150	120T2	34	150	120T2	34
635	Q11	121	11Q2	Q11	121	11Q2
636	150	150	11Q2	150	150	100
637	BLANK	150	11Q2	150	150	68Q2
638	Q11	150	62Q2	Q11	150	62Q2
639	Q11	121	13C2	Q11	121	13C2
641	150	150	BLANK	150	150	13C2
642	121	60A	59	121	60A	13C2
643	Q11	Q11	Q6	Q11	Q11	Q6
644	150	Q11	34	Q11	Q11	34
645	150	150	11Q2	150	150	BLANK
646	150	BLANK	13C2	150	BLANK	BLANK
647	C4	120T2	17F12Q2	C4	120T2	13C2
648	BLANK	BLANK	17F12Q2	BLANK	BLANK	BLANK
649	150	150	15T6Q2	150	150	15T6Q2
651	Q11	118Q2	59	Q11	118Q2	59
652	121	121	34	121	121	34
653	C4	C4	13C2	C4	150	100
654	C4	150	62F12	C4	150	11Q2
655	36F36	150	11Q2	150	150	68Q2
656	71C1	71C1	85	71C1	71C1	85
657	Q11	Q11	34	120T2	150	13C2
660	C4	BLANK	BLANK	150	BLANK	13C2
661	Q11	Q11	85	Q11	Q11	85
662	BLANK	BLANK	13C2	150	150	100
664	Q11	Q11	100	118Q2	Q11	34

Modification Code

NSX SERIES

Code	Receptacle shell			Plug shell		
00		<p>Ø 3.76 Ø (.148) All holes</p>		<p>Ø 3.76 Ø (.148) All holes</p>		
01		<p>Shell size 1: Q^y = 4 6-32 UNC & Q^y = 6 4-40 UNC</p> <p>Shell size 2: Q^y = 6 6-32 UNC</p> <p>Shell size 3: Q^y = 10 6-32 UNC</p>		<p>6-32 UNC</p> <p>Shell size 1: Q^y = 4 Shell size 2: Q^y = 4 Shell size 3: Q^y = 8</p> <p>Size 1 plug is without threaded inserts</p>		
03		<p>Shell size 1: Q^y = 6 4-40 UNC 2B & Q^y = 3 holes Ø 3.05 (.120)</p> <p>Shell size 2: Q^y = 6 & Q^y = 4 holes Ø 3.76 (.148)</p> <p>Shell size 3: Q^y = 10 & Q^y = 4 holes Ø 3.76 (.148)</p>		<p>Shell size 1 plug is without threaded inserts</p> <p>Shell size 1: Q^y = 4 4-40 UNC</p> <p>Shell size 2: Q^y = 4 4-40 UNC & Q^y = 6 holes Ø 3.76 (.148)</p> <p>Shell size 3: Q^y = 8 & Q^y = 6 holes Ø 3.76 (.148)</p>		
08		<p>4-40 UNC All holes</p> <p>Shell sizes 2 and 3 only</p>		<p>4-40 UNC All holes</p> <p>Shell sizes 2 and 3 only</p>		
09		<p>6-32 UNC All holes</p> <p>Shell sizes 2 and 3 only</p>		<p>6-32 UNC All holes</p> <p>Shell sizes 2 and 3 only</p>		
10		<p>M3 x 0.50 All holes</p> <p>Shell size 1 receptacle is without threaded inserts</p>		<p>M3 x 0.50 All holes</p> <p>Shell size 1 plug is without threaded inserts</p>		

Modification Code

Code	Receptacle shell	Plug shell
11	<p>M3 x 0.50</p> <p>Shell size 1: Q^y = 4 Shell size 2: Q^y = 6 Shell size 3: Q^y = 10</p> <p>Size 1 receptacle is without threaded inserts</p>	<p>M3 x 0.50</p> <p>Shell size 1: Q^y = 4 Shell size 2: Q^y = 4 Shell size 3: Q^y = 8</p> <p>Shell size 1 plug is without threaded inserts</p>
12	<p>4-40 UNC 6 holes (4 close to the bosses and 2 at the polarization system level)</p> <p>Available for shell size 2 only</p>	<p>4-40 UNC 6 holes (4 in to the corner and 2 at the polarization system level)</p> <p>Available for shell size 2 only</p>
23	<p>Shell size 1: Q^y = 4 floating eyelets Ø 3.1 (.122) Shell size 2: Q^y = 6 Ø 3.76 (.148) + 4 floating eyelets Shell size 3: Q^y = 10 Ø 3.76 (.148) + 4 floating eyelets</p>	<p>Shell size 1: Ø 3.1 (.122) Shell size 2 and 3: Ø 3.6 (.141)</p> <p>4 floating eyelets</p>

Polarization Code

POSITION OF POLARIZATION KEYS AND POSTS

Connectors are shown front side, with "RADIALL" upward

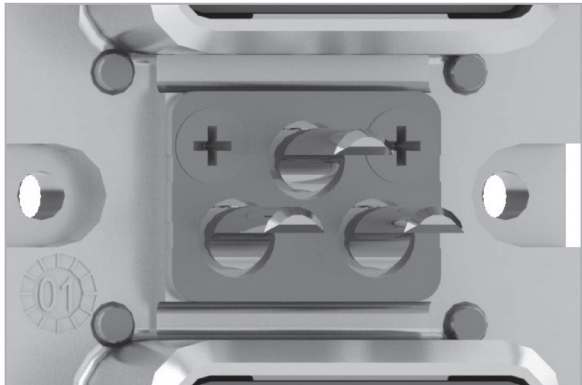

POSTS

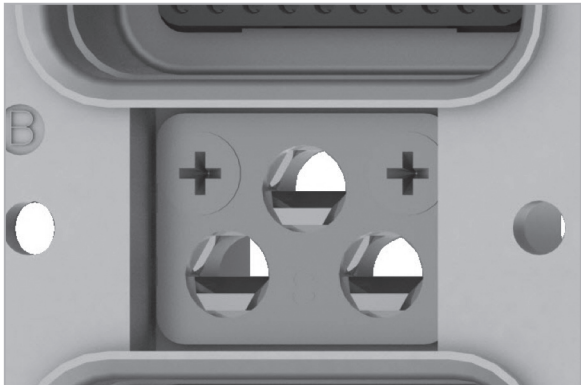

KEYS

POSITION CODING

Dark area represents the polarizing post
Clear portion represents the key hole



1



2



3



4



5



6

NSX SERIES

NSX SERIES

Polarization Code Table

Code number	Receptacle shell			Plug shell		
	Left key	Center key	Right key	Left post	Center post	Right post
00	-	-	-	-	-	-
01	4	4	4	1	1	1
02	4	4	3	2	1	1
03	4	4	2	3	1	1
04	4	4	1	4	1	1
05	4	4	6	5	1	1
06	4	4	5	6	1	1
07	5	4	4	1	1	6
08	5	4	3	2	1	6
09	5	4	2	3	1	6
10	5	4	1	4	1	6
11	5	4	6	5	1	6
12	5	4	5	6	1	6
13	6	4	4	1	1	5
14	6	4	3	2	1	5
15	6	4	2	3	1	5
16	6	4	1	4	1	5
17	6	4	6	6	1	5
18	6	4	5	5	1	5
19	1	4	4	1	1	4
20	1	4	3	2	1	4
21	1	4	2	3	1	4
22	1	4	1	4	1	4
23	1	4	6	5	1	4
24	1	4	5	6	1	4
25	2	4	4	1	1	3
26	2	4	3	2	1	3
27	2	4	2	3	1	3
28	2	4	1	4	1	3
29	2	4	6	5	1	3
30	2	4	5	6	1	3
31	3	4	4	1	1	2
32	3	4	3	2	1	2
33	3	4	2	3	1	2
34	3	4	1	4	1	2
35	3	4	6	6	1	2
36	3	4	5	5	1	2
37	4	3	4	1	2	1
38	4	3	3	2	2	1
39	4	3	2	3	2	1
40	4	3	1	4	2	1
41	4	3	6	5	2	1
42	4	3	5	6	2	1
43	5	3	4	1	2	6
44	5	3	3	2	2	6
45	5	3	2	3	2	6
46	5	3	1	4	2	6
47	5	3	6	5	2	6
48	5	3	5	6	2	6
49	6	3	4	1	2	5

Code number	Receptacle shell			Plug shell		
	Left key	Center key	Right key	Left post	Center post	Right post
50	6	3	3	2	2	5
51	6	3	2	3	2	5
52	6	3	1	4	2	5
53	6	3	6	5	2	5
54	6	3	5	6	2	5
55	1	3	4	1	2	4
56	1	3	3	2	2	4
57	1	3	2	3	2	4
58	1	3	1	4	2	4
59	1	3	6	5	2	4
60	1	3	5	6	2	4
61	2	3	4	1	2	3
62	2	3	3	2	2	3
63	2	3	2	3	2	3
64	2	3	1	4	2	3
65	2	3	6	5	2	3
66	2	3	5	6	2	3
67	3	3	4	1	2	2
68	3	3	3	2	2	2
69	3	3	2	3	2	2
70	3	3	1	4	2	2
71	3	3	6	5	2	2
72	3	3	5	6	2	2
73	4	2	4	1	3	1
74	4	2	3	2	3	1
75	4	2	2	3	3	1
76	4	2	1	4	3	1
77	4	2	6	5	3	1
78	4	2	5	6	3	1
79	5	2	4	1	3	6
80	5	2	3	2	3	6
81	5	2	2	3	3	6
82	5	2	1	4	3	6
83	5	2	6	5	3	6
84	5	2	5	6	3	6
85	6	2	4	1	3	5
86	6	2	3	2	3	5
87	6	2	2	3	3	5
88	6	2	1	4	3	5
89	6	2	6	5	3	5
90	6	2	5	6	3	5
91	1	2	4	1	3	4
92	1	2	3	2	3	4
93	1	2	2	3	3	4
94	1	2	1	4	3	4
95	1	2	6	5	3	4
96	1	2	5	6	3	4
97	2	2	4	1	3	3
98	2	2	3	2	3	3
99	2	2	2	3	3	3

Polarization Code Table









Code number	Receptacle shell			Plug shell		
	Left key	Center key	Right key	Left post	Center post	Right post
100	2	2	1	4	3	3
101	2	2	6	5	3	3
102	2	2	5	6	3	3
103	3	2	4	1	3	2
104	3	2	3	2	3	2
105	3	2	2	3	3	2
106	3	2	1	4	3	2
107	3	2	6	5	3	2
108	3	2	5	6	3	2
109	4	1	4	1	4	1
110	4	1	3	2	4	1
111	4	1	2	3	4	1
112	4	1	1	4	4	1
113	4	1	6	5	4	1
114	4	1	5	6	4	1
115	5	1	4	1	4	6
116	5	1	3	2	4	6
117	5	1	2	3	4	6
118	5	1	1	4	4	6
119	5	1	6	5	4	6
120	5	1	5	6	4	6
121	6	1	4	1	4	5
122	6	1	3	2	4	5
123	6	1	2	3	4	5
124	6	1	1	4	4	5
125	6	1	6	5	4	5
126	6	1	5	6	4	5
127	1	1	4	1	4	4
128	1	1	3	2	4	4
129	1	1	2	3	4	4
130	1	1	1	4	4	4
131	1	1	6	5	4	4
132	1	1	5	6	4	4
133	2	1	4	1	4	3
134	2	1	3	2	4	3
135	2	1	2	3	4	3
136	2	1	1	4	4	3
137	2	1	6	5	4	3
138	2	1	5	6	4	3
139	3	1	4	1	4	2
140	3	1	3	2	4	2
141	3	1	2	3	4	2
142	3	1	1	4	4	2
143	3	1	6	5	4	2
144	3	1	5	6	4	2
145	4	6	4	1	5	1
146	4	6	3	2	5	1
147	4	6	2	3	5	1
148	4	6	1	4	5	1
149	4	6	6	5	5	1
150	4	6	5	6	5	1
151	5	6	4	1	5	6
152	5	6	3	2	5	6
153	5	6	2	3	5	6
154	5	6	1	4	5	6
155	5	6	6	5	5	6
156	5	6	5	6	5	6
157	6	6	4	1	5	5
158	6	6	3	2	5	5

Code number	Receptacle shell			Plug shell		
	Left key	Center key	Right key	Left post	Center post	Right post
159	6	6	2	3	5	5
160	6	6	1	4	5	5
161	6	6	6	5	5	5
162	6	6	5	6	5	5
163	1	6	4	1	5	4
164	1	6	3	2	5	4
165	1	6	2	3	5	4
166	1	6	1	4	5	4
167	1	6	6	5	5	4
168	1	6	5	6	5	4
169	2	6	4	1	5	3
170	2	6	3	2	5	3
171	2	6	2	3	5	3
172	2	6	1	4	5	3
173	2	6	6	5	5	3
174	2	6	5	6	5	3
175	3	6	4	1	5	2
176	3	6	3	2	5	2
177	3	6	2	3	5	2
178	3	6	1	4	5	2
179	3	6	6	5	5	2
180	3	6	5	6	5	2
181	4	5	4	1	6	1
182	4	5	3	2	6	1
183	4	5	2	3	6	1
184	4	5	1	4	6	1
185	4	5	6	5	6	1
186	4	5	5	6	6	1
187	5	5	4	1	6	6
188	5	5	3	2	6	6
189	5	5	2	3	6	6
190	5	5	1	4	6	6
191	5	5	6	5	6	6
192	5	5	5	6	6	6
193	6	5	4	1	6	5
194	6	5	3	2	6	5
195	6	5	2	3	6	5
196	6	5	1	4	6	5
197	6	5	6	5	6	5
198	6	5	5	6	6	5
199	1	5	4	1	6	4
200	1	5	3	2	6	4
201	1	5	2	3	6	4
202	1	5	1	4	6	4
203	1	5	6	5	6	4
204	1	5	5	6	6	4
205	2	5	4	1	6	3
206	2	5	3	2	6	3
207	2	5	2	3	6	3
208	2	5	1	4	6	3
209	2	5	6	5	6	3
210	2	5	5	6	6	3
211	3	5	4	1	6	2
212	3	5	3	2	6	2
213	3	5	2	3	6	2
214	3	5	1	4	6	2
215	3	5	6	5	6	2
216	3	5	5	6	6	2

NSX SERIES

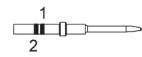

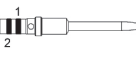
Contacts

SIGNAL, POWER AND GROUND CONTACTS CRIMP TERMINATION

Contact size		22	22 reduced crimp barrel	20	16	16 reduced crimp barrel
Ins.Ext Tool (metallic)	Radiall P/N	282885		282886	282546	
	Mil Spec P/N	M81969/1.01		M81969/1.02	M81969/1.03	
Ins.Ext Tool (plastic)	Radiall P/N	282522		282549029	282515	-
	Mil spec P/N	M81969/14.01		M81969/14.02	M81969/14.03	-
Positioner	Radiall P/N	282970		282971	282972	
	Mil spec P/N	M22520/2.23		M22520/2.08	M22520/1.02	
Crimping Tool	Radiall P/N	282281		282281	282291	
	Mil spec P/N	M22520/2.01		M22520/2.01	M22520/1.01	
Contact	Socket	620300  (1) Orange (2) Yellow	620301 	620310  (1) Orange (2) Red	620330  (1) Orange (2) Blue	620331 
	Pin	620200  (1) Orange (2) Green	620201 	620210  (1) Orange (2) Red	620230  (1) Orange (2) Blue	620231 
Wire	Selector	4-3-3	5-4	5-6-7	6-5-4	5-4-3-2
	Striping length ± .020 mm (inch)	3.5 (.138)		4 (.157)	6 (.236)	
	Wire outside diameter mm (inch)	1.4 (.055)	1.2 (.047)	1.8 (.071)	2.6 (.102)	1.97 (.077)
	Cross section (mm ²)	0.38-0.21-0.14	0.093-0.055	0.21-0.38-0.60	1.34-0.93-0.60	0.93-0.60-0.38-0.21
	Wire size (AWG)	22-24-26	28-30	20-22-24	16-18-20	18-20-22-24
Contact arrangement		See contact arrangement page 4-12 to 4-22				

Contacts

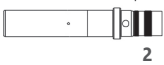
SIGNAL, POWER AND GROUND CONTACTS CRIMP TERMINATION

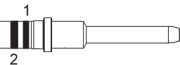
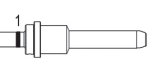
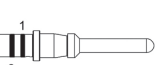

Contact size		12	12 reduced crimp barrel	12
Ins.Ext Tool (metallic)	Radiall P/N	282549004		-
	Mil spec P/N	M81969/28.02		M81969/19.02
Ins.Ext Tool (plastic)	Radiall P/N	282549004		-
	Mil spec P/N	M81969/14.04		-
Positioner	Radiall P/N	282972		282579
	Mil spec P/N	M22520/1.02		M22520/1.11
Crimping Tool	Radiall P/N	282291		
	Mil spec P/N	M22520/1.01		
Contact	Socket	<p>620340</p>  <p>(1) Orange (2) Yellow</p>	<p>620341</p>  <p>(1) Orange</p>	-
	Pin	<p>620240</p>  <p>(1) Orange (2) Yellow</p>	<p>620241</p>  <p>(1) Orange</p>	<p>619240</p>  <p>(front release rear removable contact)</p> <p>(1) Orange (2) Yellow</p>
Wire	Selector	8-7-6	2-3-4-5	8-7-6
	Striping length ± .020 mm (inch)	6 (.236)		
	Wire outside diameter mm (inch)	3.4 (.134)	2.4 (.094)	3.4 (.134)
	Cross section (mm ²)	3.18-1.91-1.34	0.93-0.60-0.38-0.21	3.18-1.91-1.34
	Wire size (AWG)	12-14-16	18-20-22-24	12-14-16
Contact arrangement		See contact arrangement page 4-12 to 4-22		

NOTE:

Radiall recommends plastic extraction tools for environmental cavities 22-20-16 and 12 (the metallic extraction tool leads to damage risk of triple silicon web)

Contacts

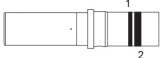
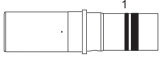
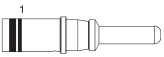
SIGNAL, POWER AND GROUND CONTACTS CRIMP TERMINATION

Contact size		8	8 grounded		5	
Ext Tool (metallic)	Radiall P/N	socket: 282549001 pin: 282549012	282549012	282540001	282548	
	Mil spec P/N	socket: M81969/28.03 pin: M81969/19.03	M81969/19.03	M81969/28.03	M81969/28.01	
Positioner	Radiall P/N	-	-	282588	282557	
	Mil spec P/N	M22520/23.09	M22520/23.09	-	-	
Die	Radiall P/N	-	-	-	-	
	Mil spec P/N	M22520/23.02	M22520/23.02	M22520/23.02	-	
Crimping Tool	Radiall P/N	-	-	-	282296	
	Mil spec P/N	M22520/23.01	M22520/23.01	M22520/23.01	-	
Contact	Socket	619370  (1) Orange (2) Brown	-	619371  (1) Orange (2) Black	616361	616366
	Pin	619270 {front release rear  (1) Orange (2) Brown	619271  {front release rear removable contact (1) Orange (2) Black	-	616261	616266
Wire	Selector	-	-	-	1-1	8-5
	Striping length ± .020 mm (inch)	11.5 (.453)	11.5 (.453)	-	8.0 (.315)	
	Wire outside diameter mm (inch)	5.7 (.224)	5.7 (.224)	-	3.4 (.134)	5.7 (.234)
	Cross section (mm ²)	9-5	9-5	-	3.18-1.91	9-5
	Wire size (AWG)	8-10	8-10	-	12-14	8-10
Contact arrangement		6P6	See contact arrangement page 4-12 to 4-22			

Contacts

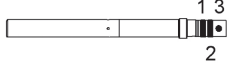
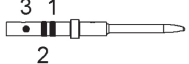
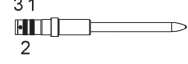

CHROMEL CONTACTS – CRIMP TERMINATION

Contact size		22	20
Ins.Ext Tool	Radiall P/N	282885	282886
	Mil spec P/N	M81969/1.01	M81969/1.02
Positioner	Radiall P/N	282970	282971
	Mil spec P/N	M22520/2.23	M22520/2.08
Crimping Tool	Radiall P/N	282281	
	Mil spec P/N	M22520/2.01	
Contact	Socket	620380 (1) Orange (2) Green (3) Yellow	620390  (1) Orange (2) Red (3) Yellow
	Pin	620280  (1) Orange (2) Green (3) Yellow	620290  (1) Orange (2) Red (3) Yellow
Wire	Selector	4-3-3	7-6-5
	Striping length ± .020 mm (inch)	3.5 (.138)	4 (.157)
	Wire outside diameter mm (inch)	1.4 (.055)	1.8 (.071)
	Cross section (mm ²)	0.38-0.21-0.14	0.60-0.38-0.21
	Wire size (AWG)	22-24-26	20-22-24
Contact arrangement		See contact arrangement page 4-12 to 4-22	

NSX SERIES

Contacts

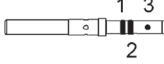
ALUMEL CONTACTS – CRIMP TERMINATION

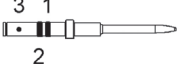
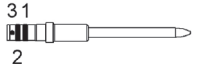
Contact size		22	20
Ins.Ext Tool	Radiall P/N	282885	282886
	Mil spec P/N	M81969/1.01	M81969/1.02
Positioner	Radiall P/N	282970	282971
	Mil spec P/N	M22520/2.23	M22520/2.08
Crimping Tool	Radiall P/N	282281	
	Mil spec P/N	M22520/2.01	
Contact	Socket	<p>620381</p>  <p>(1) Orange (2) Green (3) Black</p>	<p>620391</p>  <p>(1) Orange (2) Red (3) Black</p>
	Pin	<p>620281</p>  <p>(1) Orange (2) Green (3) Black</p>	<p>620291</p>  <p>(1) Orange (2) Red (3) Black</p>
Wire	Selector	4-3-3	7-6-5
	Striping length ± .020 mm (inch)	3.5 (.138)	4 (.157)
	Wire outside diameter mm (inch)	1.4 (.055)	1.8 (.071)
	Cross section (mm ²)	0.38-0.21-0.14	0.60-0.38-0.21
	Wire size (AWG)	22-24-26	20-22-24
Contact arrangement		See contact arrangement page 4-12 to 4-22	

Contacts

SIZE 1 COAXIAL CONTACTS

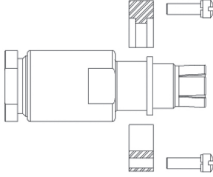
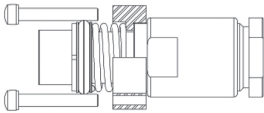
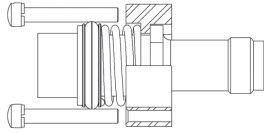
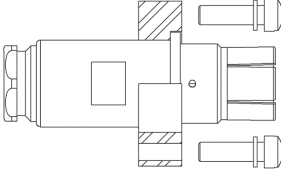
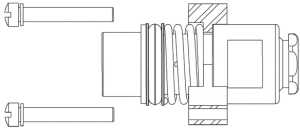
Wire	Type	Part number	Contact	Contact arrangements
RG 214 RG 393	Pin	620001		71C1-1C71-C2
	Socket	620101		
		620101001	Identical to 620101 without O-ring	
Not applicable TNC termination	Socket	620101003		71C1-1C71-C2
		620101004	Identical to 620101003 without O-ring	
RG 223 RG 142	Pin	620003		71C1-1C71-C2
	Socket	620103		

NSX SERIES

Contacts

SIZE 1 COAXIAL CONTACTS

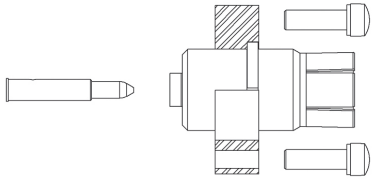
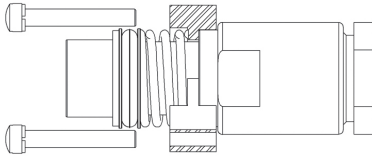
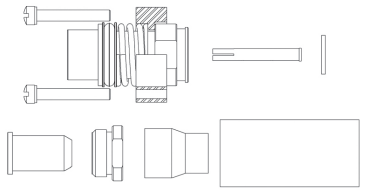
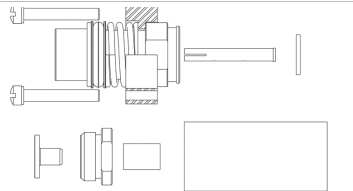
Wire	Type	Part number	Contact	Contact arrangements
RG 402 UT .141	Pin	620005		71C1-1C71-C2
NSA 935 358	Socket	620107		71C1-1C71-C2
		620107001	Identical to 620107 without O-ring	
ASNE 0406 WD and FILECA 1 703/94	Socket	620108		71C1-1C71-C2
		620108002	Identical to 620108 without O-ring	
RG 400 RG 142	Socket	620109		71C1-1C71-C2
		620109001	Identical to 620109 without O-ring	

Contacts

SIZE 1 COAXIAL CONTACTS

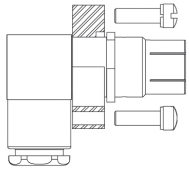
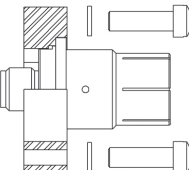
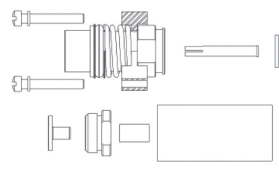
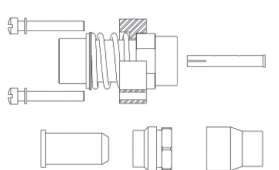
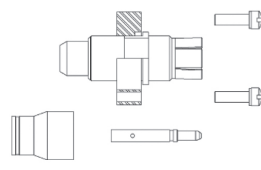
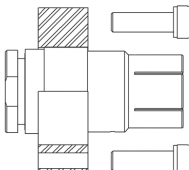
Wire	Type	Part number	Contact	Contact arrangements
RG 142	Pin	620011		71C1-1C71-C2
Not applicable SMA termination	Pin	620044		71C1-1C71-C2
ASNE0691WM	Socket	620101011		71C1-1C71-C2
ASNE0692WN	Socket	620101012		71C1-1C71-C2
ASNE0692WN	Pin	620001012		71C1-1C71-C2
RD316	Pin	620043001		71C1-1C71-C2



NSX SERIES

Contacts

DELIVERY CODE FOR T-GAS APPLICATION

Code	Connector details	Socket contacts for plug	Pin contacts for receptacle
No code	<p>Contacts: Size 1 RF coaxial contacts to be ordered separately.</p> <p>Inserts: For plug: - Mating side insert: thermoplastic. - Size 1 RF coax retention plate: stainless steel.</p> <p>For receptacle: - Aluminum alloy nickel plated.</p>	620117 620146	620049
N	Connector delivered with coaxial contacts	620116	620049

SIZE 1 RF COAXIAL CONTACTS FOR NSX T-GAS CONNECTOR

Cable	Contact type	Part number	Contact
TNC TERMINATION	Socket	620116	
TNC TERMINATION	Pin	620017	
ASNE 0406WD ECS 311 201	Socket	620117	
RG 225 RG 393	Socket	620119100	
ECS 310801	Socket	620119102	
RG 142 RG 400 TIMES AA6343 ECS 3C142B ASNE 0293XF	Socket	620146	

Contacts

SIZE 1 RF COAXIAL CONTACTS FOR NSX T-CAS CONNECTOR

Cable	Contact type	Part number	Contact
RG 142	Pin	620046	
UT 141	Pin	620047	
UT .085	Pin	620047010	
SMA TERMINATION	Pin	620049	
ASNE0692WN- ASNE0406WD	Pin	620019105	
ASNE0692WN	Socket	620119105	

NSX SERIES

Contacts



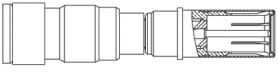
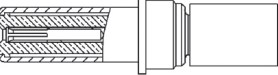
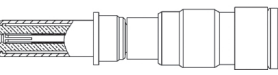



SIZE 8 COAXIAL CONTACTS

Wire	Type	Part number	Contact	For insert	Ins/Ext Tool
RG142 RG400 RG412 RG223 RG55U ASNE0293XF	Socket	619051		For all size 8 cavities	282549001 (M81969/28.03)
	Socket	619051001 environmental			
	Pin	619151			
	Pin	619151001 environmental			

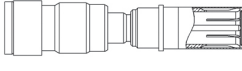
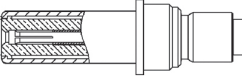
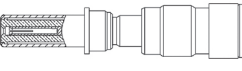
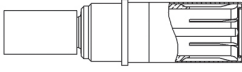
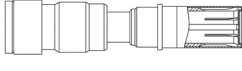
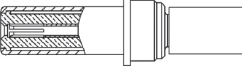

Contacts

SIZE 8 COAXIAL CONTACTS

Wire	Type	Part number	Contact	For insert ⁽¹⁾	Ins/Ext Tool	
RG316-KX22 -RG179 ASNE0639XY	Socket	619054		for all size 8 cavities	282549001 (M81969/28.03)	
		619054001 environmental				
	Pin	619154			-	
		619154001 environmental				
Gore GSC-03-8174 8-00	Socket	619053			for all size 8 cavities	282549001 (M81969/28.03)
		619053001 environmental				
	Pin	619153				-
		619153001 environmental				
RG180 RG195	Socket	619052		for all size 8 cavities	282549001 (M81969/28.03)	
		619052001 environmental				
	Pin	619152			-	
		619152001 environmental				





NSX SERIES

NOTE:

(1) Except for inserts 6T6 and 10T10

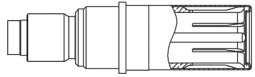
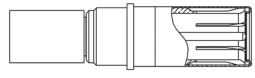
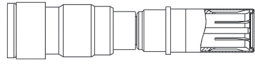
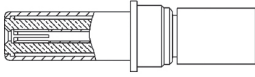
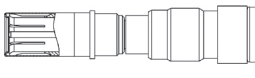
Contacts

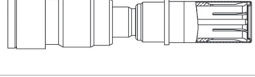
SIZE 8 COAXIAL CONTACTS

Wire	Type	Part number	Contact	For insert ⁽¹⁾	Ins/Ext Tool
ASNE0690WL	Socket	619054002		for all size 8 cavities	282549001 (M81969/28.03)
	Socket	619050			-
		619050001 environmental			-
RG58 RG141	Pin	619150			-
		619150001 environmental			-
	Socket	619055			-
		619055001 environmental			-
RG178 KX21 ASNE0633WG	Pin	619155			-
		619155001 environmental			

NOTE:

(1) Except for inserts 6T6 and 10T10.

Contacts

SIZE 8 COAXIAL CONTACTS

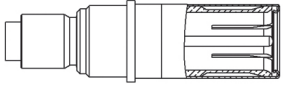
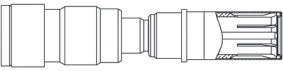
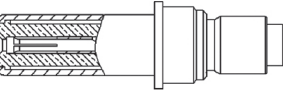
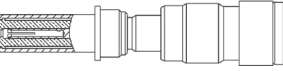
Wire	Type	Part number	Contact	For insert ⁽¹⁾	Ins/Ext Tool
RG316	Socket	619056		For all size 8 cavities	-
		619056001 environmental			
	Pin	619156			-
		619156001 environmental			-







NSX SERIES

NOTE:
 (1) Except for inserts 6T6 and 10T10

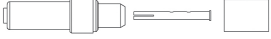
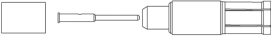
Contacts





SIZE 5 COAXIAL CONTACTS

Wire	Type	Part number	Contact	For insert	Ins/Ext Tool
RG 58 RG 141	Pin	620120*		for all size 5 cavities	282946 (M81969/28.01)
	Socket	620020*			
RG 142 RG 223 RG 400	Pin	620121*			
	Socket	620021*			
ASNE0639XY RG 179 RG 316 KX 22	Pin	620122*			
	Socket	620022*			282946 (M81969/28.01)

*Add 001 to these P/N to order for environmental contacts.

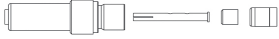
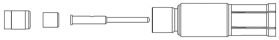
Contacts

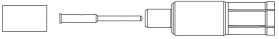
SIZE 5 COAXIAL CONTACTS







Wire	Type	Part number	Contact	For insert	Ins/Ext Tool
ASNE 0633WG RG 178 KX 21	Pin	620123*		for all size 5 cavities	282946 (M81969/28.01)
	Socket	620023*			
RG 180 RG 195	Pin	620124*			
	Socket	620024*			
RD 316	Pin	620129*			
	Socket	620029*			

*Add 001 to these P/N to order for environmental contacts

NSX SERIES

Contacts

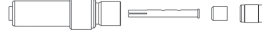



SIZE 5 COAXIAL CONTACTS

Wire	Type	Part number	Contact	For insert	Ins/Ext Tool
ADAMS-RUSSEL FC 11Z (per S280W503-1)	Pin	620182001		for all size 5 cavities	282946 (M81969/28.01)
	Socket	620082001			
ADAMS-RUSSEL FC 14Z (per S280W503-2)	Pin	620183001			
	Socket	620083001			
SMA Termination	Pin	620134			
ASNE0690WL	Pin	620184			282946 (M81969/28.01)
ASNE0690WL	Socket	620084		282946 (M81969/28.01)	

Contacts

NSX SERIES

SIZE 16 COAXIAL CONTACTS

Wire	Type	Part number	Contact	For insert	Ins/Ext Tool
KX22 RG 316 RG 179 ASNE0639XY ASNE0632WK ASNE0752WS	Pin	618150		for all size 16 cavities	282892
	Socket	618050			
RG 178 KX 21 ASNE0633WG	Pin	618154			282892
	Socket	618054			

SIZE 5 CONCENTRIC TWINAX CONTACTS

Wire	Type	Part number	For insert	Ins/Ext Tool
MIL C 17/17600002	Pin	616195001 ⁽¹⁾	for all size 5 cavities	282946 (M81969/28.01)
	Socket	616095001 ⁽²⁾		

(1) 616195001 contact environmental version is 616195009

(2) 616095001 contact environmental version is 616095009

SIZE 10 CONCENTRIC TWINAX CONTACTS

Wire	Type	Part number	For insert	Ins/Ext Tool
EN 3375-006 ASNE 0290XM	Pin	620167001	15T6Q2	(M81969/14-05)
	Socket	620067001		

Contacts

SIZE 8 CONCENTRIC TWINAX CONTACTS

Wire	Type	Part number	Contact	For insert	Ins/Ext Tool	
Tensolite (S280W502-1)	Pin	619165		for all size 8 cavities	282549001 (M81969/28.03)	
	Socket	619065				
	Pin	619166 ⁽¹⁾ FR/RR			282549001 (M81969/28.03) for ins. 282549012 (M81969/28.03) for ext.	
MIL C 17/17600002	Pin	619169001			for all size 8 cavities	282549001 (M81969/28.03)
	Socket	619069001				
		619069002 environmental				

NOTE:

(1) FR/RR contacts are compatible with 6T6 and 10T10 inserts.

Contacts

SIZE 8 QUADRAX CONTACTS

Wire	Type	Part number (non environmental)	Part number (environmental)	Ins/Ext Tool
ABS1503KD24 (110 Ω)	Pin	620175010	620175011	282549001 (M81969/28.03 or M81969/14.06)
	Socket	620075010	620075011	
THERMAX 956S-4T200 GORE RCN8422 (110 Ω)	Pin	620179002	620179001	
	Socket	620079002	620079001	
TENSOLITE NF24Q100 (100 Ω)	Pin	620175050	620175051	
	Socket	620075050	620075051	
TENSOLITE NF26Q100 JSFY 18	Pin	620175021	620175020	
	Socket	620075021	620075020	

NSX SERIES

Fiber Optic Contacts and Accessories

LUXCIS® CONTACTS

The LuxCis® product range is a proven, flexible and always expanding fiber optic interconnect solution offering high speed communication in aerospace and other harsh environments.

OPTICAL PERFORMANCES

	MultiMode (PC) 850 / 1300 nm	SingleMode (UPC) 1310 / 1550 nm
Insertion Loss (IL) Mean (IEC 61300-3-4 Method B)	0.1 dB	0.15 dB
Return Loss (RL) (IEC 61300-3-6)	> 20 dB	> 50 dB

MECHANICAL AND ENVIRONMENTAL CHARACTERISTICS

	Standard	Performances
Thermal cycling	SAE AS 13441 method 1003.1	-55°C/+125°C (cable dependant)
Temperature endurance	TIA/EIA 455-4	1000 h @ 125°C (cable dependant)
Vibration	TIA/EIA 455-11	16.4 Grms
Shocks	TIA/EIA 455-14	50 G, 11 ms
Durability	TIA / EIA 364-09	500 cycles
Maintenance ageing	SAE AS 13441 method 2002.1	10 cycles
Cable retention Cable retention 1.8 mm diameter 900 µm diameter	SAE AS 13441 method 2009.1	68 N 7 N
Humidity	TIA EIA 455-5	10 cycles / 24 h 90% RH -25°C / +65°C

LUXCIS® CONTACTS PART NUMBERING SYSTEM



F725 : LuxCis® series

Ferrule type

- 00**: PC ferrule for SingleMode fiber
- 03**: PC ferrule for 50/125 or 62,5/125 um MultiMode fiber
- 04**: PC ferrule for 100/40 um MultiMode fiber
- 05**: PC ferrule for 200/230 um MultiMode fiber
- 50**: APC ferrule for SingleMode fiber

Cable type and diameter

- 118**: 900 µm cable
- 318**: 1.2 mm cable with strengthening members, tight structure
- 419**: 1.6 to 2.2 mm cable, loose structure
- 519**: 1.6 to 2.2 mm cable, tight structure

NOTE:

Radiall can support you with your cable and harness assemblies.
Please contact your sales representative.

MIL-PRF-29504 Contacts

MIL-PRF-29504 fiber optic termini were developed several decades ago and are described several MIL standard documents. They fit into standard electrical cavities and do not require specific inserts. However, standard electrical connectors are not optimized for optical connections with small core fibers and MIL-PRF-29504 fiber optic termini show lower optical performances than more recent designs, such as the LuxCis®. MIL-PRF-29504 fiber optic termini can replace MIL-PRF-29504/6 pin and MIL-PRF-29504/7 socket termini.

PERFORMANCES

Insertion Loss (IL)	0.8 dB typical
Durability	Up to 500 mating cycles
Thermal cycling	-65°C / +125°C (cable dependent)

MIL-PRF-29504 TYPE CONTACTS PART NUMBERING SYSTEM

Contact size	Pin contact part number	Socket contact part number	Fiber diameter (µm)	Cable diameter (mm)	Ferule material	Insertion / Extraction tool
16	F724 004 000	F724 104 000	125	1.5	Ceramic	282515
16	F724 012 000	F724 111 000	125	1.8	Ceramic	
16	F724 010 000	F724 109 000	125	2	Ceramic	
16	F724 001 000	F724 101 000	140	1.5	Ceramic	
16	F724 040 000	F724 140 000	230	2	Metallic	
12	F724 204 000	F724 304 000	125	1.5	Ceramic	282549004
12	F724 242 000	F724 342 000	125	1.8	Ceramic	
12	F724 203 000	F724 303 000	140	1.5	Ceramic	



NOTE:

Radiall can support you with your cable and harness assemblies. Please contact your sales representative





Accessories

QUADRAX - LUXCIS® ADAPTER

Adapters for NSX connectors' cavities allow evolution of your existing connectors. Now, you can get high speed connection with a connector that used to be equipped with Quadrax contacts. Quadrax-LuxCis® adapters will turn a size 8 Quadrax cavity into a LuxCis® cavity.

This solution offers the following characteristics:

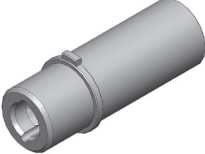
- Compliant with any ARINC 600 Quadrax cavity
- Compatible with ML and MT LuxCis® designs
- Available for multimode application
- Compatible with Quadrax insertion and extraction tool

	Part number	Description
	620946001	Pin quadrax adapter for LuxCis® contact in quadrax FR type cavity with sleeveholder
	620946002	Pin quadrax adapter for LuxCis® contact in quadrax RR type cavity with sleeveholder
	620946003	Socket quadrax adapter for LuxCis® contact in quadrax RR type cavity
	620946004	Sleeve holder for pin quadrax adapter

EN 4531-101 (ABS 1379) ADAPTER FOR QUADRAX SIZE 8 CAVITY

Quadrax-EN4531 adapter will help you turning a size 8 Quadrax cavity into a EN4531 fiber optic link with the following characteristics:

- Arinc 600 compliant
- EN4626 compliant
- Compatible with all EN4531 contacts

	Part number	Description
	620946005	Pin quadrax adapter for EN4531 contact
	620946006	Socket quadrax adapter for EN4531 contact

Contacts

NSX E/N/H/C – REAR REMOVABLE CONTACTS
REAR REMOVABLE PC TAIL CONTACTS

SIZE 22 SOCKET CONTACTS

Part number	Contact termination	Dimension X mm (inch)	C dia. mm (inch)	Ins/Ext Tool	Figure
620 305	YA	5.20 (.205) 4.20 (.165)	0.635 (.025)	282890	
620305005	ZA				

SIZE 22 PIN CONTACTS

Part number	Contact termination	Dimension X mm (inch)	C dia. mm (inch)	Ins/Ext Tool	Figure
620 202	Y	7.30 (.288) 6.30 (.250)	0.635 (.025)	282890	
620202005	Z				

REAR REMOVABLE WIRE WRAP CONTACTS

SIZE 22 SOCKET CONTACTS

Part number	Contact termination	Dimension X mm (inch)	Ins/Ext Tool	Figure
620302	K	7.70 (.303) 6.30 (.248)	282890	
620303	V	10.70 (.421) 9.30 (.366)		
620308	W	12.30 (.484) 13.70 (.540)		

How to Order

NSX F/G/K – CONNECTORS FOR FRONT REMOVABLE CONTACTS

Signal PC Tail contacts defined by termination code are delivered installed.
Coaxial twinax and quadrax contacts are ordered separately.

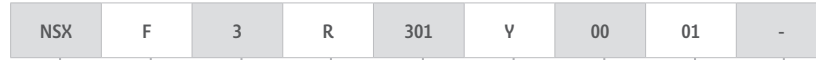

Series

Class

F: Receptacle connectors, non-environmental

Only size 22 insert cavities can be delivered in FR/FR PC tails or wire wrap contacts.
Other insert cavities, if equipped with signal and power contacts in sizes 20, 16 and 12, will be delivered in RR/RR crimp version.
Coaxial, twinax and quadrax contacts shall be ordered separately as RR/RR crimp contacts

G: Receptacle connectors, non-environmental

Every insert cavities will be delivered in FR/FR PC tail contacts only.
Size 1 contact will be delivered in RR/RR crimp version.
Coaxial, twinax and quadrax contacts shall be ordered separately as FR/FR PC tail contacts.

K: Receptacle connectors, non-environmental

Only combinations including inserts 100 and 150 are available in class K. Inserts 100 and 150 will be fully populated with size 22 harpooned contacts.
With class K, use PC tail contacts termination Y.
Other inserts will be populated as per class G.

Shell size

- 1: 3 small cavities
- 2: 3 large cavities
- 3: 6 large cavities

Shell style

- R: Alodine 1200 plated receptacle
- F: Nickel plated receptacle
- S: RoHS chromatisation plated receptacle

Insert combination code

See combination code pages 4-22 to 4-28 and contacts arrangement pages 4-12 to 4-21
T-cas application combination code : 310 (see page 4-25)

Contact termination

Without contacts

X: Without contacts

Wire wrap

- K:** Wire wrap contact, 1 level (1 = .272)
- V:** Wire wrap contact, 2 levels (1 = .390)
- W:** Wire wrap contact, 3 levels (1 = .524)
- L:** Wire wrap contact, 4 levels (1 = .660)

PC tail contacts

RoHs	Gold	Pre-tinned	Length (inch)
RA	YA	ZA	.150
R	Y	Z	.250
RB	YB	ZB	.375
RC	YC	ZC	.500

Modification code ⁽¹⁾

See pages 4-29 to 4-30

Polarization code

See pages 4-31 to 4-33
Without code: polarization hardware is delivered unassembled

Delivery code for T-CAS application

See page 4-42

NOTES:

- (1) Polarization code 00, the connector is delivered without polarizing hardware.
- Polarization code from 01 to 216, the connector is delivered with the polarization hardware assembled as defined by the code see page 4-31

Contacts

NSX F/G/K – FRONT REMOVABLE PC TAIL

SIZE 22 SOCKET CONTACTS

Part number	Contact termination	Dimension X mm (inch)	Ins/Ext Tool	Color band 1	Color band 2	Figure
620360	YA	4.60/3.80 [.181/.150]	282500	orange	green	
620360005	ZA					
620360500	RA					
620361	Y	7.20/6.40 [.283/.252]				
620361005	Z					
620361500	R					
620362	YB	10.30/9.50 [.406/.374]				
620362005	ZB					
620362500	RB					
620363	YC	13.60/12.80 [.535/.504]				
620363005	ZC					
620363500	RC					

SIZE 20 PIN CONTACTS

Part number	Contact termination	Dimension X mm (inch)	Ins/Ext Tool	Color band 1	Color band 2	E dia mm (inch)	Figure
620214018	YA	4.60/3.80 [.181/.150]	282503	orange	red	0.85/0.80 [.033/.031]	
620214019	ZA						
620214518	RA						
620214010	Y	7.20/6.40 [.283/.252]					
620214013	Z						
620214510	R						
620214003	YB	10.30/9.50 [.406/.374]					
620214008	ZB						
620214503	RB						
620214021	YC	13.60/12.80 [.535/.504]					
620214022	ZC						
620214521	RC						

SIZE 16 PIN CONTACTS

Part number	Contact termination	Dimension X mm (inch)	Ins/Ext Tool	Color band 1	Color band 2	E dia mm (inch)	Figure
620234018	YA	4.60/3.80 [.181/.150]	282504	orange	blue	1.32/1.22 [.052/.048]	
620234019	ZA						
620234518	RA						
620234004	Y	7.20/6.40 [.283/.252]					
620234017	Z						
620234504	R						
620234003	YB	10.30/9.50 [.406/.374]					
620234008	ZB						
620234503	RB						
620234021	YC	13.60/12.80 [.535/.504]					
620234022	ZC						
620234521	RC						

Contacts

NSX F/G/K – FRONT REMOVABLE PC TAIL

SIZE 12 PIN CONTACTS

Part number	Contact termination	Dimension X mm (inch)	Ins/Ext Tool	Color band 1	Color band 2	Figure
620244018	YA	4.60/3.80 (.181/.150)	282549005	orange	yellow	
620244019	ZA					
620244518	RA					
620244005	Y	7.20/6.40 (.283/.252)	282549005	orange	Yellow	
620244016	Z					
620244505	R					
620244003	YB	10.30/9.50 (.406/.374)	282549005	orange	yellow	
620244008	ZB					
620244503	RB					
620244021	YC	13.60/12.80 (.535/.504)	282549005	orange	yellow	
620244022	ZC					
620244521	RC					

SIZE 22 SOCKET FRONT REMOVABLE WIRE WRAP CONTACTS

Part number	Contact termination	Dimension X mm (inch)	Ins/Ext Tool	Color band 1	Color band 2	Figure
620350	K	6.9/0.4 (.256/.287)	282500	orange	green	
620351	V	9.9/0.4 (.374/.405)				
620352	W	13.3/0.4 (.508/.540)				
620353	L	16.8/0.4 (.645/.677)				

SIZE 16 PIN COAX CONTACTS

Part number	Contact termination	Dimension X mm (inch)	Ins/Ext Tool
618155001	YA	3.8/4.6 (.150/.181)	282504
618155002	Y	6.4/7.2 (.252/.283)	
618155011	YB	9.5/10.3 (.374/.405)	

Contacts

NSX F/G/K – FRONT REMOVABLE PC TAIL

SIZE 12 PIN COAX CONTACTS

Part number	Contact termination	Dimension X mm (inch)	Ins/Ext Tool
618149017	YA	3.8/4.6 (.150/.181)	282549005
618149016	Y	6.4/7.2 (.252/.283)	
618149018	YB	9.5/10.3 (.374/.405)	
618149012	YC	12.8/13.6 (.503/.535)	
618149013	ZC	12.8/14.1 (.503/.558)	

SIZE 8 PIN COAX CONTACTS

Part number	Contact termination	Dimension X mm (inch)	Ins/Ext Tool
619140009	YA	12.40/12.20 (.488/.480)	282549009
619140014	ZA		
619140509	RA		
619140010	Y	15.05/14.85 (.592/.584)	
619140013	Z		
619140510	R		
619140007	YB	18.15/17.95 (.715/.706)	
619140008	ZB		
619140507	RB		
619140011	YC	21.45/21.25 (.844/.836)	
619140012	ZC		
619140511	RC		

SIZE 5 PIN COAX CONTACTS

Part number	Contact termination	Dimension X mm (inch)	Ins/Ext Tool
620133009	YA	4.60/3.80 (.181/.150)	282549006
620133509	RA		
620133006	Y	7.20/6.40 (.283/.252)	
620133007	Z		
620133506	R		
620133003	YB	10.30/9.50 (.406/.374)	
620133001	ZB		
620133503	RB		
620133010	YC	13.60/12.80 (.535/.504)	
620133510	RC		

NSX SERIES

Contacts

NSX F/G/K – FRONT REMOVABLE PC TAIL

SIZE 8 PIN TRIAX PC TAIL FRONT RELEASE VERSION

Part number	Contact termination	Dimension X mm (inch)	Ins/Ext Tool
619162014	YA	4.60/3.80 (.181/.150)	282549009
619162015	ZA		
619162514	RA		
619162011	Y	7.20/6.40 (.283/.252)	
619162012	Z		
619162511	R		
619162016	YB	10.30/9.50 (.406/.374)	
619162017	ZB		
619162516	RB		
619162009	YC	13.60/12.80 (.535/.504)	
619162010	ZC		
619162509	RC		

SIZE 8 PIN QUADRAX CONTACTS

Part number	Contact termination	Dimension X mm (inch)	Ins/Ext Tool
620176009	YA	4.60/3.80 (.181/.150)	282549009
620176016	ZA		
620176509	RA		
620176008	Y	7.20/6.40 (.283/.252)	
620176010	Z		
620176508	R		
620176011	YB	10.30/9.50 (.406/.374)	
620176012	ZB		
620176511	RB		
620176013	YC	13.60/12.80 (.535/.504)	
620176014	ZC		
620176513	RC		

Dimensions

NON ENVIRONMENTAL SIZE 1 PLUG SHELL DIMENSIONS

NSX SERIES

FRONT VIEW

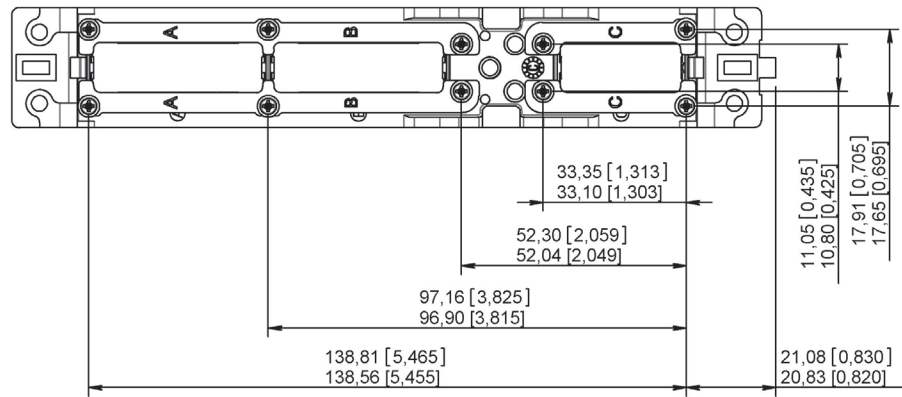

SIDE VIEW

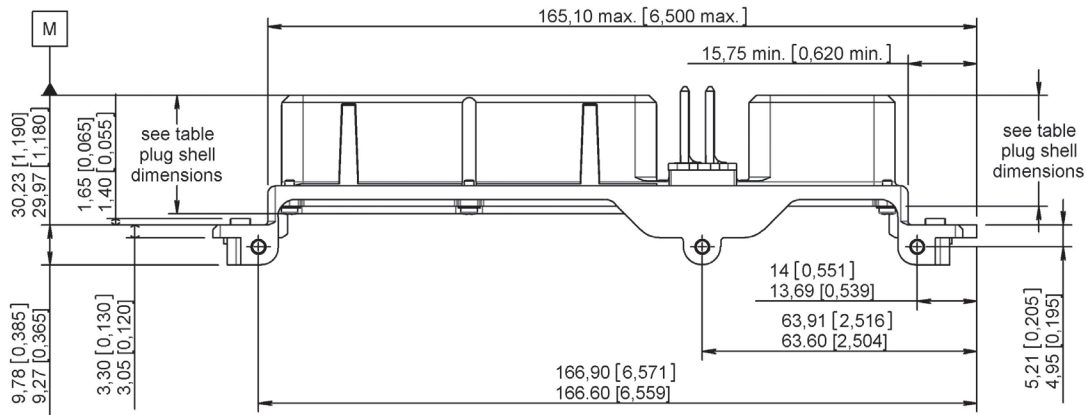

REAR VIEW

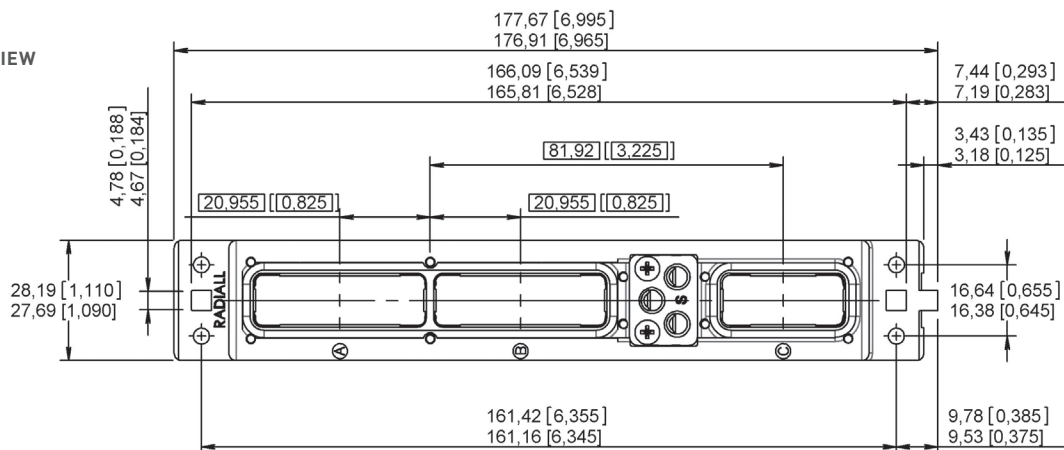

Dimensions

NON ENVIRONMENTAL SIZE 1 RECEPTACLE SHELL DIMENSIONS

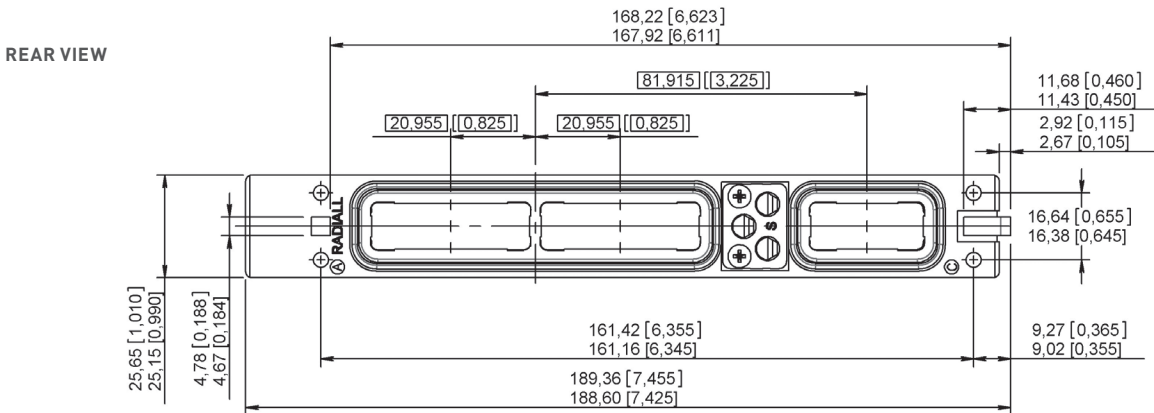
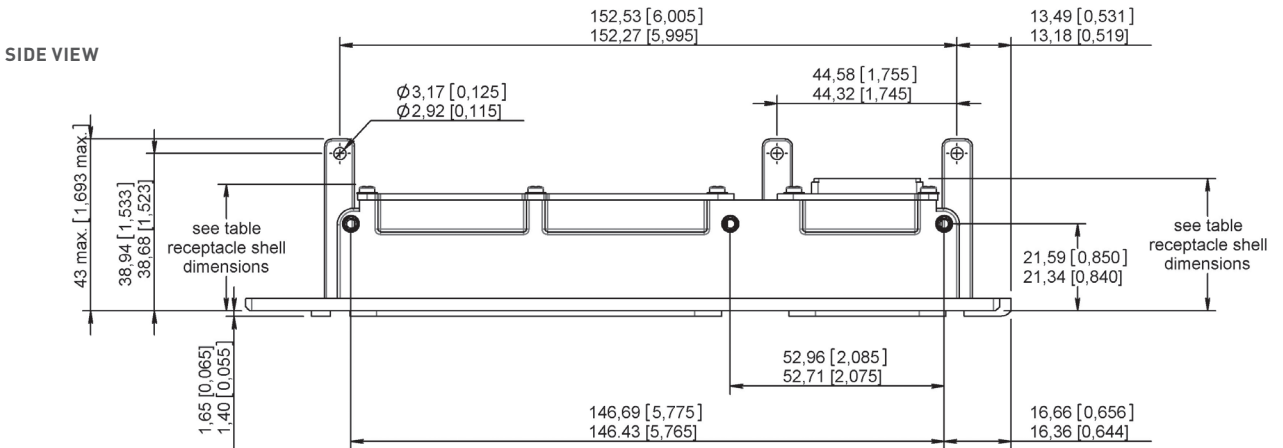
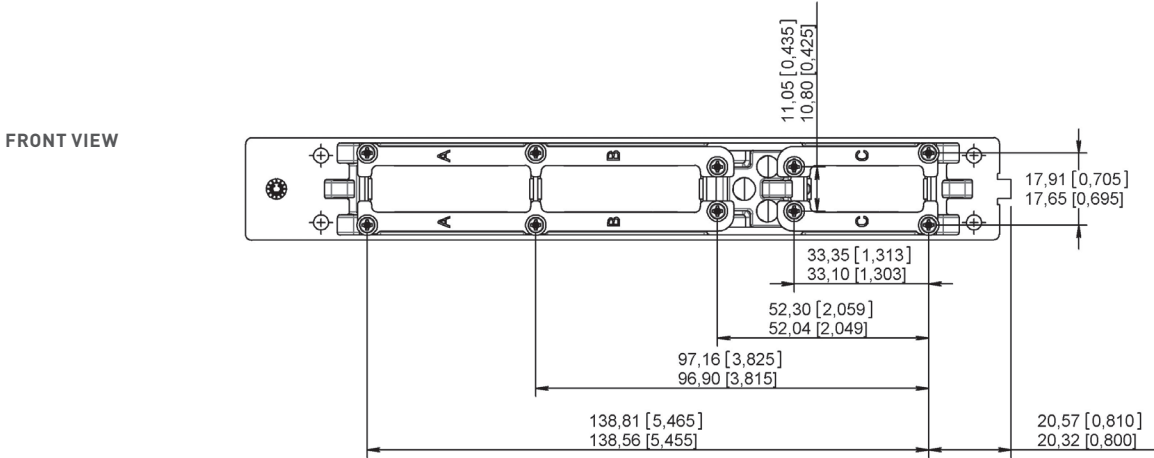

Dimensions

NON ENVIRONMENTAL SIZE 2 PLUG SHELL DIMENSIONS

NSX SERIES

FRONT VIEW

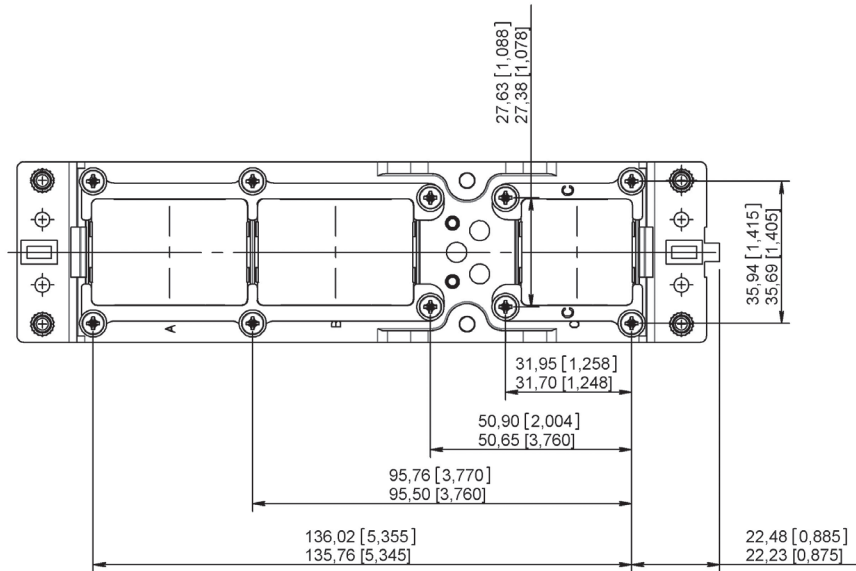

SIDE VIEW

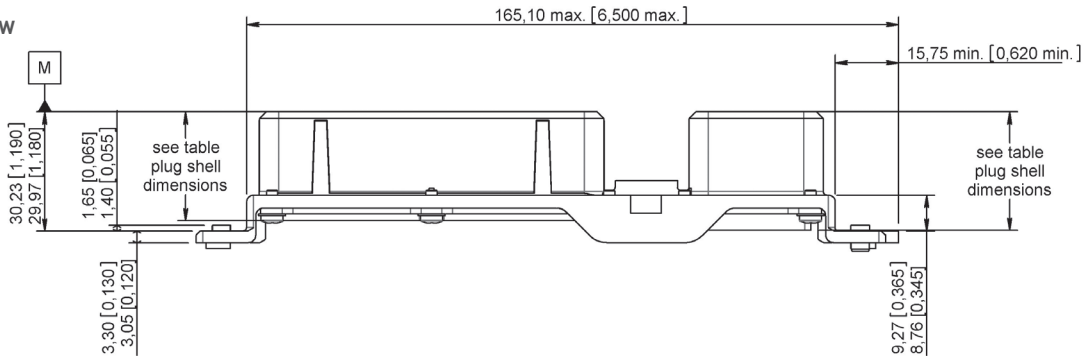

REAR VIEW

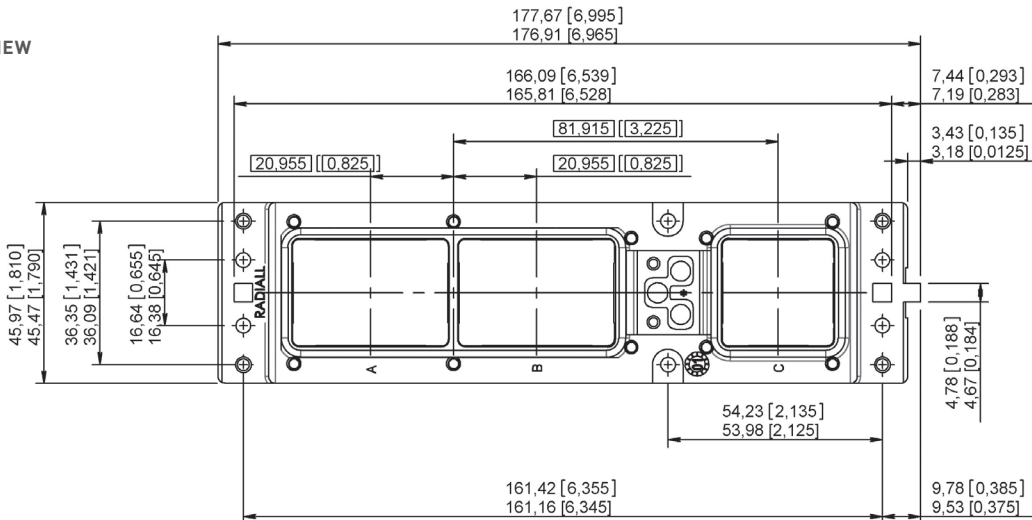

Dimensions

NON ENVIRONMENTAL SIZE 2 RECEPTACLE SHELL DIMENSIONS

FRONT VIEW

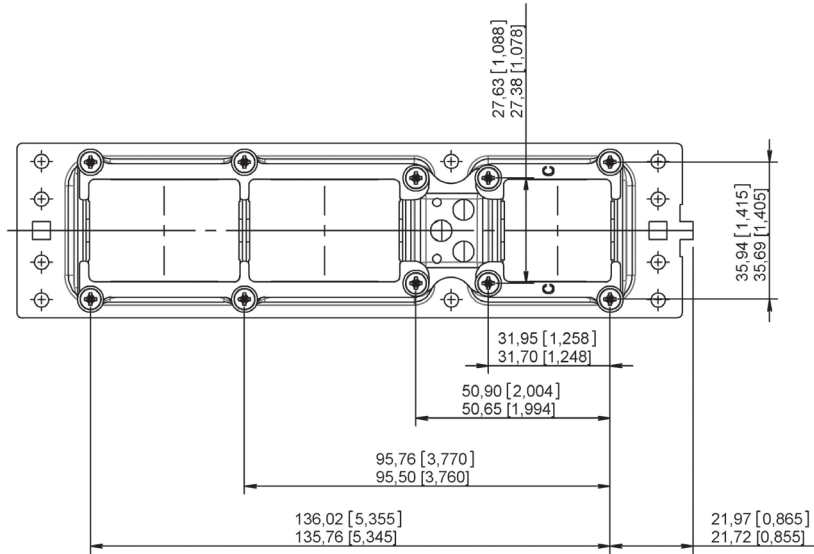

SIDE VIEW

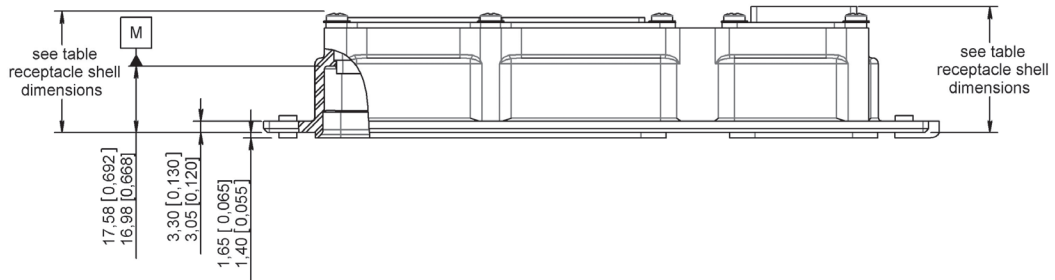

REAR VIEW

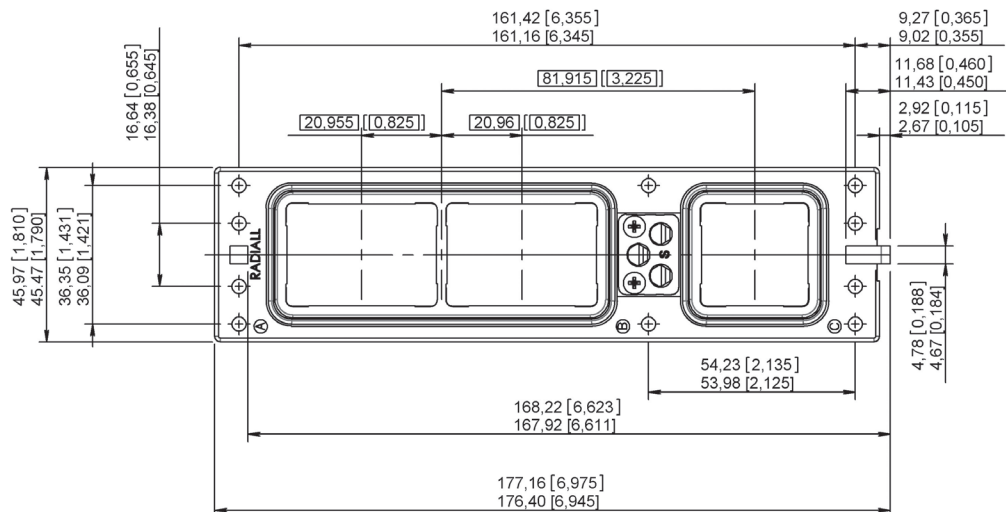

Dimensions

NON ENVIRONMENTAL SIZE 3 PLUG SHELL DIMENSIONS

NSX SERIES

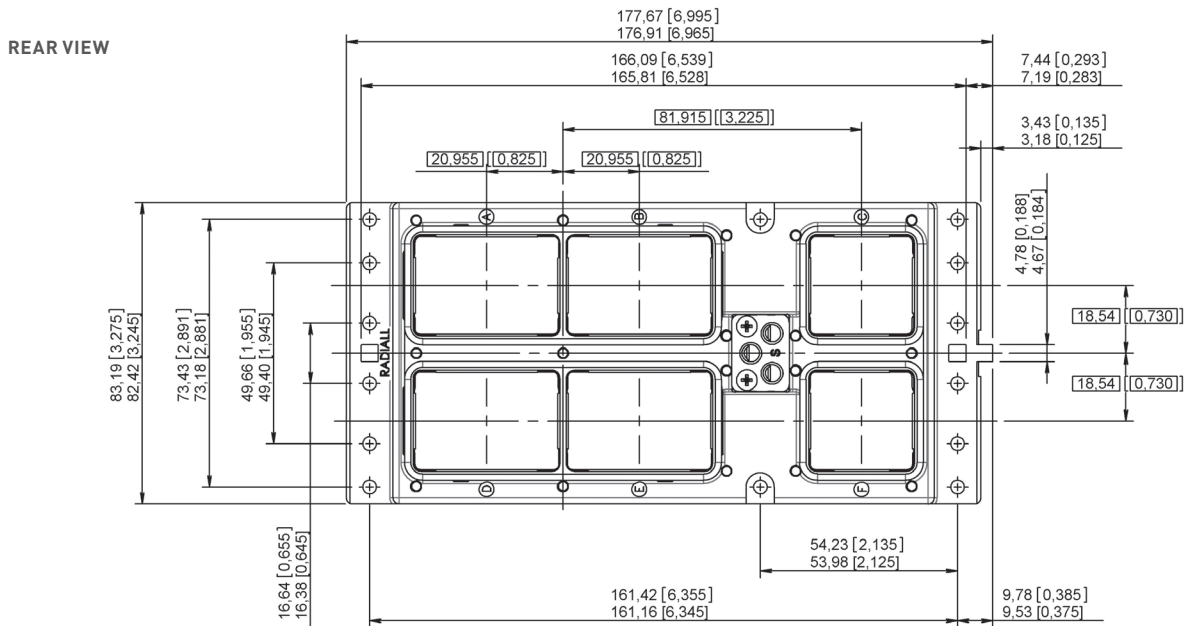
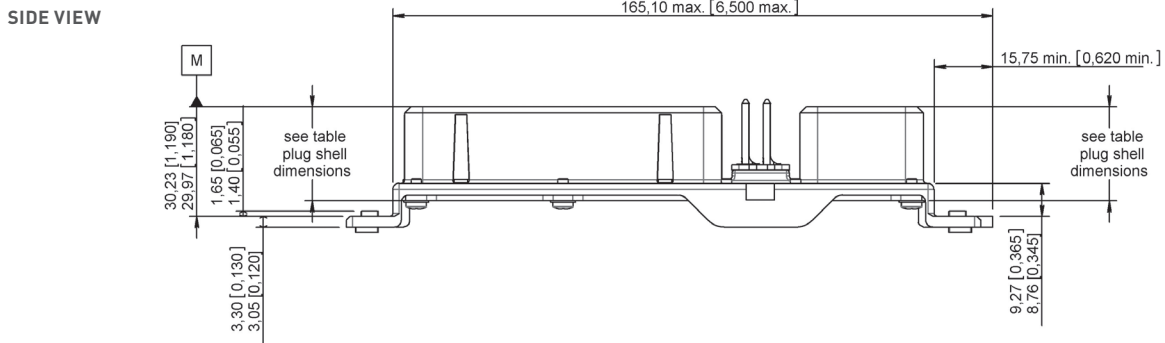
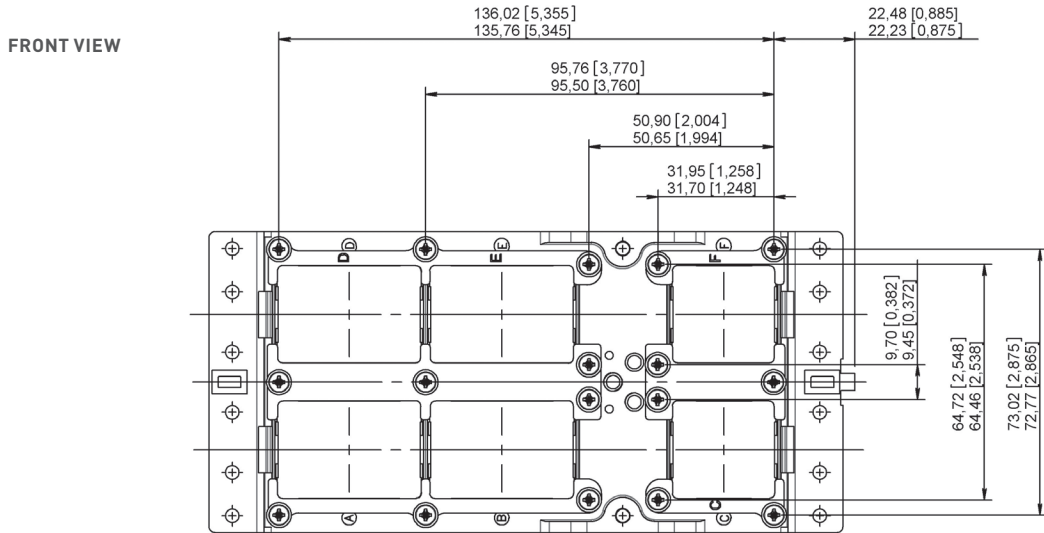

Dimensions

NON ENVIRONMENTAL SIZE 3 RECEPTACLE SHELL DIMENSIONS

FRONT VIEW

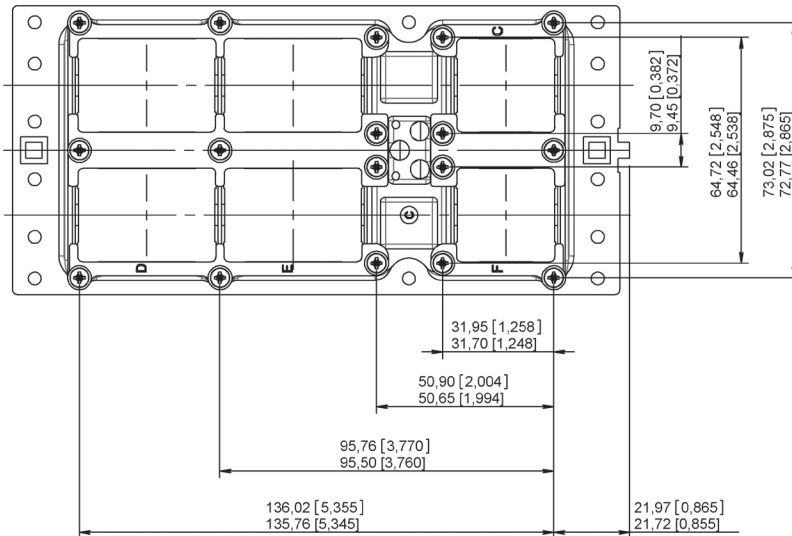

SIDE VIEW

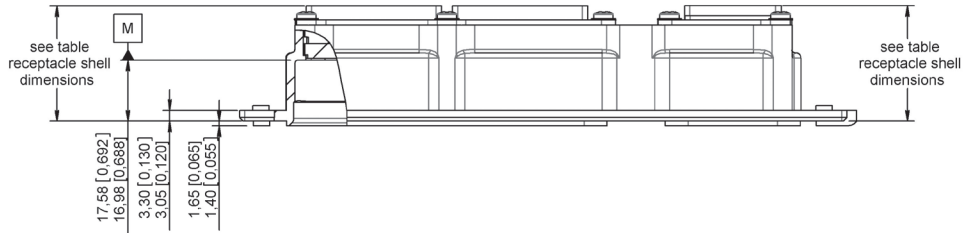

REAR VIEW

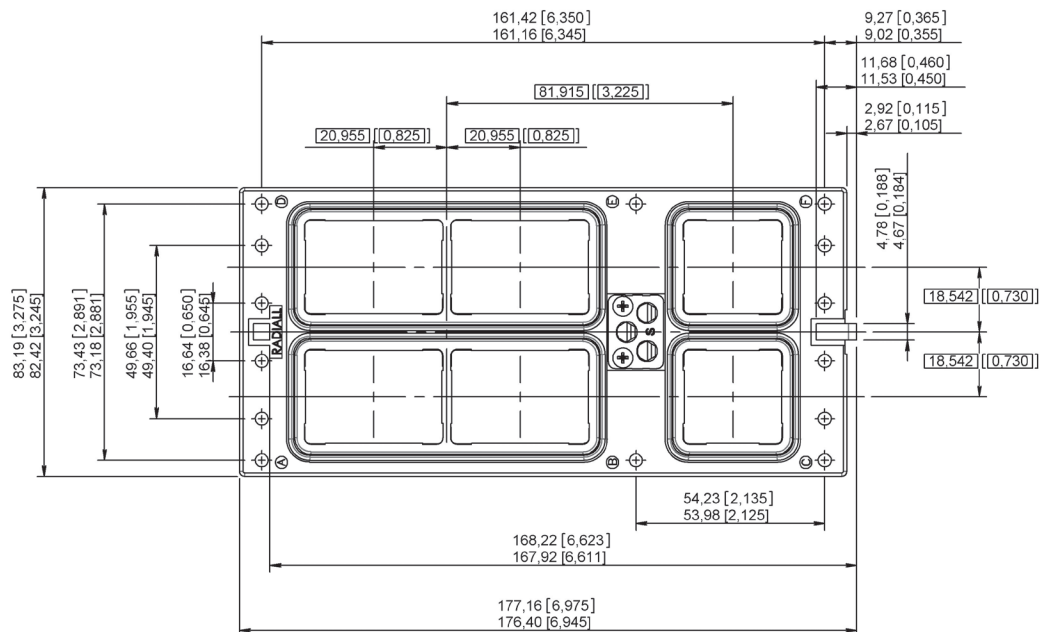

Dimensions

ENVIRONMENTAL SIZE 1 PLUG AND RECEPTACLE DIMENSIONS

RECEPTACLE SHELL

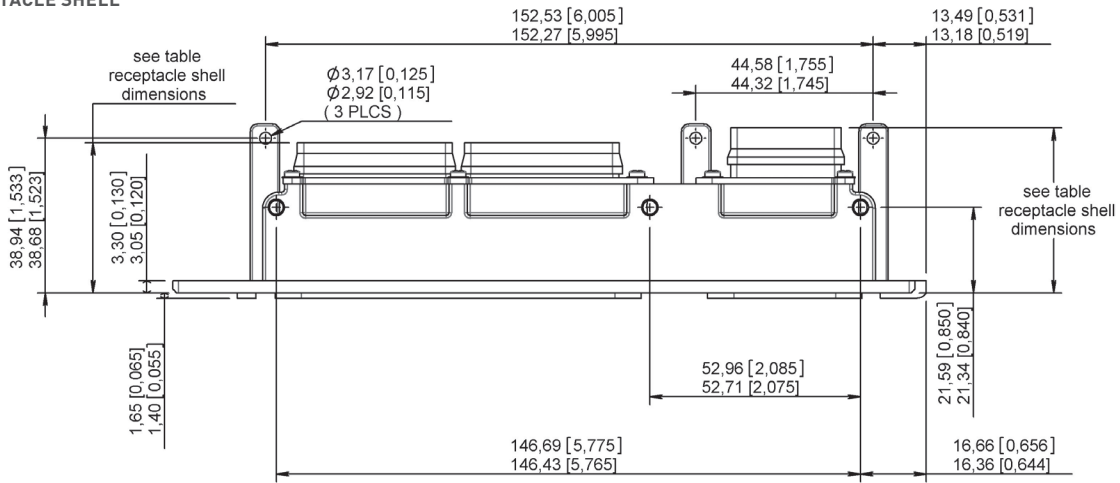

PLUG SHELL

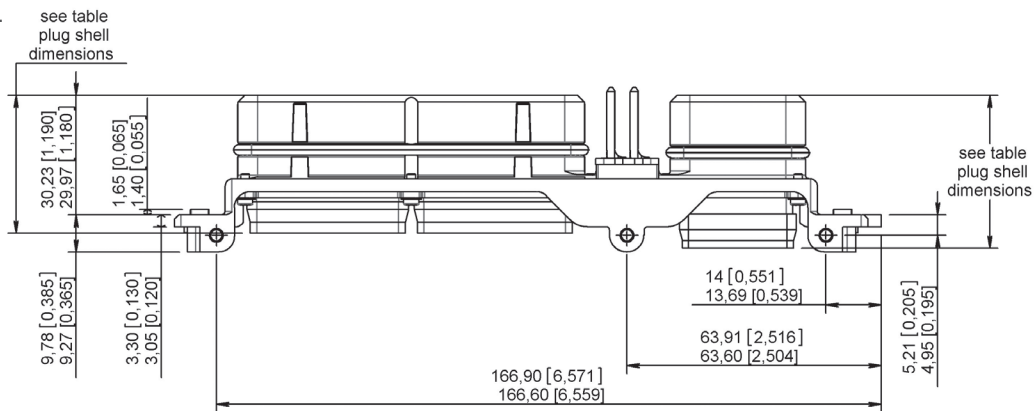

NSX SERIES

Dimensions

ENVIRONMENTAL SIZE 2 & 3 PLUG AND RECEPTACLE DIMENSIONS

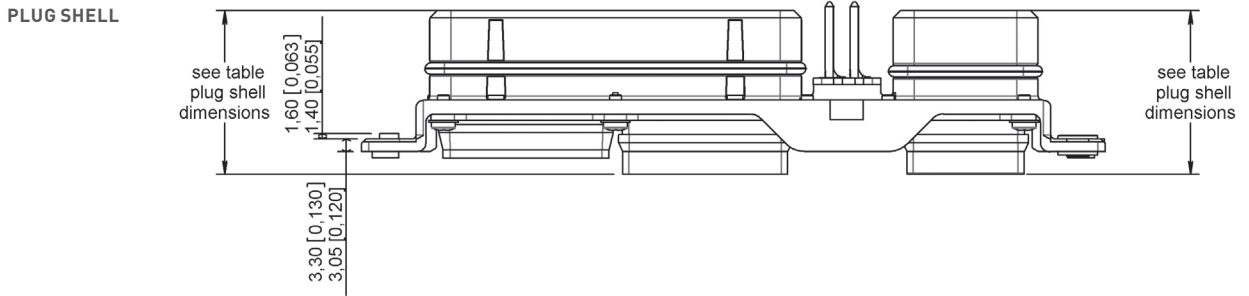
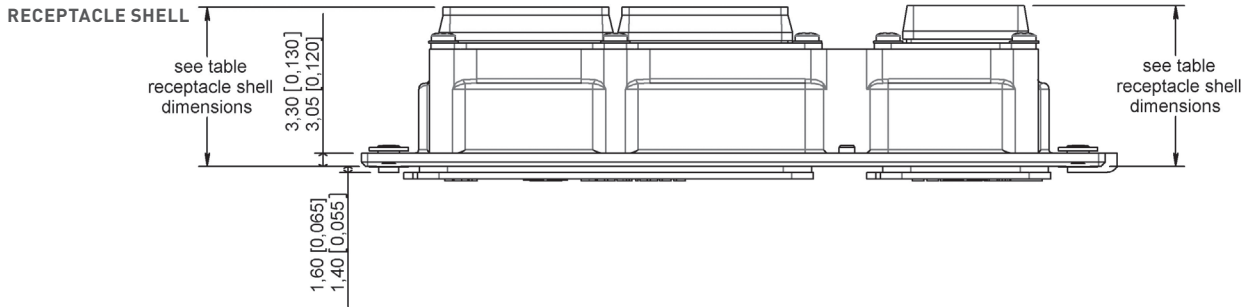

EMI/RFI NSX Size 1 Plug Dimensions

HOW TO ORDER

See page 4-11

NSX SERIES

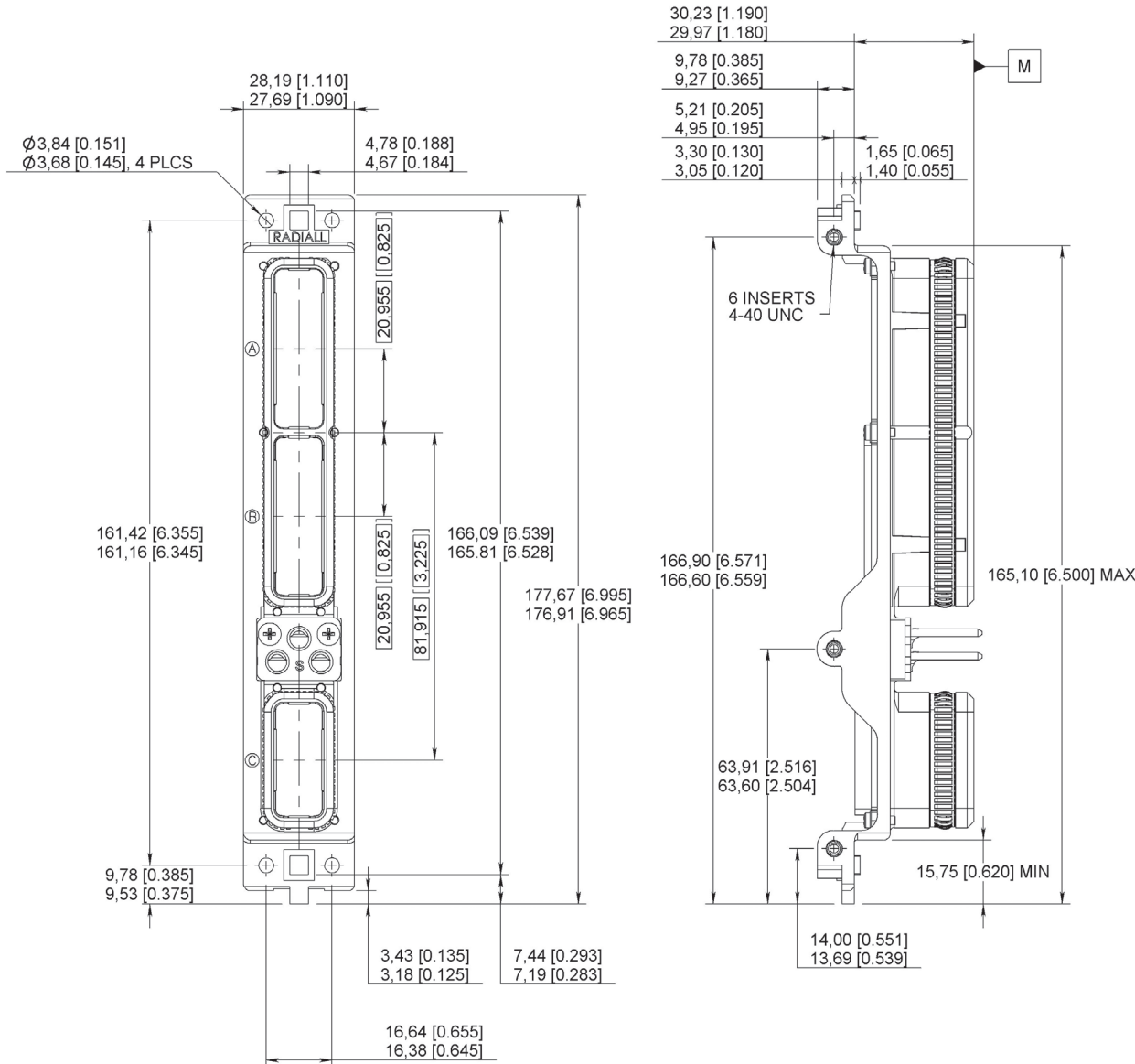

EMI/RFI NSX Size 2 Plug Dimensions

HOW TO ORDER

See page 4-11

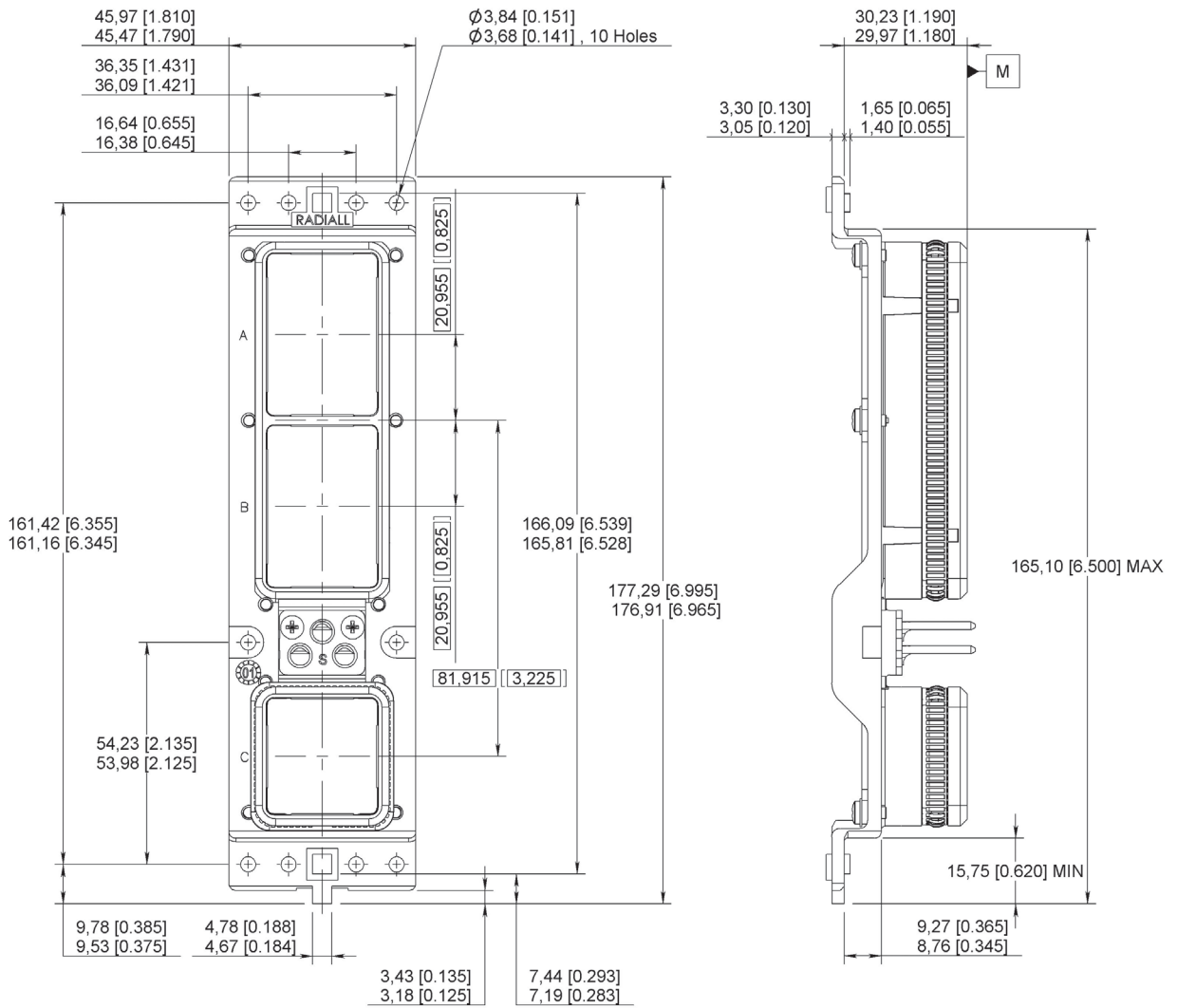

EMI/RFI NSX Size 3 Plug Dimensions

HOW TO ORDER

See page 4-11

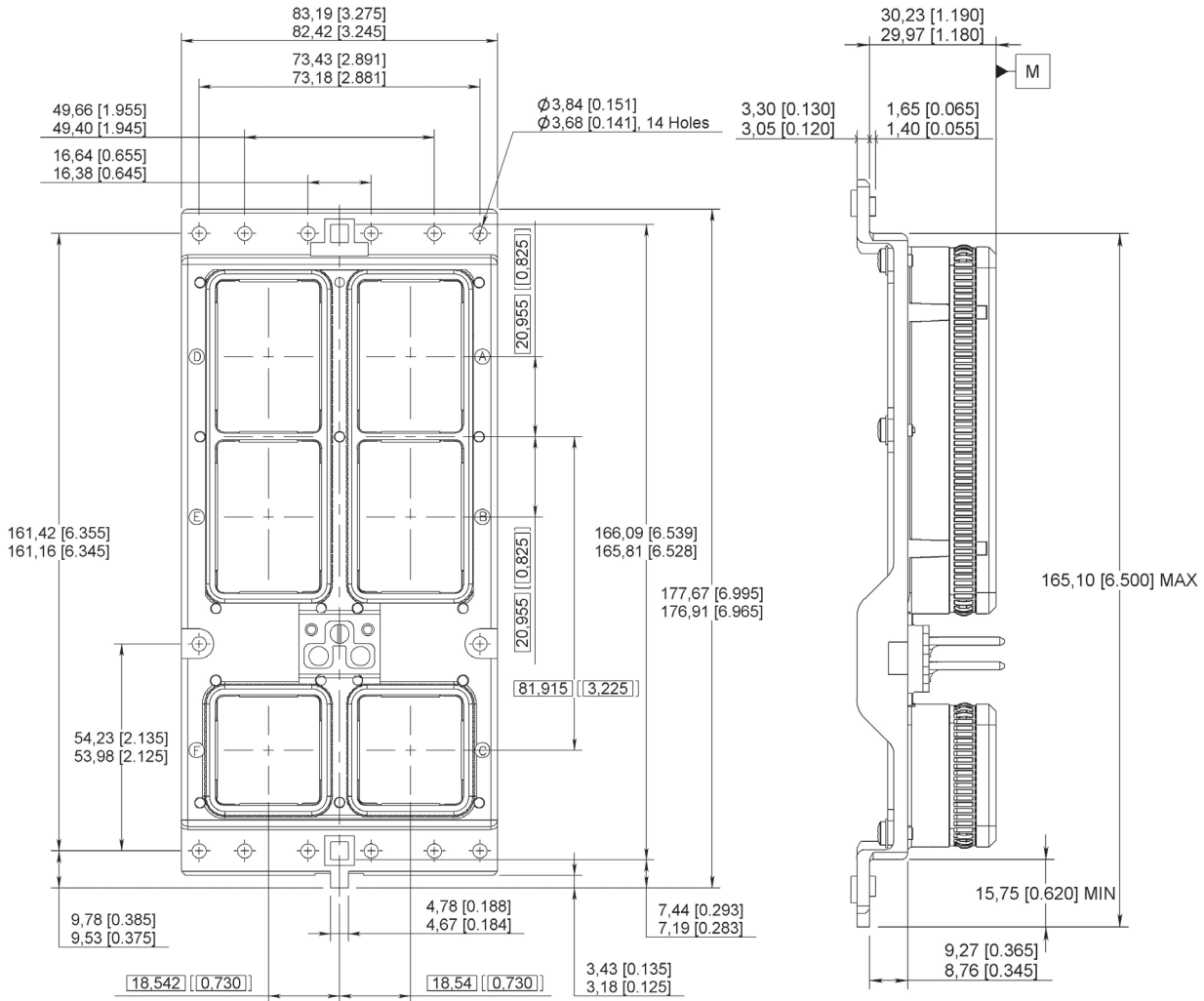

NSX SERIES

Dimensions

PLUG SHELL DIMENSIONS

Shell size	Cavity	Contact arrangement	Contact size	Class N mm (inch) max	Classe E,H,C mm (inch) max
1	A, B	60	22	28 (1.102)	35.5 (1.398)
		30T2	22	28 (1.102)	35.5 (1.398)
			8		36.8 (1.449)
	4C	5	30.5 (1.200)	-	
	C	5C2	16	30.5 (1.200)	39.3 (1.547)
			12		
			5		
40	22	28 (1.102)	35.5 (1.398)		
2, 3	A, B, D, E	150	22	28 (1.102)	35.5 (1.398)
		121	22	30.5 (1.200)	39.3 (1.547)
			20		
			16		
		120T2	22	28 (1.102)	35.5 (1.398)
			8		36.8 (1.449)
		118Q2	22	28 (1.102)	35.5 (1.398)
			8		36.8 (1.449)
		71C1	22	28 (1.102)	35.5 (1.398)
			1		-
		1C71	22	28 (1.102)	35.5 (1.398)
			1		-
		60	20	30.5 (1.200)	39.3 (1.547)
		24	12	30.5 (1.200)	39.3 (1.547)
		10T10	8	30.5 (1.200)	39.3 (1.547)
		Q11	8	30.5 (1.200)	39.3 (1.547)
		C2	1	28 (1.102)	-
		C4	1	28 (1.102)	-
		35	16	30.5 (1.200)	39.3 (1.547)
		110	22	30.5 (1.200)	-
			20		
			12		
		36F36	16 LuxCis®	30.5 (1.200)	39 (1.535)
20F12Q8	8	30.5 (1.200)	39 (1.535)		
	16 LuxCis®				

Dimensions

PLUG SHELL DIMENSIONS

Shell size	Cavity	Contact arrangement	Contact size	Class N mm (inch) max	Classe E,H,C mm (inch) max
2, 3	C, F	100	22	28 (1.102)	35.5 (1.398)
		85	22	28 (1.102)	35.5 (1.398)
			20		39.3 (1.547)
		34	16	30.5 (1.200)	39.3 (1.547)
			20		39.3 (1.547)
		20T4	16	30.5 (1.200)	39.3 (1.547)
			20		39.3 (1.547)
		20Q4	8	30.5 (1.200)	39.3 (1.547)
			20		39.3 (1.547)
		13C2	8	30.5 (1.200)	39.3 (1.547)
			20		39.3 (1.547)
			16		39.3 (1.547)
			12		39.3 (1.547)
		6T6	5	30.5 (1.200)	39.3 (1.547)
			8		39.3 (1.547)
		Q6	8	30.5 (1.200)	39.3 (1.547)
			8		39.3 (1.547)
		62Q2	22	28 (1.102)	36.8 (1.449)
			16		36.8 (1.449)
			8		36.8 (1.449)
		68Q2	22	28 (1.102)	35.5 (1.398)
			8		36.8 (1.449)
		11Q2	20	30.5 (1.200)	39.3 (1.547)
			16		39.3 (1.547)
			12		39.3 (1.547)
			8		39.3 (1.547)
		11WQ2	20	30.5 (1.200)	39.3 (1.547)
			16		39.3 (1.547)
			12		39.3 (1.547)
			8		39.3 (1.547)
59	22	28 (1.102)	35.5 (1.398)		
	16	30.5 (1.200)	39.3 (1.547)		
	12		39.3 (1.547)		
12F5C2	16 LuxCis®	30.5 (1.200)	39 (1.535)		
	16		39 (1.535)		
	5		39 (1.535)		
17F12Q2	16 LuxCis®	30.5 (1.200)	39 (1.535)		
	16		39 (1.535)		
	12		39 (1.535)		
	5		39 (1.535)		

NSX SERIES

Dimensions

RECEPTACLE SHELL DIMENSIONS

Shell size	Cavity	Contact arrangement	Contact size	Class N mm (inch) max	Class E, C mm (inch) max	Class F mm (inch) max	Class G mm (inch) max
1	A, B	60	22	31 (1.220)	38.9 (1.531)	30.93/29.84 (1.218/1.175)	-
		30T2	22	31 (1.220)	38.9 (1.531)	30.93/29.84 (1.218/1.175)	30.93/29.84 (1.218/1.175)
			8		40.5 (1.594)		
	4C	5	33.45 (1.317)	-	-	30.93/29.84 (1.218/1.175)	
	C	5C2	16	33.45 (1.317)	43 (1.693)	-	30.93/29.84 (1.218/1.175)
			12				
			5				
		40	22	31 (1.220)	38.9 (1.531)	30.93/29.84 (1.218/1.175)	-
	4	12	33.45 (1.317)	43 (1.693)	-	-	
	2, 3	A, B, D, E	150	22	31 (1.220)	38.9 (1.531)	30.93/29.84 (1.218/1.175)
121			22	31 (1.220)	38.9 (1.531)	30.93/29.84 (1.218/1.175)	30.93/29.84 (1.218/1.175)
			20	33.45 (1.317)	43 (1.693)	33.45 (1.317)	
			16				
120T2			22	31 (1.220)	38.9 (1.531)	30.93/29.84 (1.218/1.175)	-
			8	31 (1.220)	40.5 (1.594)	30.93/29.84 (1.218/1.175)	-
118Q2			22	31 (1.220)	38.9 (1.531)	30.93/29.84 (1.218/1.175)	-
			8	31 (1.220)	40.5 (1.594)	30.93/29.84 (1.218/1.175)	-
71C1			22	31 (1.220)	38.9 (1.531)	30.93/29.84 (1.218/1.175)	-
			1		-		
1C71			22	31 (1.220)	38.9 (1.531)	30.93/29.84 (1.218/1.175)	-
			1		-		
60			20	33.45 (1.317)	43 (1.693)	-	30.93/29.84 (1.218/1.175)
24			12	33.45 (1.317)	43 (1.693)	-	30.93/29.84 (1.218/1.175)
10T10			8	33.45 (1.317)	43 (1.693)	-	30.93/29.84 (1.218/1.175)
Q11			8	33.45 (1.317)	43 (1.693)	-	30.93/29.84 (1.218/1.175)
C2			1	31 (1.220)	-	-	-
C4			1	31 (1.220)	-	-	-
35			16	33.45 (1.317)	43 (1.693)	-	30.93/29.84 (1.218/1.175)
110			22	31 (1.220)	38.9 (1.531)	30.93/29.84 (1.218/1.175)	30.93/29.84 (1.218/1.175)
	20	33.45 (1.317)	43 (1.693)	33.45 (1.317)			
	12						

Dimensions

RECEPTACLE SHELL DIMENSIONS

Shell size	Cavity	Contact arrangement	Contact size	Class N mm (inch) max	Class E, C mm (inch) max	Class F mm (inch) max	Class G mm (inch) max		
2, 3	A, B, D, E	36F36	16 LuxCis®	35.5 (1.398)	44 (1.732)	-	-		
		20F12Q8	16 LuxCis®	35.5 (1.398)	44 (1.732)	-	30.93/29.84 (1.218/1.175)		
			8						
	C, F		100	22	31 (1.220)	38.9 (1.531)	30.93/29.84 (1.218/1.175)	-	
			85	22	31 (1.220)	38.9 (1.531)	30.93/29.84 (1.218/1.175)	30.93/29.84 (1.218/1.175)	
				20		40.5 (1.595)			
				16					
			34	20	33.45 (1.317)	43 (1.693)	-	30.93/29.84 (1.218/1.175)	
				16					
			20T4	20	33.45 (1.317)	43 (1.693)	-	30.93/29.84 (1.218/1.175)	
				8					
			20Q4	20	33.45 (1.317)	43 (1.693)	-	30.93/29.84 (1.218/1.175)	
				8					
			13C2	20	33.45 (1.317)	43 (1.693)	-	30.93/29.84 (1.218/1.175)	
				16					
				12					
				5					
			6T6	8	33.45 (1.317)	43 (1.693)	-	30.93/29.84 (1.218/1.175)	
			Q6	8	33.45 (1.317)	43 (1.693)	-	30.93/29.84 (1.218/1.175)	
			62Q2	22	31 (1.220)	38.9 (1.531)	40.5 (1.595)	30.93/29.84 (1.218/1.175)	30.93/29.84 (1.218/1.175)
				16					
				8					
			68Q2	22	31 (1.220)	38.9 (1.531)	40.5 (1.595)	30.93/29.84 (1.218/1.175)	30.93/29.84 (1.218/1.175)
				8					
	11Q2	20	33.45 (1.317)	43 (1.693)	-	30.93/29.84 (1.218/1.175)			
		16							
		12							
		8							
	11WQ2	20	33.45 (1.317)	43 (1.693)	-	30.93/29.84 (1.218/1.175)			
		16							
		12							
		8							
59	22	31 (1.220)	38.9 (1.531)	30.93/29.84 (1.218/1.175)	30.93/29.84 (1.218/1.175)				
	16	33.45 (1.317)	43 (1.693)	33.45 (1.317)					
	12								
12F5C2	16 LuxCis®	35.5 (1.398)	44 (1.732)	-	-				
	16								
	5								
17F12Q2	16 LuxCis®	35.5 (1.398)	44 (1.732)	-	30.93/29.84 (1.218/1.175)				
	16								
	12								
	5								

CLASS F: size 22 contacts are front release, front removable. Other sizes are rear release, rear removable
 CLASS G: all contacts are front release, front removable

NSX SERIES

Panel Cut Out

PANEL CUT OUT FOR PLUG SIZE 1, 2 AND 3

SIZE 3

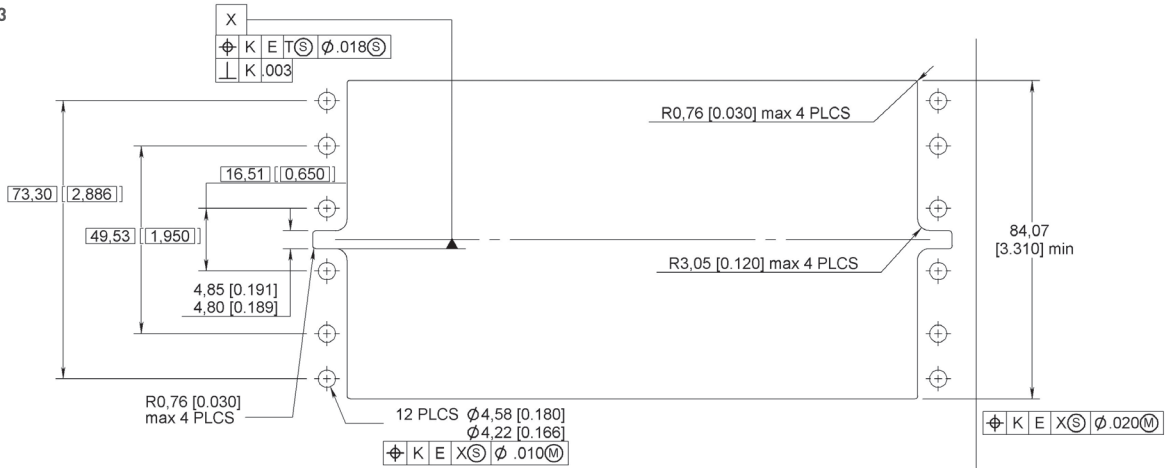

SIZE 2

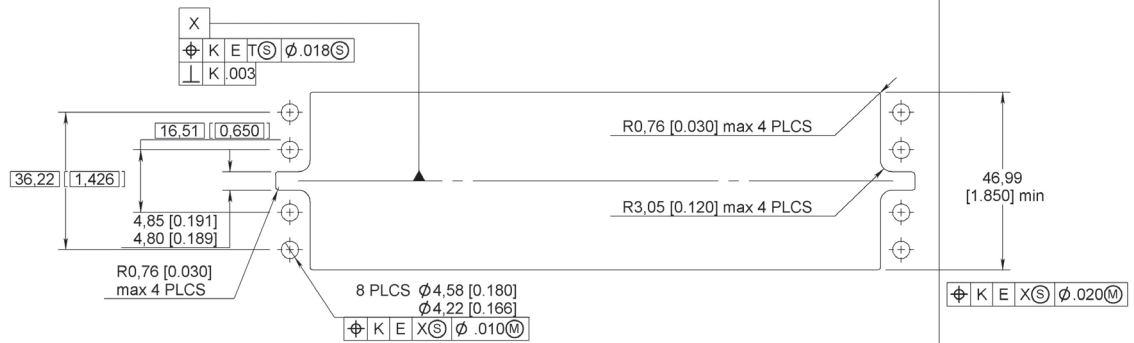

SIZE 1

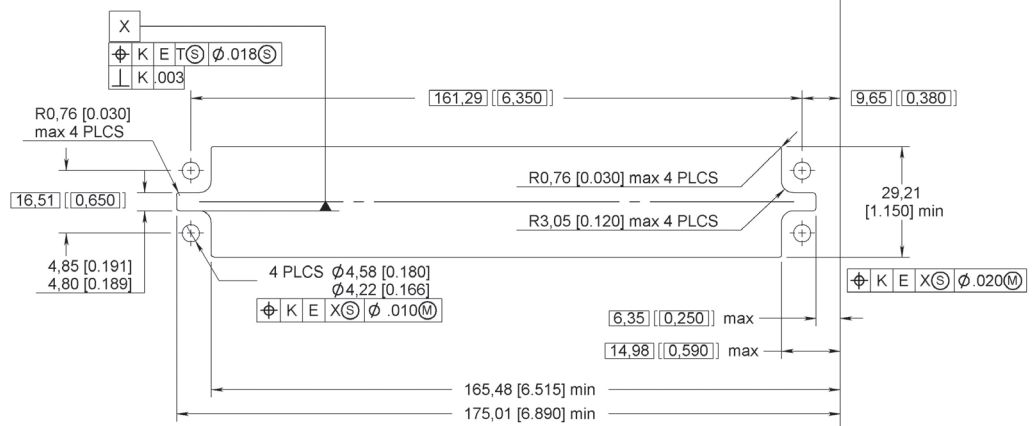

Panel Cut Out

PANEL CUT OUT FOR RECEPTACLE SIZE 1, 2 AND 3

NSX SERIES

SIZE 3

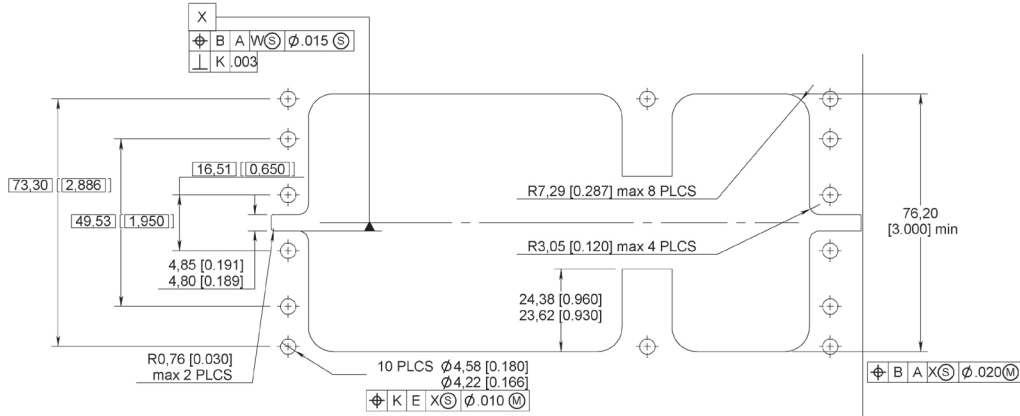

SIZE 2

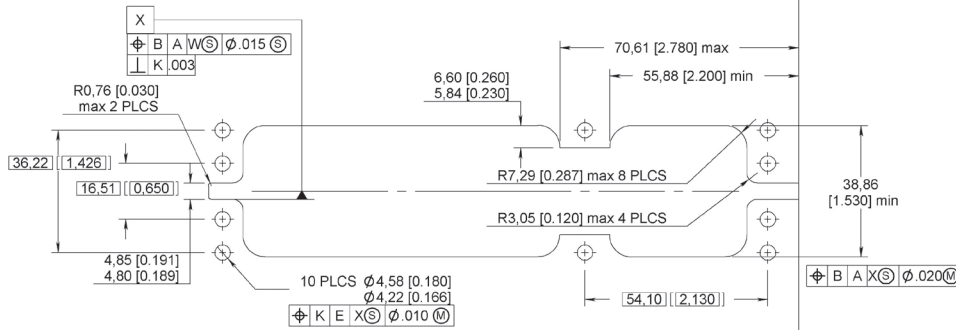

SIZE 1

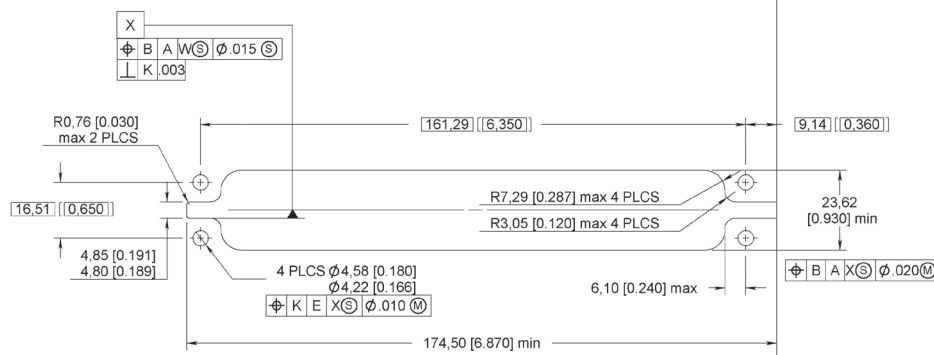

Tools

CRIMPING TOOLS

Part number	Crimping tools
282291	M22520/1.01
282281	M22520/2.01
282292	M22520/4.01
282293	M22520/5.01
/	M22520/23.01
/	M22520/31.01

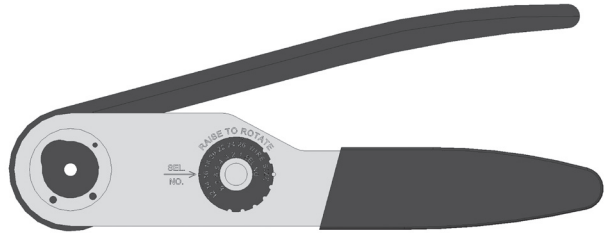

POSITIONERS

Part number	Mil spec P/N
282972	M22520/1.02
282579	M22520/1.11
282997	M22520/1.13
282971	M22520/2.08
282970	M22520/2.23
/	M22520/23.09
282550 (DANIELS K345)	/
282555 (DANIELS K370)	/
282556	/
282587	/
282588	/

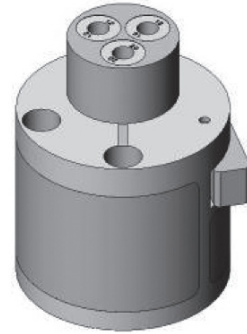

DIES

Part number	Mil spec P/N
282246	M22520/5.05
/	M22520/5.13
/	M22520/5.29
282236	M22520/5.45
282247	M22520/5.61
/	M22520/23.02
/	M22520/5.104

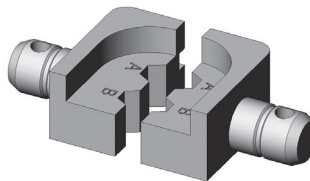

Tools

INSERTION/EXTRACTION TOOLS

Part number	Mil spec P/N	Description
282885	M81969/1.01	ins/ext tool for rear release rear removable size 22 contacts (crimp version)
282886	M81969/1.02	ins/ext tool for rear release rear removable size 20 contacts (crimp version)
282546	M81969/1.03	ins/ext tool for rear release rear removable size 16 contacts (crimp version)
282946	M81969/28.01	ins/ext tool for rear release rear removable size 5 coaxial contacts (metallic)
282500	/	ins/ext tool for front release front removable size 22 contacts
282503	/	ins/ext tool for front release front removable size 20 contacts
282504	/	ins/ext tool for front release front removable size 16 contacts
282549005	/	ins/ext tool for front release front removable size 12 contacts
282890	/	ins/ext tool for rear release size 22 contacts solder tail and wire wrap terminations
282549011	/	insertion tool for front release front removable size 8 triaxial contacts, solder tail version
282549004	M81969/14.04	extraction tool for rear release rear removable size 12 contacts
/	M81969/19.02	extraction tool for front release rear removable size 12 power contacts
/	M81969/19.03	extraction tool for front release rear removable size 8 contacts
282549001	M81969/28.03	extraction tool for rear release rear removable size 8 contacts
282549004	/	extraction tool for rear release rear removable size 12 contacts (crimp version)
282548	/	extraction tool for rear release rear removable size 5 coaxial contacts
282549009	/	extraction tool for front release front removable size 8 triaxial contacts
282549012	/	extraction tool for front release rear removable size 8 triaxial contacts
282892	/	extraction tool for rear release rear removable size 16 coaxial contacts
282945	/	extraction tool for rear release rear removable size 12 coaxial contacts
282548	/	extraction tool for rear release rear removable size 5 coaxial contacts (plastic)

NSX SERIES

Accessories

EMI BACKSHELLS

Radiall is proud to introduce two ways to integrate EMI backshells on Arinc 600 connectors:

- Backshell adapters plates
- Radiall backshell solution

Backshell adapters plates:

Backshell adapters plates can be delivered with NSX connectors when choosing modification code 60 and 61.

Combination Code	Receptacle shell		Plug shell	
60 (1)	--	--		Shell size 1: Q ^y = 4 holes Ø3.76 (.148) & Q ^y = 6 4-40 UNC 2B Shell size 2: Q ^y = 10 holes Ø3.76 (.148) Shell size 3: Q ^y = 14 holes Ø3.76 (.148) delivered with backshell adapters plates
61 (1)	--	--		Shell size 1: Q ^y = 4 6-32 UNC Shell size 2: Q ^y = 6 holes Ø3.76 (.148) & Q ^y = 4 6-32 UNC Shell size 3: Q ^y = 6 holes Ø3.76 (.148) & Q ^y = 8 6-32 UNC delivered with backshell adapters plates

Radiall backshell solution





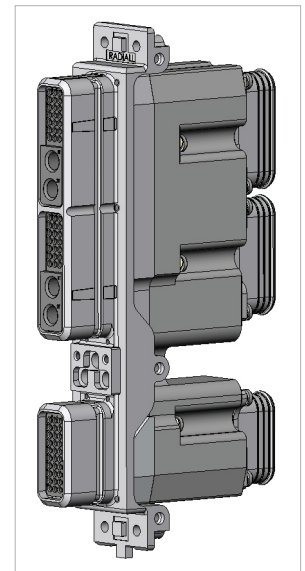



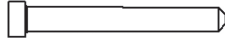
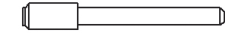
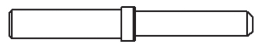

- High EMI performances
- Easy installation and maintenance with:
 - Modular backshells (1 or 2 pieces backshells)
 - Captive screws
- Available on size 1, 2 and 3 Arinc 600 connectors
- Round or oblong chimneys

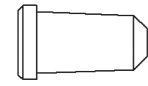
Please, contact Radiall for more information about NSX backshells

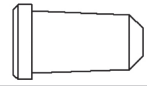
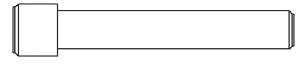
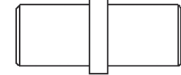

Accessories

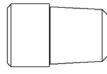
FILLER PLUGS (Non environmental)

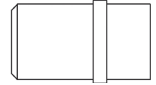

Size	Contact cavity version	Ins	Ext	Color/Type	Part Number	Drawing
22	for pin & socket	rear	rear	black	620920	← 
	for socket	front	front	aluminium	620919	 →
	for socket	front	front	white	620926	 →
20	for pin & socket	rear	rear	red	620921	← 
	for pin & socket	front	front	white	620934001	 →
16	for pin & socket	rear	rear	blue	620922	← 
	for pin & socket	front	front	white	620935001	 →
12	for pin & socket	rear	rear	yellow	620923	← 
	for pin	front	front	white	620936001	 →
	for pin	front	front	nickel	620936002	 →
8	for pin	rear	rear	nickel	619953	← 
	for pin	front	front	nickel	619552	 →
	for socket	rear	rear	nickel	619950	← 
5	for pin	rear	rear	white	620924	← 
	for socket	rear	rear	white	620925	← 
	for pin & socket	front	front	white	620937001	-  →

NSX SERIES

Accessories

SEALING PLUGS (Environmental)

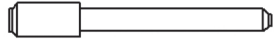
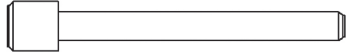
Sealing plugs are dedicated to environmental inserts.

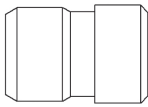
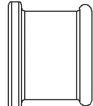

Size	Contact cavity version	Ins	Ext	Color/Type	Part Number	Drawing
22	for pin & socket	rear	rear	black	616910	← 
20	for pin & socket	rear	rear	red	616911	← 
16	for pin & socket	rear	rear	green	616912	← 
12	for pin & socket	rear	rear	orange	616913	← 
8	for pin & socket	rear	rear	red	618915	← 
5	for pin & socket	rear	rear	red	616914014	← 

The arrow shows the direction which you have to insert the plug

Accessories

DUMMY INSERTS

When a cavity shell is not fitted with one of the inserts shown on pages 4-12 to 4-21, the cavity shell is fitted with a dummy insert. Dummy inserts are made of aluminium alloy and are available for each cavity shell in ALODINE 1200, nickel or RoHS plating.

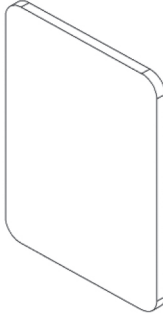
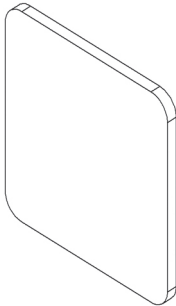





Shell size	Cavity	Dummy insert P/N	Figure
1	A or B	620910 (Alodine 1200) 620913001 (nickel) 620913005 (RoHS)	
	C	620911 (Alodine 1200) 620913002 (nickel) 620913006 (RoHS)	
2 & 3	A or B or D or E	620912 (Alodine 1200) 620913003 (nickel) 620913007 (RoHS)	
	C or F	620913 (Alodine 1200) 620913004 (nickel) 620913008 (RoHS)	

NSX SERIES

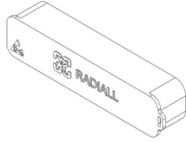
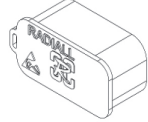
Accessories

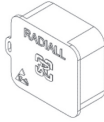
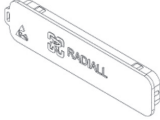
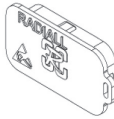

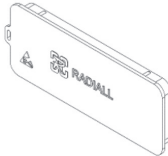



DUST CAPS

Dust caps are made of thermoplastic. They are available either conductive (black color) or not (red color).

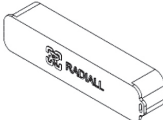
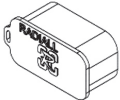
Electrical characteristics	Shell type	Shell size	Shell cavity	Part number	Figure
Conductive	Plug	1	A/B	620995003	
			C	620995004	
		2 & 3	A/B & D/E	620995007	
			C & F	620995008	
	Receptacle	1	A/B	620995011	
			C	620995012	
		For single shell connector	-	620995018	
		2 & 3	A/B & D/E	620995015	
			C & F	620995016	

Accessories

DUST CAPS

Electrical characteristics	Shell type	Shell size	Shell cavity	Part number	Figure
Non conductive	Plug	1	A/B	620995001	
			C	620995002	
		For single shell connector	-	620995017	
		2 & 3	A/B & D/E	620995005	
			C & F	620995006	
		Receptacle	1	A/B	620995009
	C			620995010	
	2 & 3		A/B & D/E	620995013	
			C & F	620995014	

NSX SERIES

Accessories

CAVITY REDUCERS

The following parts are cavity reducers which allows the use of a size 12 contact in a size 5 cavity. These parts are made of copper alloy and are plated with gold over nickel. Once installed, they cannot be removed.

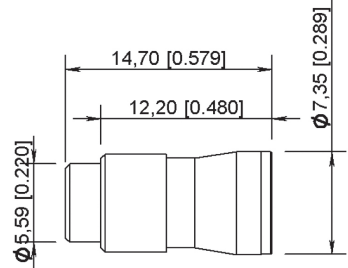
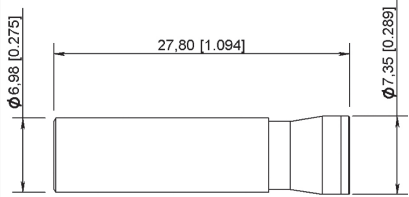
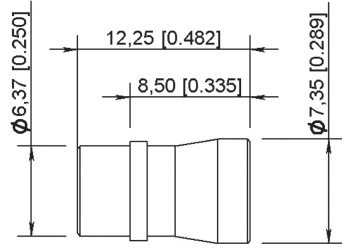
Electrical characteristics	Part number	Figure
For pin contact	620940	
For socket contact	620941	
For pin contact front release / front removable (FR/FR) connector in version G	620942	

Accessories

SEALING BOOTS

The sealing boots are designed to slide down over the back of the crimped contacts after they have been installed in the connector. The assembly provides bend support and moisture sealing to the contact / cable assembly. Sealing boots are made of fluorosilicon rubber.

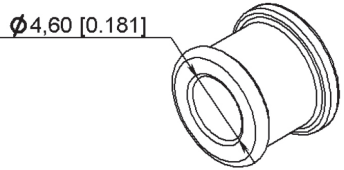
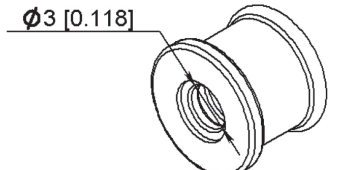
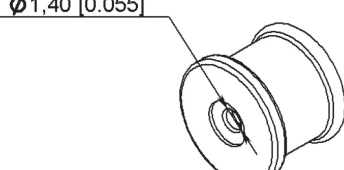
Electrical characteristics	Cable outside dia. mm (inch)	Cable	Part number	Figure
5	5 [0.197]	RG 58 RG 141 RG 142 RG 223 RG 400	620939201	
	3.81 [0.150]	RG 180 RG 195	620939200	
	2.59 [0.102] & 2.01 [0.079]	RG 179 RG 316 KX 21	620914001	

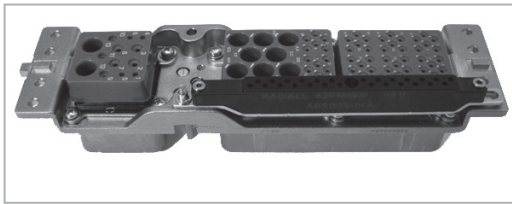

GROUNDING BLOCK (part number 620981002)

Radiall provides a unique feature by integrating a ground block directly on the plug shell for sizes #2 & #3. This option allows very short ground terminations. Pin crimp ground contacts are available with grounding block, part number is 620260 (up to 26 contacts per grounding block).

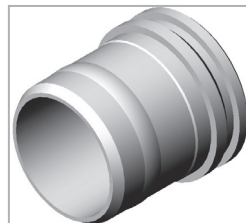

ALIGNMENT BOOTS (part number 619960)

Alignment boots are designed to reduce the play at the top of the size 8 pin contacts. They are used with non environmental rear release/ rear removable size 8 pin contacts.

Introduction

NSX – SINGLE SHELL CONNECTOR

NSX single shell connectors are designed to accommodate all large cavity inserts. Their characteristics are shown on page 4-8 except for the following.



Materials

Description	Material	Plating
Shell	Aluminum alloy	Cadmium clear chromate or nickel
Insert retention plate	Aluminum alloy	Cadmium clear chromate or nickel
Polarization posts and keys retention plate	Aluminum alloy	Cadmium clear chromate or nickel
Screws washers and clinch-nuts	Stainless steel	/
	Steel	Cadmium clear chromate
Polarization posts and keys	Zinc alloy	Cadmium yellow chromate or nickel

How to Order Connector

NSX – SINGLE SHELL CONNECTOR

NSX	N	P	150	S	00	01
-----	---	---	-----	---	----	----

Series _____

Class _____

- N:** Non environmental (rear removable version only)
- E:** Environmental, with grommets and compound. plug with O-ring (rear removable version only).
- H:** Environmental plug without O-ring } front removable
- C:** Non environmental with grommets } rear removable
- F:** Non environmental receptacle shell } rear removable
- G:** Non environmental receptacle shell }

Shell style _____

- R:** Cadmium clear chromate plated receptacle
- P:** Cadmium clear chromate plated plug
- F:** Nickel plated receptacle
- B:** Nickel plated plug
- M:** Nickel plated plug EMI/RF1 solution (see page 4-96)

Contact arrangement _____

See contact arrangements on pages 4-12 to 4-21
Only use insert for A & B cavities

Contacts termination ⁽¹⁾ _____

Without contacts

- X:** Without contacts
- S:** Crimp contacts

Wire wrap

- K:** Wire wrap contact, 1 level (1 = .272)
- V:** Wire wrap contact, 2 levels (1 = .390)
- W:** Wire wrap contact, 3 levels (1 = .524)

PC tail contacts

RoHs	Gold	Pre-tinned	Length (inch)
RA	YA	ZA	.150
R	Y	Z	.250
RB	YB	ZB	.375
RC	YC	ZC	.500

Modification code _____

- 00:** 4 mounting holes .146/.156 dia
- 01:** 4 clinch nuts 4.40 UNC
- 03:** 4 each .122 dia mounting holes c'sunk .230 dia x 100°
- 04:** 4 each .122 dia mounting holes c'sunk .230 dia x 82°
- 05:** 4 each .137 dia mounting holes c'sunk .230 dia x 82°
- 23:** 4 floating eyelets .122 - .126 dia

Polarization code ⁽²⁾ _____

See pages 4-92 to 4-93
Without code: polarization hardware is delivered unassembled

NOTES:

- (1) For F class receptacle, only size 22 contacts can be delivered in PC Tail version, others contacts (size 20, 16, 12) will be delivered in crimp version. Coaxial, twinax and quadrax contacts are ordered separately
For G class receptacle, every contacts can be delivered in PC Tail or crimp version except size 1 that will be delivered in crimp version only.
Coax twinax and power contacts size are ordered separately
- (2) Without polarization code, the connector is delivered polarization hardware unassembled
Polarization code 00, the connector is delivered without polarization hardware.
Polarization code 01 to 36, the connector is delivered with the polarization hardware assembled as defined by the code

Horizontal Installation

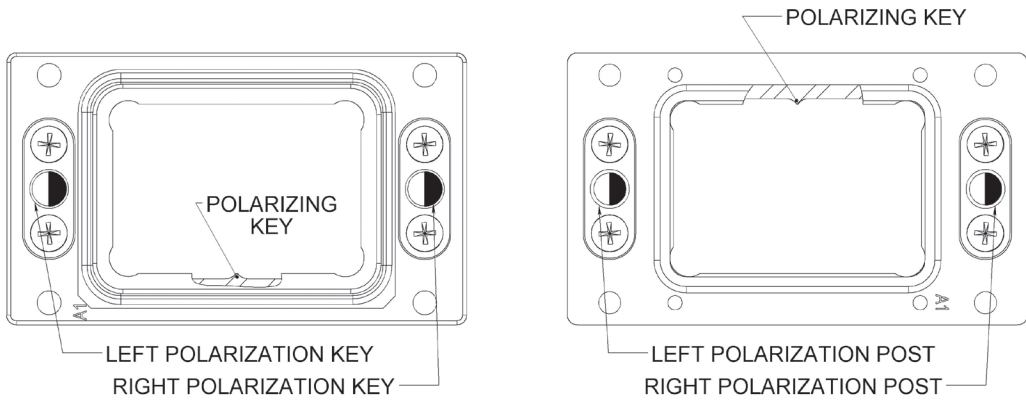

MATING FACE

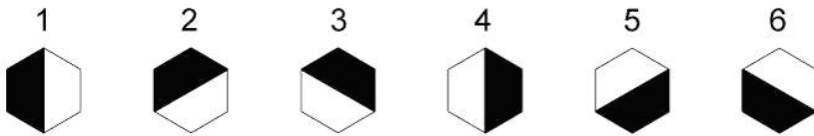

POSITION OF POST (DARK) AND KEYHOLE (LIGHT)

Position	Equipment receptacle		Rack plug	
	Left. key	Right. key	Left. post	Right. post
01	1	1	1	1
02	3	4	4	5
03	2	4	4	6
04	1	4	4	1
05	6	4	4	2
06	5	4	4	3
07	4	5	3	4
08	3	5	3	5
09	2	5	3	6
10	1	5	3	1
11	6	5	3	2
12	5	5	3	3
13	4	6	2	4
14	3	6	2	5
15	2	6	2	6
16	1	6	2	1
17	6	6	2	2
18	5	6	2	3
19	4	1	1	4
20	3	1	1	5
21	2	1	1	6
22	4	4	4	4
23	6	1	1	2
24	5	1	1	3
25	4	2	6	4
26	3	2	6	5
27	2	2	6	6
28	1	2	6	1
29	6	2	6	2
30	5	2	6	3
31	4	3	5	4
32	3	3	5	5
33	2	3	5	6
34	1	3	5	1
35	6	3	5	2
36	5	3	5	3

Vertical Installation

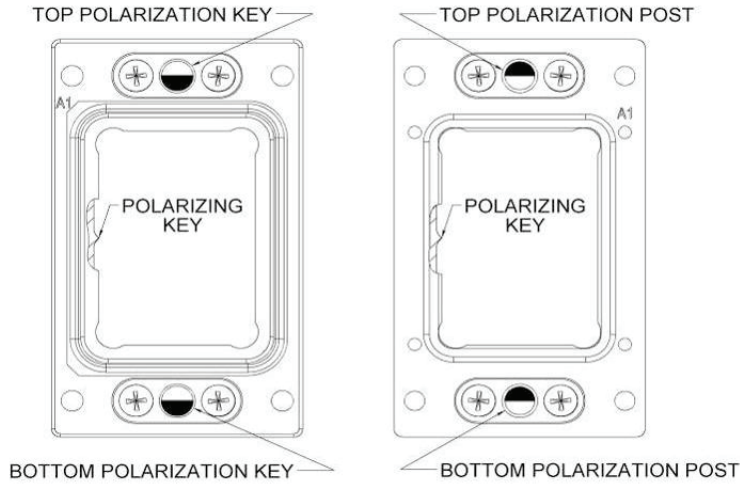

MATING FACE

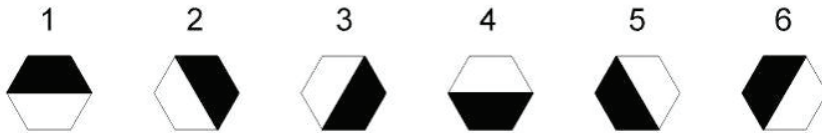

POSITION OF POST (DARK) AND KEYHOLE (LIGHT)

Position	Equipment receptacle		Rack plug	
	Left. key	Right. key	Left. post	Right. post
01	1	1	4	4
02	3	4	2	1
03	2	4	3	1
04	1	4	4	1
05	6	4	5	1
06	5	4	6	1
07	4	5	1	6
08	3	5	2	6
09	2	5	3	6
10	1	5	4	6
11	6	5	5	6
12	5	5	6	6
13	4	6	1	5
14	3	6	2	5
15	2	6	3	5
16	1	6	4	5
17	6	6	5	5
18	5	6	6	5
19	4	1	1	4
20	3	1	2	4
21	2	1	3	4
22	4	4	1	1
23	6	1	5	4
24	5	1	6	4
25	4	2	1	3
26	3	2	2	3
27	2	2	3	3
28	1	2	4	3
29	6	2	5	3
30	5	2	6	3
31	4	3	1	2
32	3	3	2	2
33	2	3	3	2
34	1	3	4	2
35	6	3	5	2
36	5	3	6	2

Dimensions

NSX SINGLE SHELL RECEPTACLE DIMENSIONS

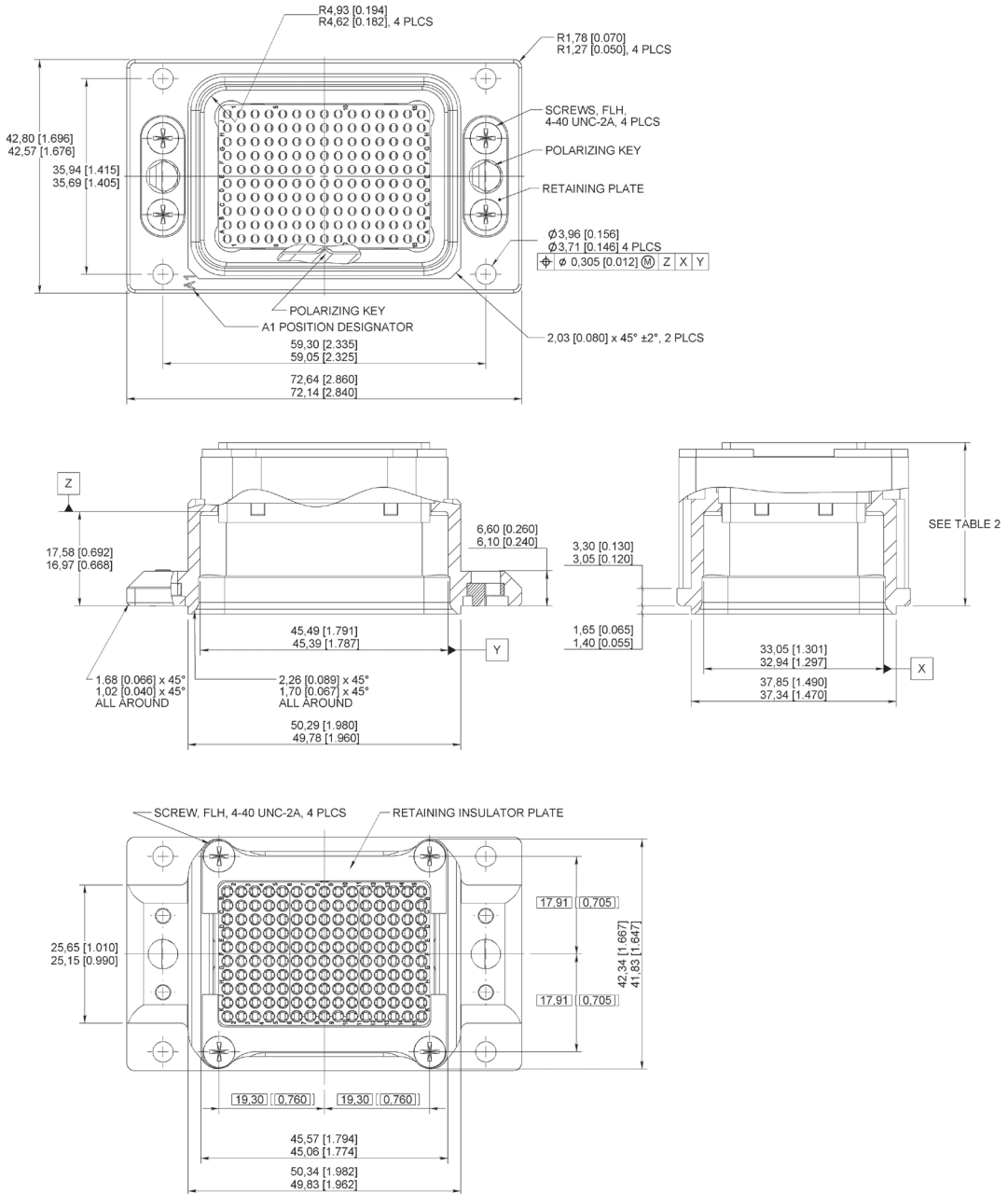

Dimensions

NSX SINGLE SHELL PLUG DIMENSIONS

NSX SERIES

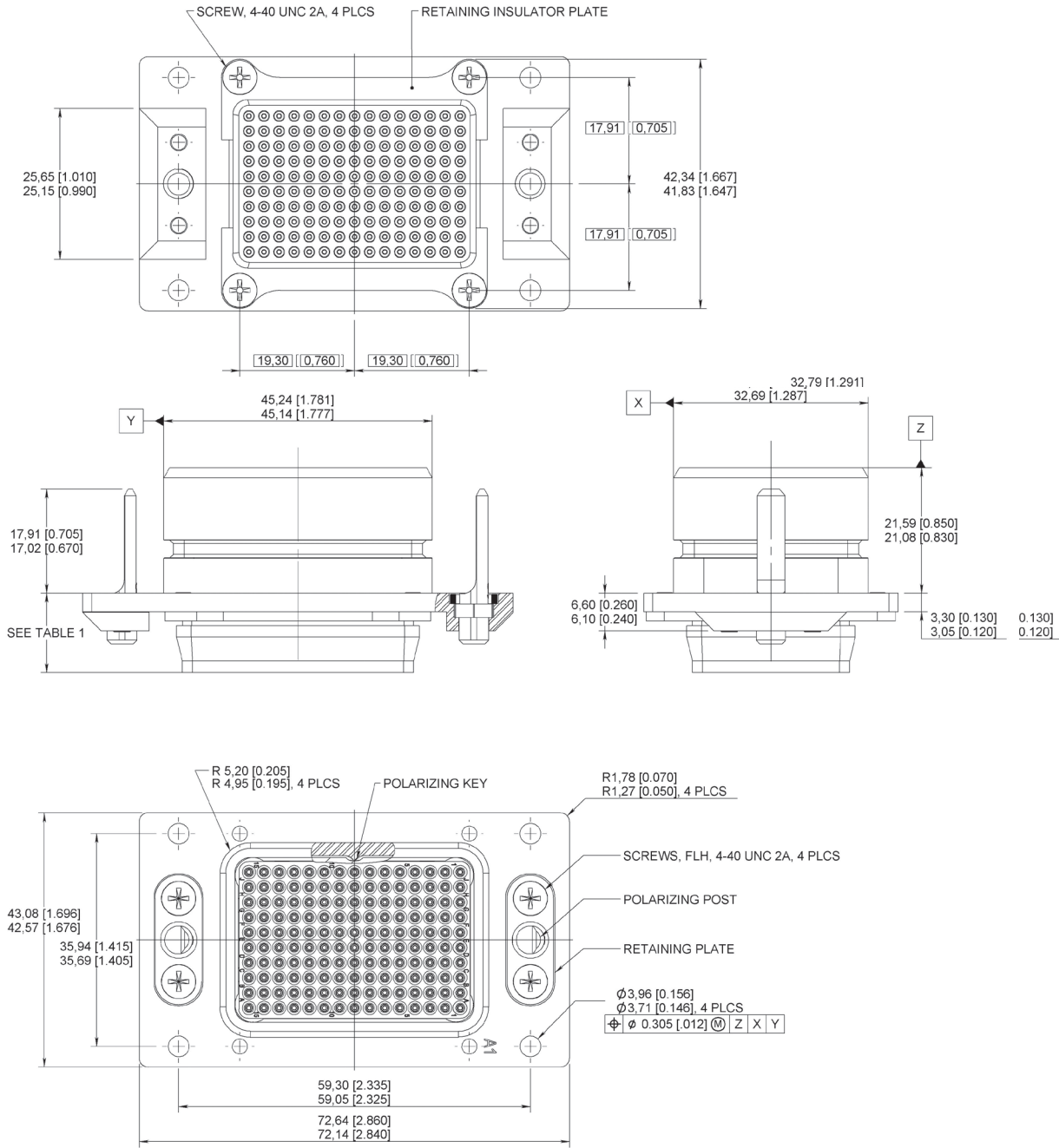

NSX Single Shell Panel Cut Out

RECEPTACLE PANEL CUT OUT

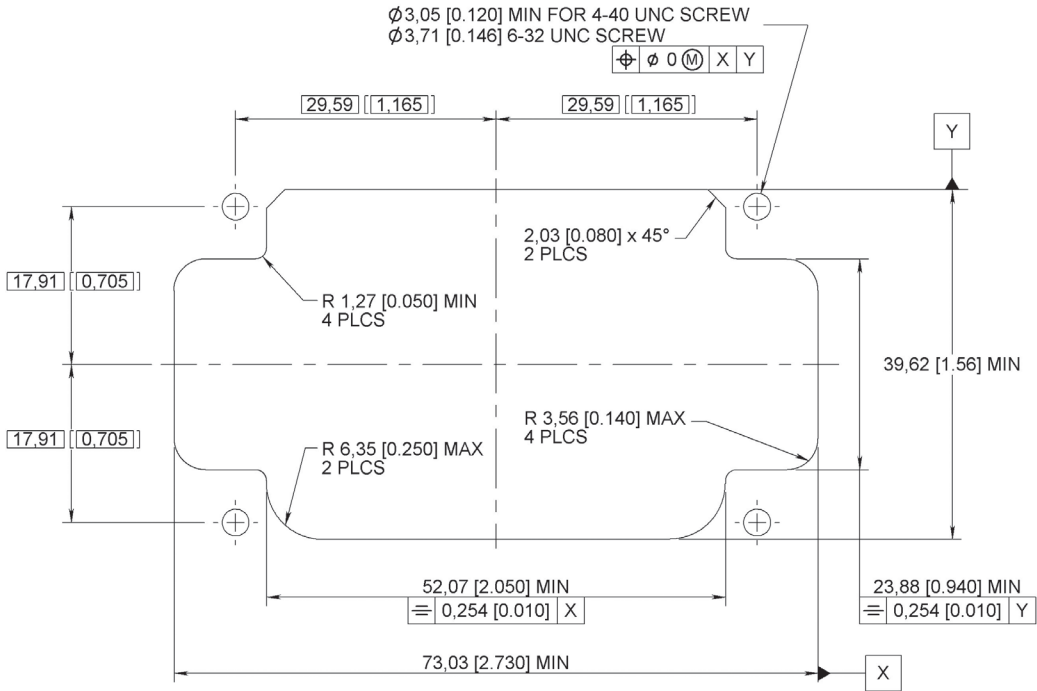

PLUG PANEL CUT OUT

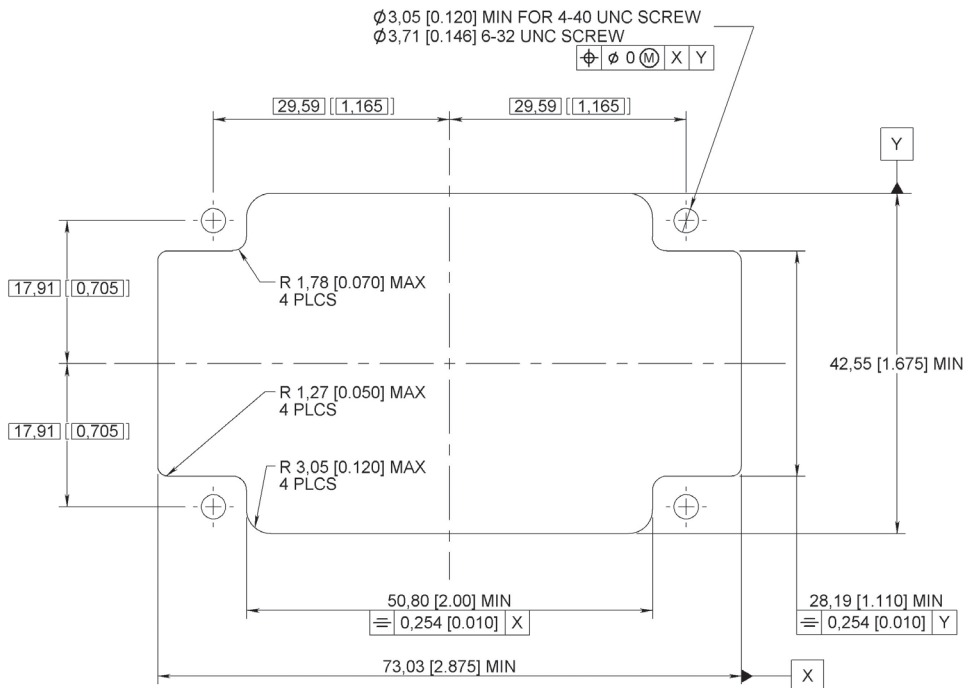

EMI/RFI NSX Single Shell Plug Dimension

HOW TO ORDER

See page 4-91

NSX SERIES

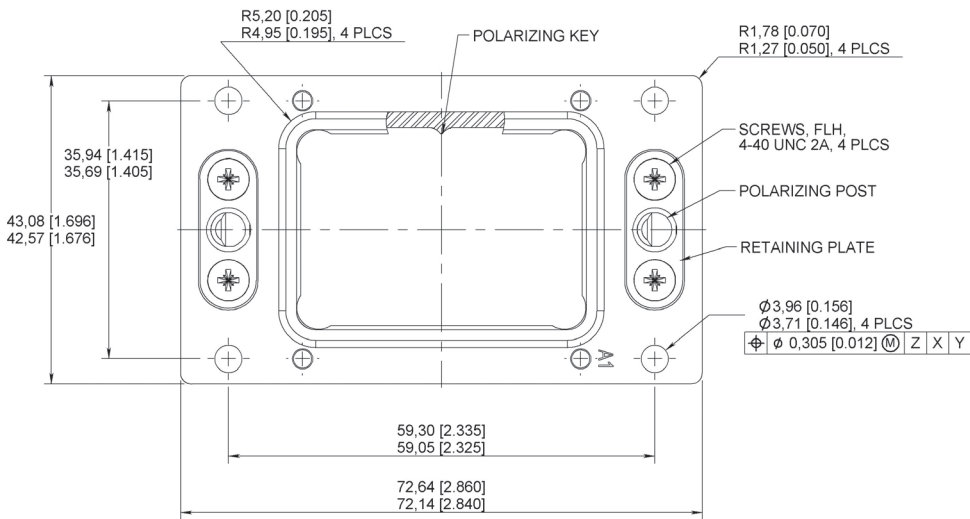
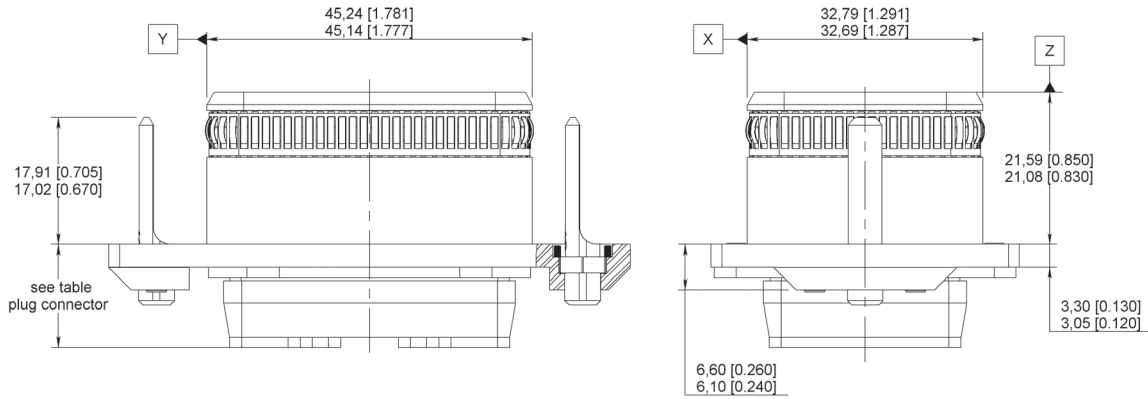

BPX Introduction

BPX series connectors are EMI shielded and modular insert concept rectangular multipin connectors fitted with NSX inserts and contacts.

BPX connectors are differentiated from NSX connectors by their shell sizes available: 1, 2 and 3.

The **BPX** characteristics are compliant to BOEING S280W551 specification. Their specific characteristics (those which are different from NSX connectors) are as follows:

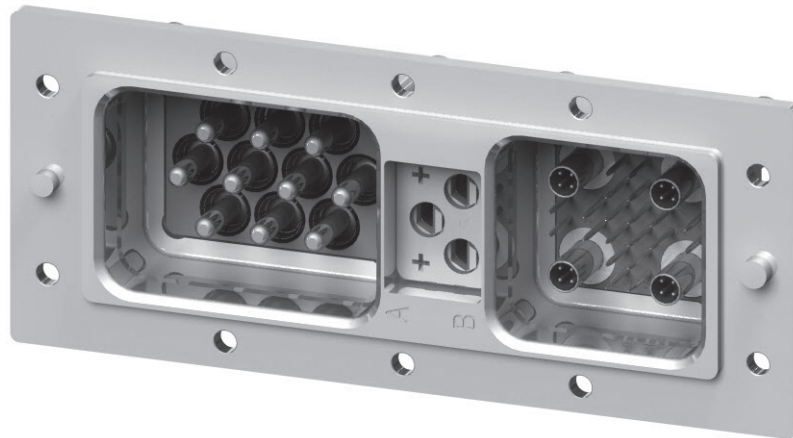

Electrical Characteristics

BPX electrical characteristics are the same as NSX connectors (see pages 4-8 to 4-9) except the following:

- Magnetic permeability: 2.0 Ohms max.

Mechanical and Environmental Characteristics

Identical to NSX connectors except the following:

Mating and unmating forces:

- Shell size 1: 70 pounds (311 N) max
- Shell size 2: 140 pounds (623 N) max
- Shell size 3: 130 pounds (578 N) max

Humidity: type II

(measured according to method 1002 of MIL-STD-1344A)

Fluid resistance: resistance to MIL-STD-1344A method 1016 (fluids a, e, i, j).

Contact stability: conforming to S280W551 requirements.

Materials

Description	Material	Plating
Shell	Aluminum alloy	Electrically conductive finish over nickel
Grounding spring fingers	Copper alloy	Nickel
Insert retention plate	Aluminum alloy	Nickel
Polarization posts and keys retention plate	Aluminum alloy	Nickel
Screws, washers and clinch nuts	Stainless steel	
Polarization posts and keys	Zinc alloy	Nickel

How to Order Connector

BPX N/E/F/G CONNECTORS FOR REAR REMOVABLE CONTACTS

BPX	E	2	P	201	S	00	01
-----	---	---	---	-----	---	----	----

Series _____

Class _____

N: Non environmental
E: Environmental
F: Non environmental receptacle connectors only for F class receptacle, only size 22 contacts can be delivered in PC Tail version, others contacts (size 20, 16, 12) will be delivered in crimp version. Coaxial, twinax and quadrax contacts shall to be ordered separately.
G: Non environmental receptacle connectors only for G class receptacle, every contacts can be delivered in PC Tail or crimp version except size 1 that will be delivered in crimp version only. Coax, twinax and power contacts size shall be ordered separately.

Shell size _____

1: 2 cavities
2: 4 cavities
3: 5 cavities

Shell style _____

R: Receptacle
P: Plug

Insert combination code _____
 See insert combination codes on page 4-100

Contacts termination ⁽¹⁾ _____

Without contacts
X: Without contacts
S: Crimp contacts

Wire wrap
K: Wire wrap contact, 1 level (1 = .272)
V: Wire wrap contact, 2 levels (1 = .390)

PC tail contacts

RoHs	Gold	Pre-tinned	Length (inch)
RA	YA	ZA	.150
R	Y	Z	.250

Modification code _____

00: Only modification code 00 is available, see page 4-29

Polarization code ⁽¹⁾ _____
 See pages 4-31 to 4-33
 Without code: polarization hardware is delivered unassembled

NOTE:
 (1) Polarization code 00, the connector is delivered without polarization hardware. Polarization code 01 to 216, the connector is delivered with the polarization hardware as defined by the code

Insert Combination Code in the Shell

Code	Insert combination on shell				
	A	B	C	D	E
101	10T10	34	/	/	/
102	10T10	59	/	/	/
103	150	13C2	/	/	/
201	150	100	150	6T6	/
202	121	6T6	150	6T6	/
203	10T10	100	10T10	100	/
204	121	6T6	121	6T6	/
205	110	6T6	150	6T6	/
301	10T10	4	6P6	60A	4
302	10T10	30T2	6P6	60A	30T2
303	120T2	4	6P6	60A	4

Contact

BPX connectors use NSX signal, power coaxial and concentric twinax contacts (see pages 4-34 to 4-57).

Accessories - Sealing Boot

The sealing boots are designed to slide down over the back of crimped contacts after they have been installed in the connector. The assembly provides bend support and moisture sealing to the contact/cable assembly. For BPX connectors size, 8 coaxial and concentric twinax contacts must be fitted with the sealing boot required by S280W552 specification.

	Wire dia mm (inch)	Wire type	Part number	Figure
Sealing boot for cavity insert size 8	3.68 [0.145]	Tensolite (S280W502-1)	619960005	

Accessories - Dust Caps

Dust caps are made of thermoplastic material, they are either conductive (black color) or non-conductive (red color).

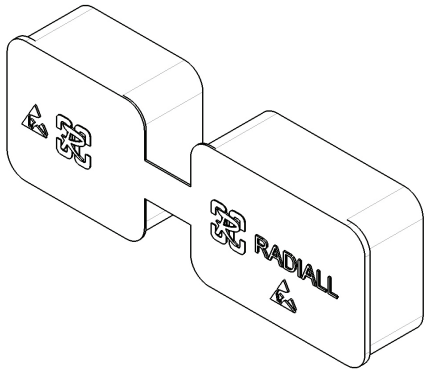
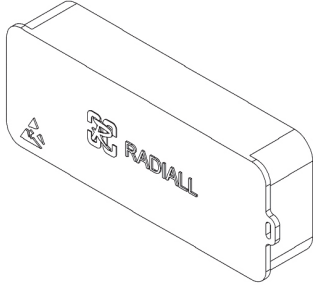
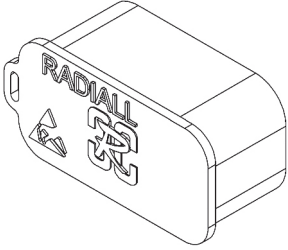
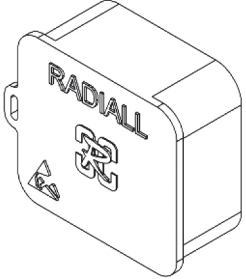
Type	Shell type	Shell size	Cavity	Part number	Figure
Conductive	Plug	1	A and B	618953002	
		2	A and B C and D		
		3	A, D	620995007	
			B, E	620995004	
		C	620995008		

Accessories - Dust Caps

BPX SERIES

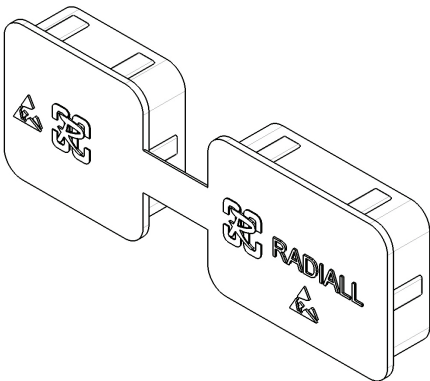
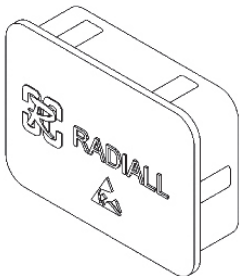
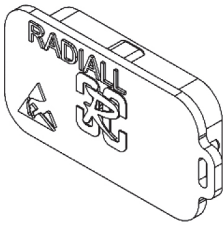
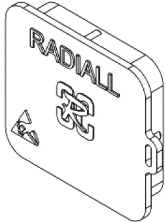
Type	Shell type	Shell size	Cavity	Part number	Figure
Conductive	Receptacle	1	A and B	618953001	
		2	A and B C and D		
		3	A, D	620995018	
			B, E	620995012	
			C	620995016	

BPX SERIES

Accessories - Dust Caps

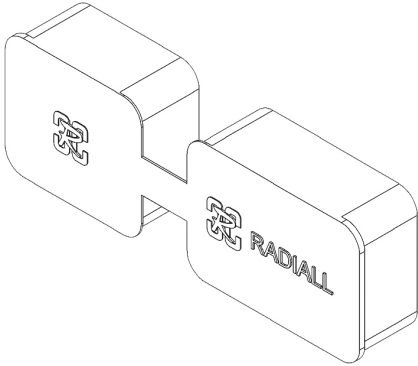
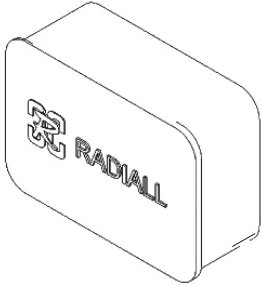
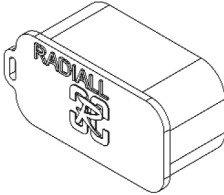
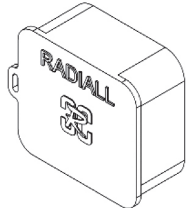
Type	Shell type	Shell size	Cavity	Part number	Figure
Non conductive	Plug	1	A and B	618953	
		2	A and B C and D		
			A, D	620995017	
			B, E	620995002	
			C	620995006	

Dimensions

SIZE 1 PLUG DIMENSIONS

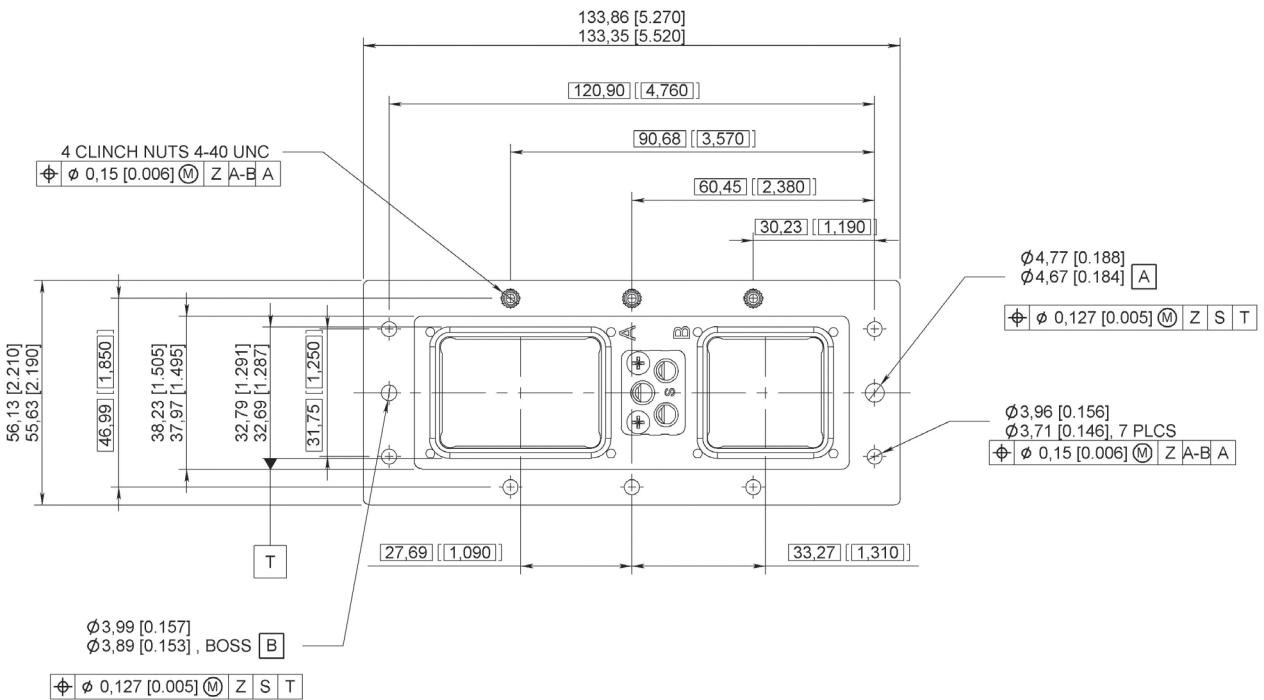
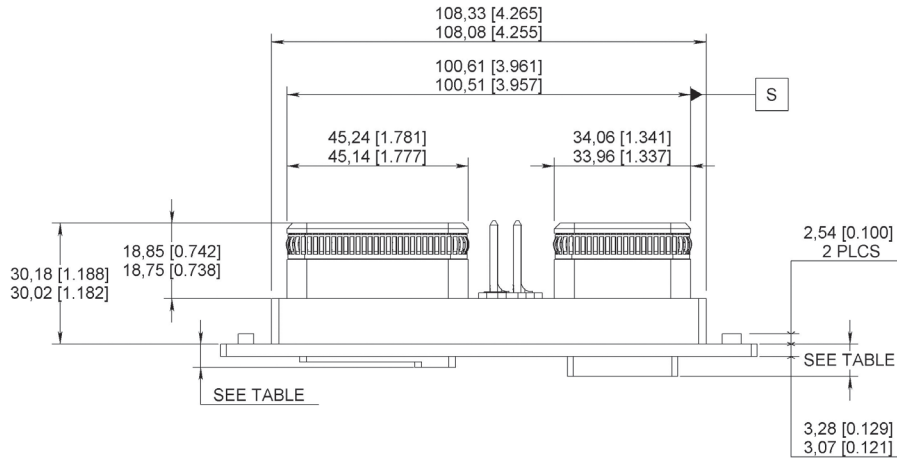

BPX SERIES

Dimensions

SIZE 2 PLUG DIMENSIONS

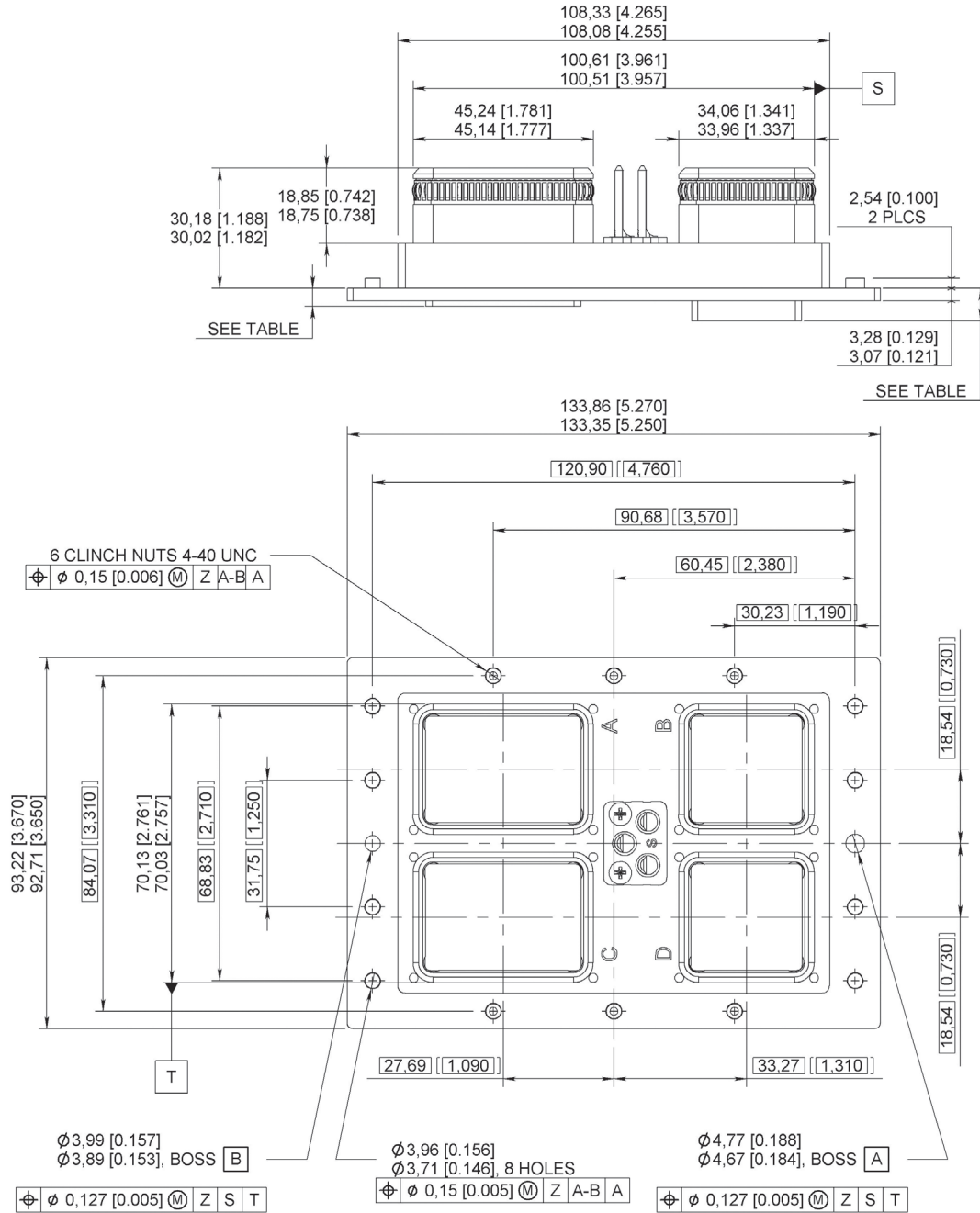

Dimensions

SIZE 3 PLUG DIMENSIONS

BPX SERIES

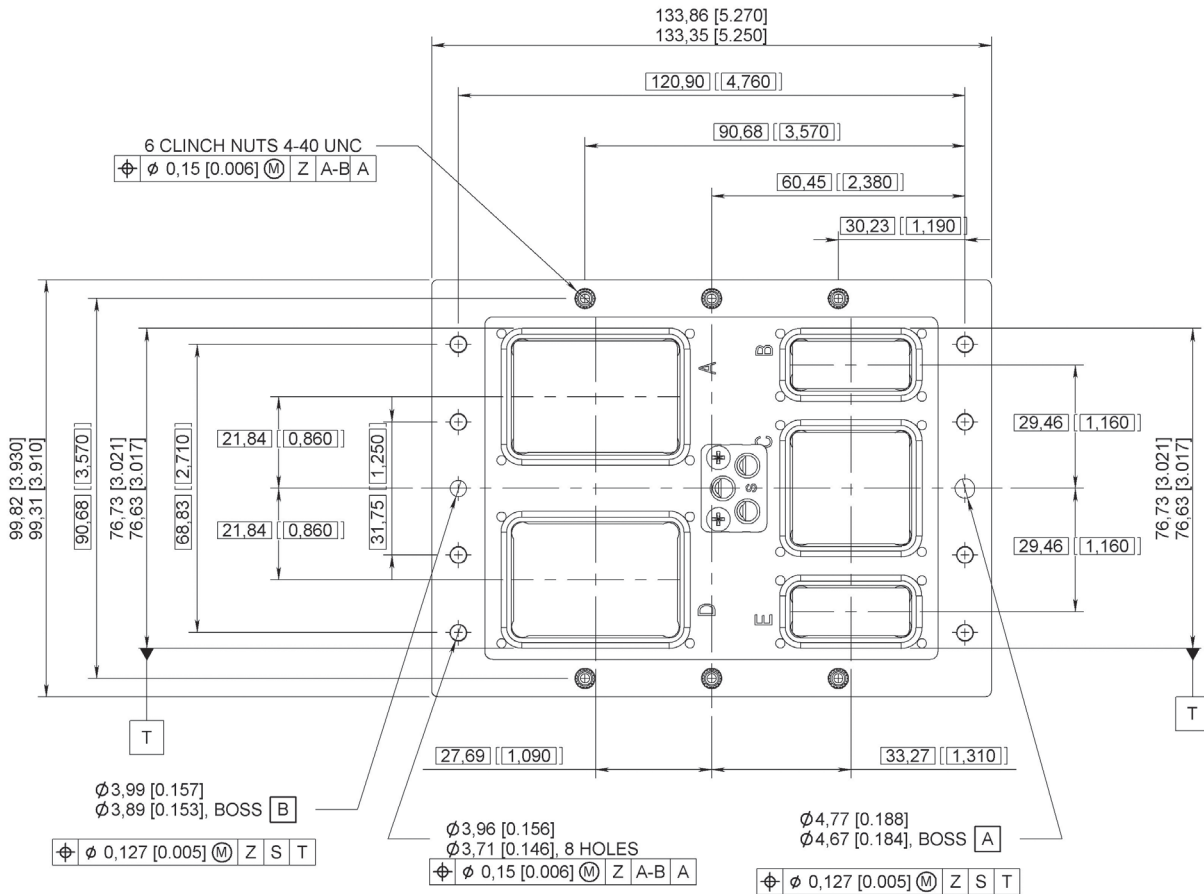
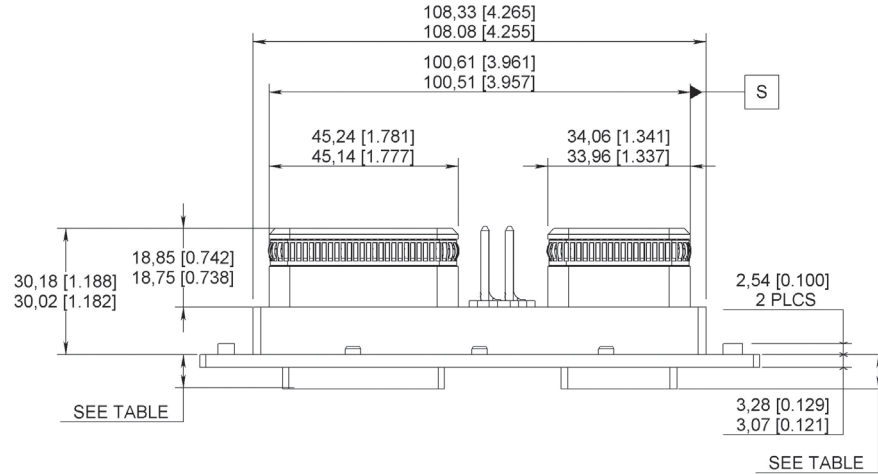

Dimensions

SIZE 1 RECEPTACLE DIMENSIONS

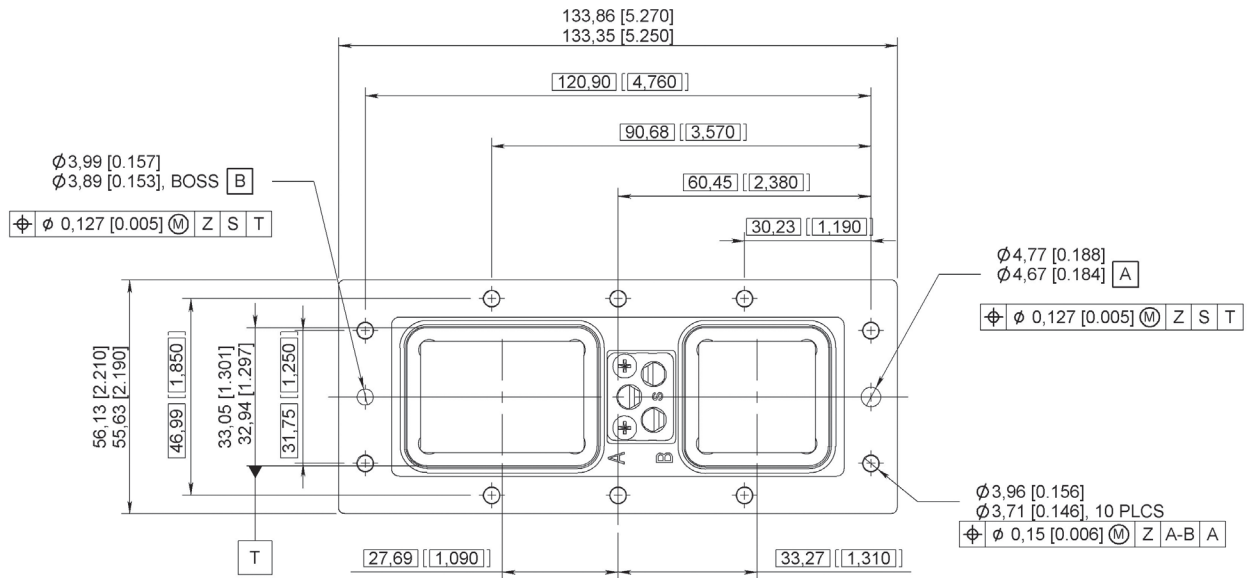
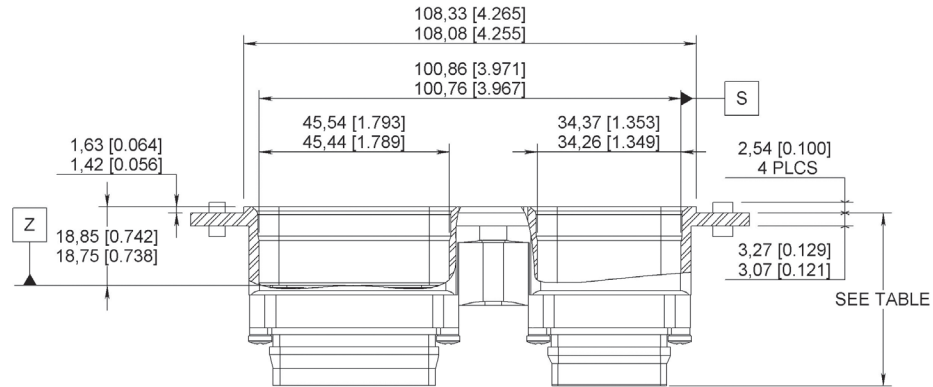

Dimensions

SIZE 2 RECEPTACLE DIMENSIONS

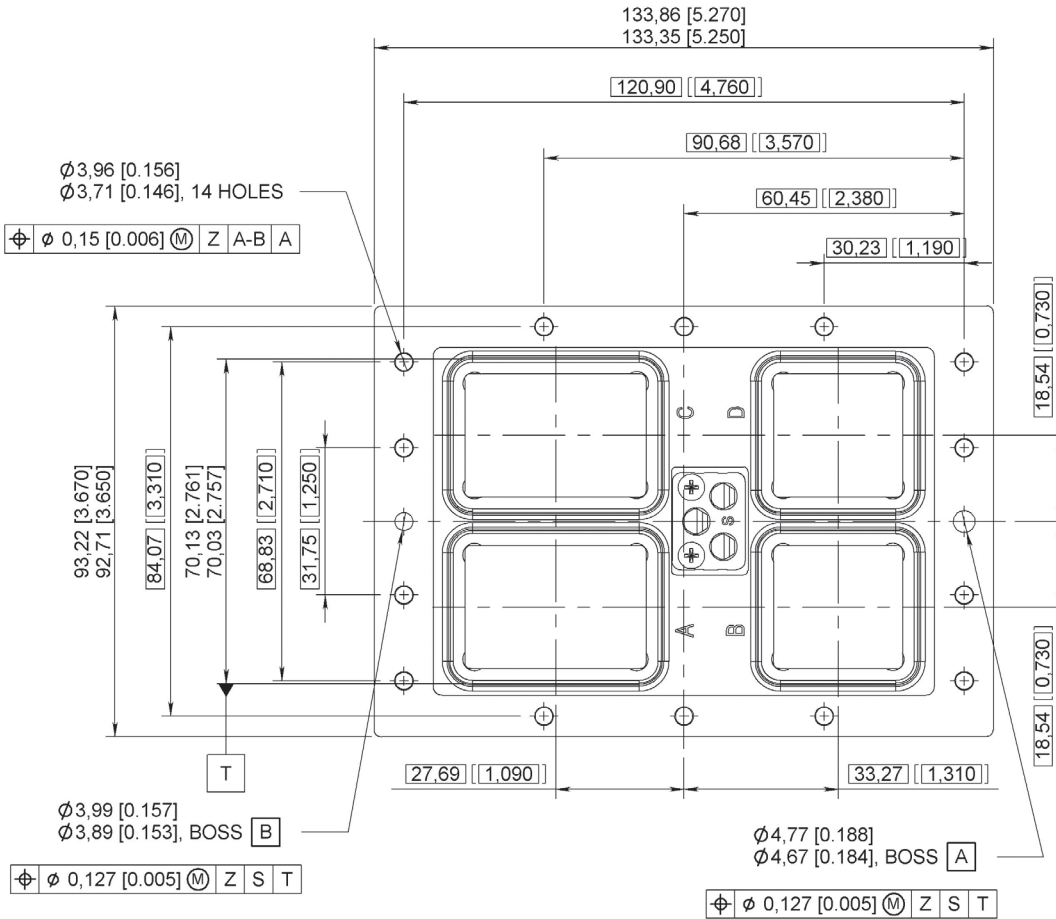
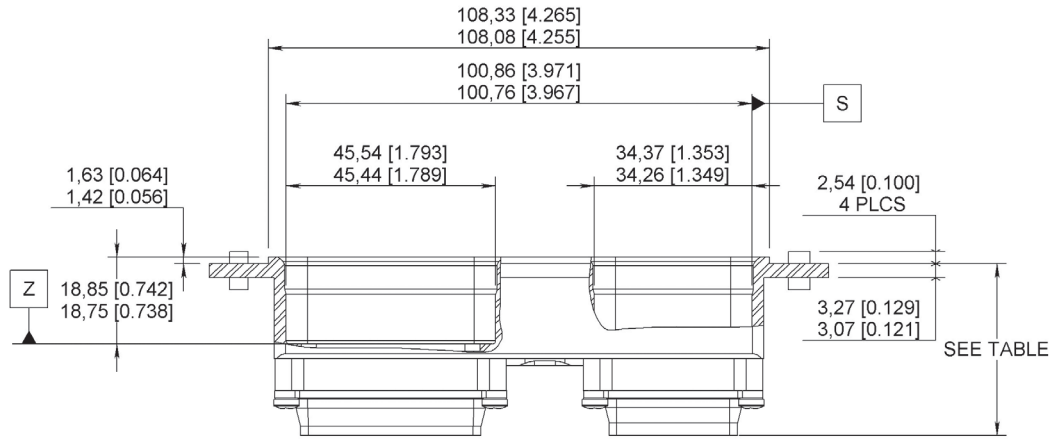

BPX SERIES

Dimensions

SIZE 3 RECEPTACLE DIMENSIONS

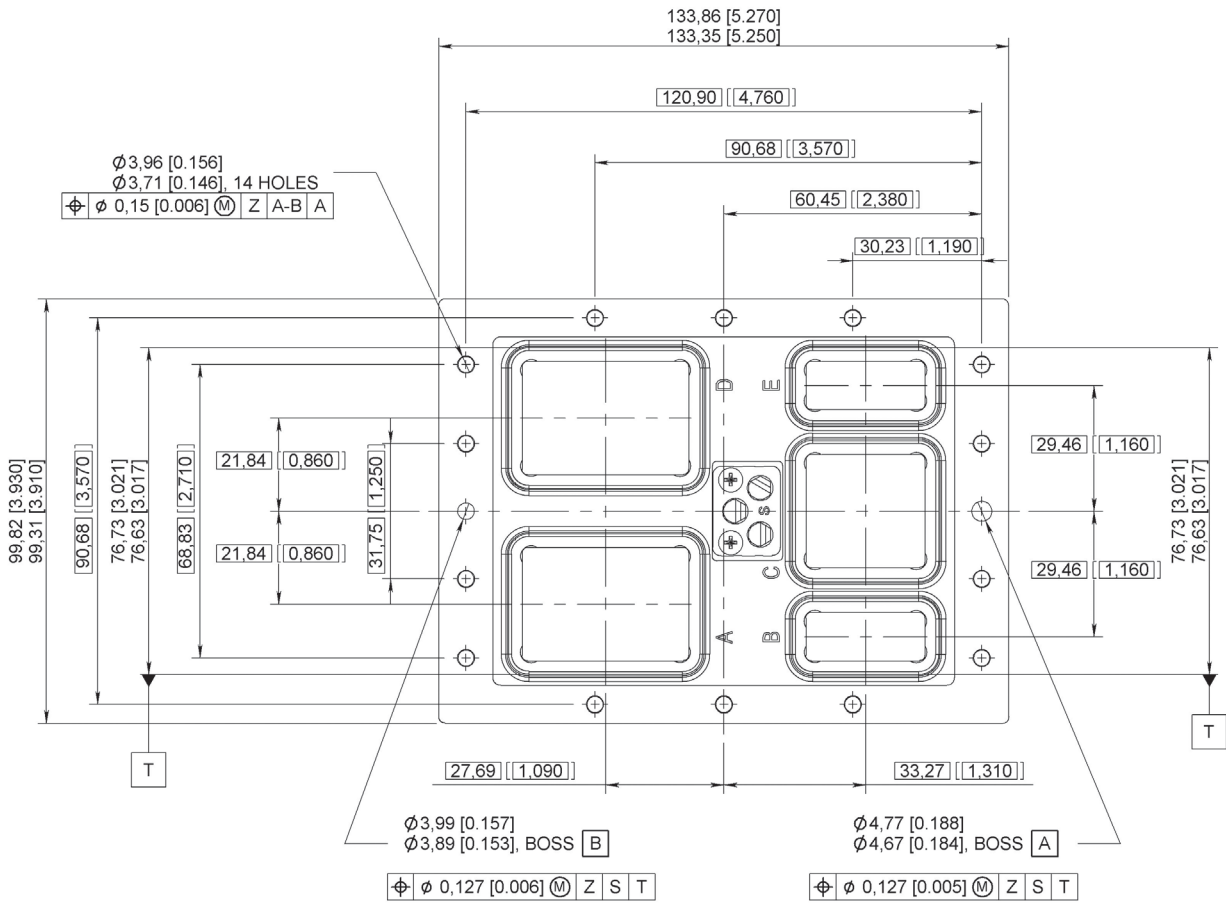
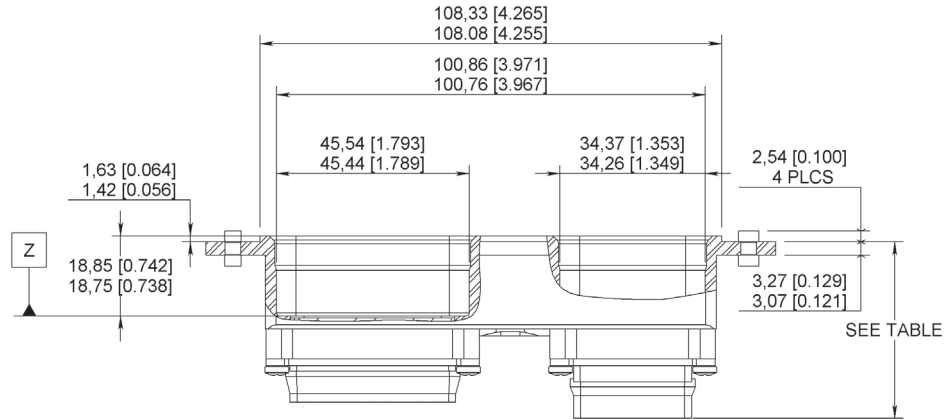

Panel Cut Out for Plug

BPX SERIES

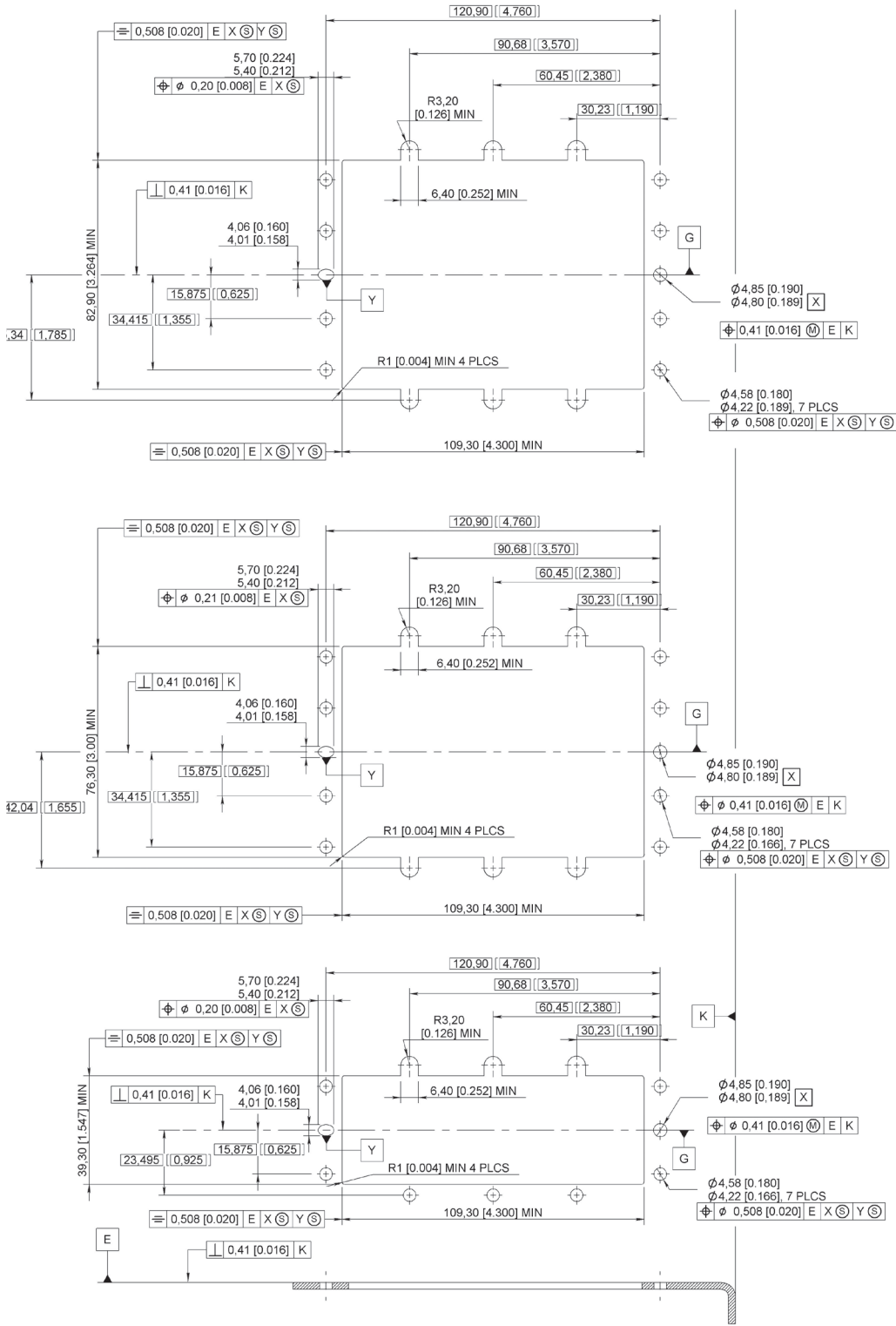

BPX SERIES

Panel Cut Out for Receptacle

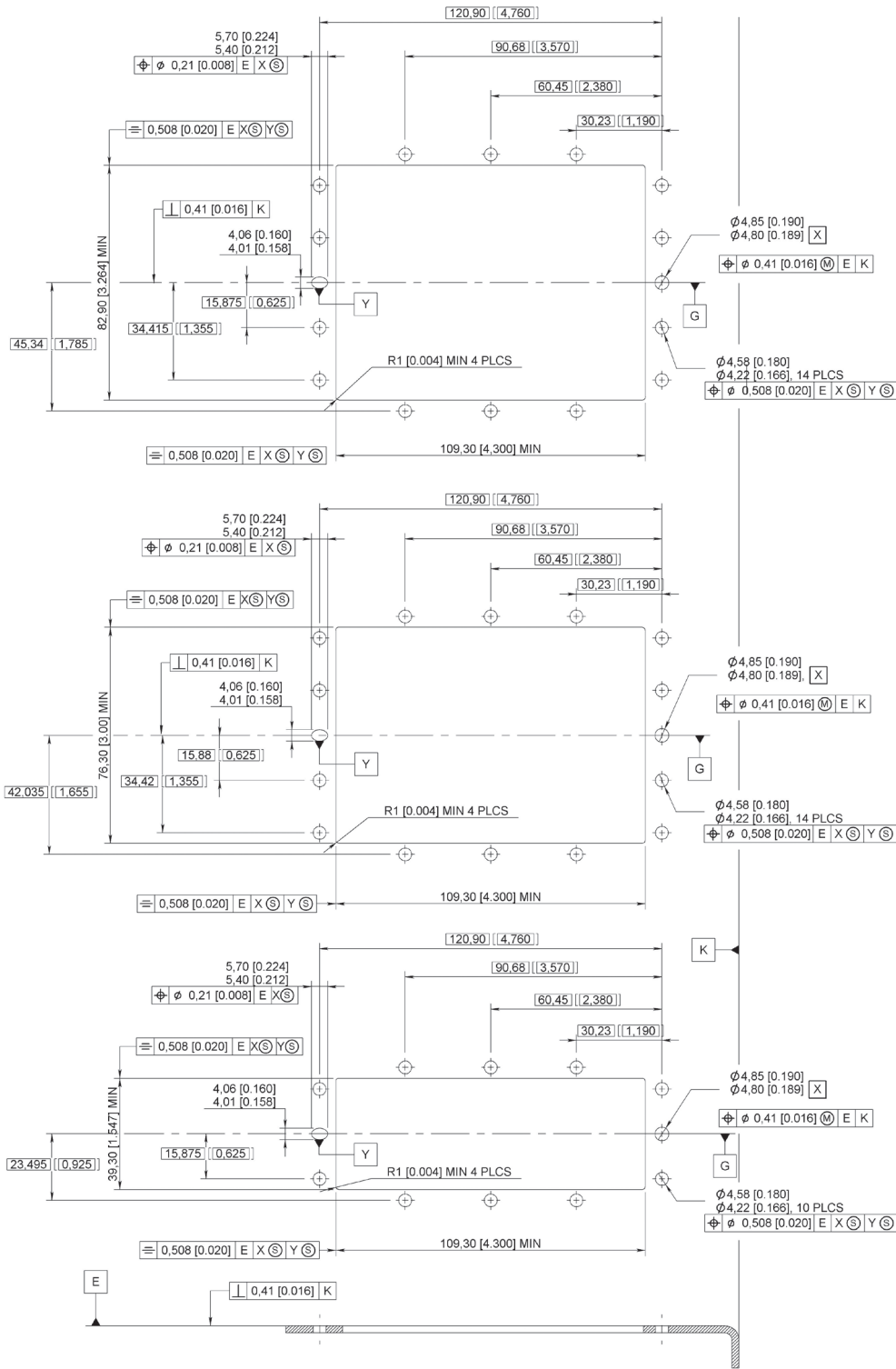



Our most
important
connection
is with you.™

It's not just a slogan. It's a statement of our earnest desire to put you at the forefront of all our business practices. As part of Radiall's mission to be available and accessible, we make it a priority to have local offices around the globe ready and able to assist you – wherever you are, whenever you need us.

Europe

	ADDRESS	PHONE	FAX	EMAIL
FINLAND	Radiall Finland PO Box 202 - 90101 Oulu	+358 407522412		infofi@radiall.com
FRANCE	Radiall SA 101 Rue Philibert Hoffmann 93116 Rosny Sous Bois	+33 1 49 35 35 35	+33 1 49 35 35 14	infofr@radiall.com
GERMANY	Radiall GmbH Carl Zeiss Str. 10 Postfach 200143 D63307 Rödermark	+49 60 74 91 07 0	+49 60 74 91 07 70	infode@radiall.com
ITALY	Radiall Elettronica S.R.L Via della Resistenza 113 - 20090 Buccinasco Milano	+39 02 48 85 121	+39 02 48 84 30 18	infoit@radiall.com
NETHERLANDS	Radiall Nederland BV Hogebrinkerweg 15b - 3871 KM Hoevelaken	+31 33 253 40 09	+31 33 253 45 12	infofl@radiall.com
SWEDEN	Radiall AB Sjöängsvägen 2 - SE - 192 72 Sollentuna	+46 8 444 34 10	+46 8 754 49 16	infose@radiall.com
UNITED KINGDOM	Radiall Ltd Ground Floor 6 The Grand Union Office Park Packet Boat Lane UXBRIDGE Middlesex UB8 2GH United Kingdom	+44 (0)1895 425000	+44 (0)1895 425010	infouk@radiall.com

Asia

	ADDRESS	PHONE	FAX	EMAIL
CHINA	Shanghai Radiall Electronics CO, Ltd N° 390 Yong He Rd SHANGHAI 200072 P.R.C	+86 21 66523788	+86 21 66521177	infozh@radiall.com
HONG KONG	Radiall Electronics (Asia) Ltd Flat D, 6/F, Ford Glory Plaza, 37-39 Wing Hong Street - Cheung Sha Wan - Kowloon - Hong Kong	+852 29593833	+852 29592636	infohk@radiall.com
INDIA	Radiall India Pvt. Ltd 25.D.II phase Peenya Industrial Area. Bangalore-560058	+91 80 23720989	+91 80 28397228	infoin@radiall.com
JAPAN	Nihon Radiall Shibuya-Ku Ebisu 1-5-2, Kougetsu Bldg 405 - Tokyo 150-0013	+81 3 34406241	+81 3 34406242	infojp@radiall.com

Americas

	ADDRESS	PHONE	FAX	EMAIL
USA & CANADA	Radiall USA, Inc. 8950 South 52nd Street Ste 401 Tempe, AZ 85284	+1 480-682-9400	+1 480-682-9403	infousa@radiall.com

Also Represented In...

AUSTRALIA AUSTRIA BELGIUM BRAZIL CZECH REPUBLIC DENMARK ESTONIA GREECE HUNGARY INDONESIA ISRAEL KOREA LATVIA LITHUANIA
MALAYSIA NORWAY PHILIPPINES POLAND PORTUGAL RUSSIA SINGAPORE SPAIN SWITZERLAND TAIWAN THAILAND VIETNAM SOUTH AFRICA