

Coaxial Amplifier

ZX60-2514MA+

50Ω High Isolation 0.5 to 2.5 GHz

Features

- from 2.8V to 5V operation
- wide bandwidth, 0.5 to 2.5 GHz
- high active directivity
- output power, up to 19 dBm typ.
- protected by US patent 6,790,049

Applications

- buffer amplifier
- LO amplifiers for mixers
- cellular
- PCN



CASE STYLE: GC957

Connectors	Model
SMA	ZX60-2514M-S+

+RoHS Compliant

The +Suffix identifies RoHS Compliance. See our web site for RoHS Compliance methodologies and qualifications

Electrical Specifications $T_{AMB}=25^{\circ}\text{C}$

MODEL NO.	FREQ. (GHz)		DC VOLTS (V)	GAIN, dB Typical					MAXIMUM POWER (dBm)		DYNAMIC RANGE			VSWR* (:1) Typ.		ACTIVE DIRECTIVITY (dB) (Isolation-Gain) Typ.		DC OPERATING CURRENT @ Pin V+ (mA)			
	f_L	f_U		over frequency, GHz					f_L	f_U	NF (dB) Typ.	IP3 (dBm) Typ.	at 1 GHz	at 1 GHz	at 2 GHz	In	Out	f_L	f_U	Typ	Max.
	0.5	2.5		16.2	17.9	18.1	17.8	16.8	15.0	19.0	17.0	4.3	31.0	29.0	1.4	1.4	32	19	75	94	
ZX60-2514MA+	0.5	2.5	5.0 2.8	14.6	15.7	15.6	15.0	14.1	—	11.0	12.0	4.5	23.5	23.5	1.4	1.5	35	20	71	—	

* at 1100-2500 MHz

Maximum Ratings

Operating Temperature	-40°C to 85°C case
Storage Temperature	-55°C to 100°C
DC Voltage	7V
Input Power (No damage)	13 dBm (continuous operation) 24 dBm (5 minutes max.)
Power Dissipation	500mW

Permanent damage may occur if any of these limits are exceeded.

Outline Drawing

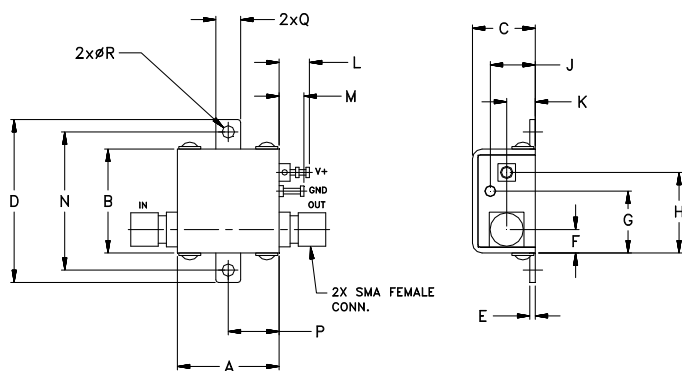

NOTE: When soldering the DC connections, caution must be used to avoid overheating the DC terminal. See Application Note. [AN-40-010](#).

Outline Dimensions (inch/mm)

A	B	C	D	E	F	G	H	J	K	L	M	N	P	Q	R	wt
.74	.75	.46	1.18	.04	.17	.45	.59	.33	.21	.22	.18	1.00	.37	.18	.106	grams
18.80	19.05	11.68	29.97	1.02	4.32	11.43	14.99	8.38	5.33	5.59	4.57	25.40	9.40	4.57	2.69	23.0

Notes

- Performance and quality attributes and conditions not expressly stated in this specification document are intended to be excluded and do not form a part of this specification document.
- Electrical specifications and performance data contained in this specification document are based on Mini-Circuit's applicable established test performance criteria and measurement instructions.
- The parts covered by this specification document are subject to Mini-Circuits standard limited warranty and terms and conditions (collectively, "Standard Terms"); Purchasers of this part are entitled to the rights and benefits contained therein. For a full statement of the Standard Terms and the exclusive rights and remedies thereunder, please visit Mini-Circuits' website at www.minicircuits.com/MCLStore/terms.jsp



www.minicircuits.com P.O. Box 350166, Brooklyn, NY 11235-0003 (718) 934-4500 sales@minicircuits.com

REV. OR
M157433
ZX60-2514MA+
RVN/TD/CP/AM
170104
Page 1 of 2

FREQUENCY (MHz)	GAIN (dB)		DIRECTIVITY (dB)		VSWR IN (:1)		VSWR OUT (:1)		POUT at 1 dB COMPR. (dBm)		NOISE FIGURE (dB)	
	2.8V	5V	2.8V	5V	2.8V	5V	2.8V	5V	2.8V	5V	2.8V	5V
500	14.69	16.27	36.41	34.01	3.18	3.34	1.55	1.50	12.07	18.93	4.95	4.87
600	15.24	16.97	34.83	34.75	2.38	2.45	1.46	1.30	12.57	19.20	4.74	4.60
700	15.53	17.37	32.23	33.64	1.96	1.99	1.43	1.18	12.60	19.43	4.62	4.53
800	15.68	17.62	29.78	30.73	1.70	1.72	1.44	1.12	12.86	19.12	4.52	4.42
900	15.77	17.79	28.02	28.73	1.53	1.53	1.46	1.09	12.66	19.29	4.48	4.39
1000	15.82	17.91	26.58	26.74	1.41	1.40	1.48	1.09	12.82	19.24	4.56	4.42
1100	15.84	18.01	25.61	25.37	1.32	1.31	1.51	1.12	12.99	18.84	4.44	4.34
1300	15.81	18.11	24.00	23.24	1.20	1.17	1.55	1.17	12.93	18.92	4.50	4.38
1500	15.71	18.13	22.66	21.90	1.12	1.09	1.59	1.23	12.93	18.71	4.46	4.37
1600	15.63	18.11	22.19	21.24	1.09	1.07	1.61	1.26	13.01	18.26	4.45	4.34
1800	15.42	17.98	21.38	20.35	1.06	1.04	1.64	1.31	13.06	17.91	4.47	4.38
2000	15.14	17.76	20.76	19.75	1.05	1.03	1.67	1.36	12.92	17.62	4.45	4.30
2200	14.79	17.43	20.51	19.62	1.06	1.02	1.69	1.40	12.96	17.19	4.44	4.27
2400	14.38	16.99	20.23	19.44	1.07	1.01	1.70	1.42	12.74	17.02	4.49	4.35
2500	14.16	16.74	20.21	19.33	1.09	1.02	1.70	1.43	12.87	16.84	4.53	4.38

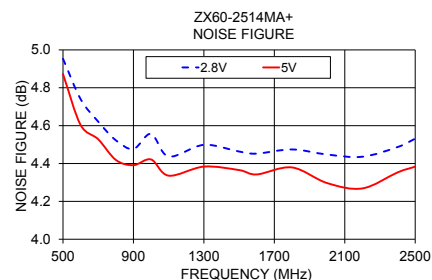
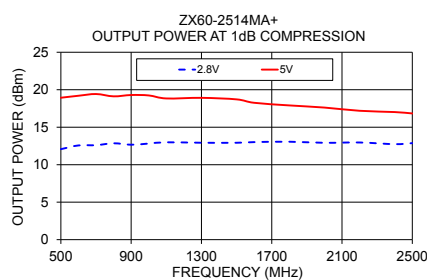
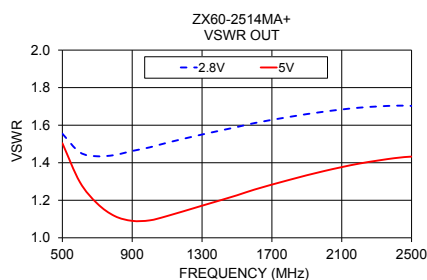
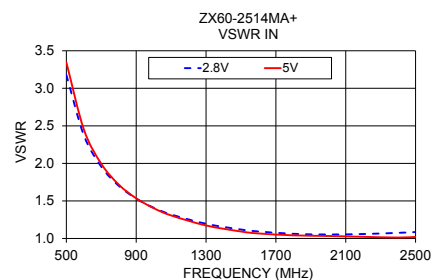
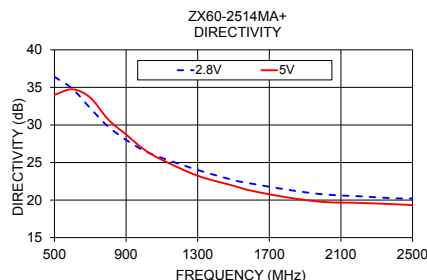
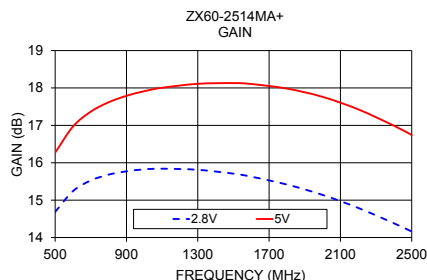

Notes

- A. Performance and quality attributes and conditions not expressly stated in this specification document are intended to be excluded and do not form a part of this specification document.
- B. Electrical specifications and performance data contained in this specification document are based on Mini-Circuit's applicable established test performance criteria and measurement instructions.
- C. The parts covered by this specification document are subject to Mini-Circuits standard limited warranty and terms and conditions (collectively, "Standard Terms"); Purchasers of this part are entitled to the rights and benefits contained therein. For a full statement of the Standard Terms and the exclusive rights and remedies thereunder, please visit Mini-Circuits' website at www.minicircuits.com/MCLStore/terms.jsp

