

Coaxial

# Amplifier

# NON-CATALOG

## ZX60-2522M+

50Ω High Isolation 0.5 to 2.5 GHz



CASE STYLE: GC957

Connectors	Model
SMA	ZX60-2522M-S+

**+RoHS Compliant**

The +Suffix identifies RoHS Compliance. See our web site for RoHS Compliance methodologies and qualifications

### Features

- from 2.8V to 5V operation
- wide bandwidth, 0.5 to 2.5 GHz
- high active directivity, 20 dB typ.
- output power, up to 18.0 dBm typ.
- protected by US patent 6,790,049

### Applications

- buffer amplifier
- LO amplifiers for mixers
- cellular
- PCN

### Electrical Specifications T<sub>AMB</sub>=25°C

MODEL NO.	FREQ. (GHz)		DC VOLTS (V)	GAIN, dB Typical						MAXIMUM POWER (dBm)			DYNAMIC RANGE			VSWR (:1) Typ.		ACTIVE DIRECTIVITY (dB) (Isolation-Gain) Typ	DC OPERATING CURRENT @ Pin V+ (mA)			
	f <sub>L</sub>	f <sub>U</sub>		over frequency, GHz						Output (1 dB Comp.) Typ.		Input (no damage)	NF (dB) Typ.	IP3 (dBm) Typ.	at 1 GHz	at 2 GHz	In		Out	Typ	Typ	Max.
				0.5	1.0	1.5	2.0	2.5	Min. at 2 GHz	f <sub>L</sub>	f <sub>U</sub>											
ZX60-2522M+	0.5	2.5	5.0	18.7	22.5	23.5	23.3	21.7	21.5	18.0	15.8	10	3.0	30.6	28.8	1.5	1.7	17	86	95		
			2.8	17.2	20.2	20.6	20.6	20.0	—	14.4	14.2	10	3.0	25.7	25.6	1.4	1.8	20	80	—		

### Maximum Ratings

Operating Temperature	-40°C to 85°C case
Storage Temperature	-55°C to 100°C
DC Voltage	7V
Input Power(no damage)	10 dBm
Power	500mW

Permanent damage may occur if any of these limits are exceeded.

### Outline Drawing

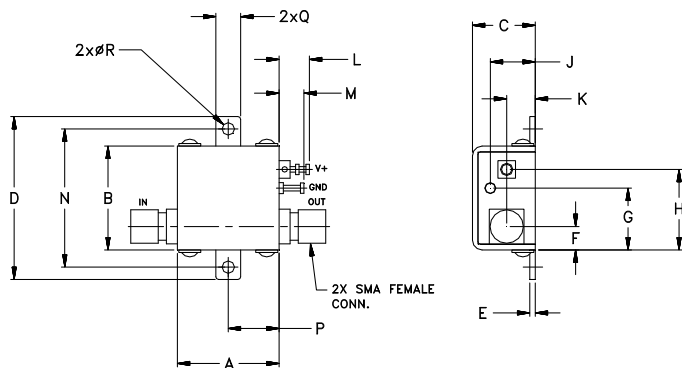

**!** NOTE: When soldering the DC connections, caution must be used to avoid overheating the DC terminal. See Application Note. [AN-40-010](#).

### Outline Dimensions (inch/mm)

A	B	C	D	E	F	G	H	J	K	L	M	N	P	Q	R	wt
.74	.75	.46	1.18	.04	.17	.45	.59	.33	.21	.22	.18	1.00	.37	.18	.106	grams
18.80	19.05	11.68	29.97	1.02	4.32	11.43	14.99	8.38	5.33	5.59	4.57	25.40	9.40	4.57	2.69	23.0

### Notes

- Performance and quality attributes and conditions not expressly stated in this specification document are intended to be excluded and do not form a part of this specification document.
- Electrical specifications and performance data contained in this specification document are based on Mini-Circuit's applicable established test performance criteria and measurement instructions.
- The parts covered by this specification document are subject to Mini-Circuits standard limited warranty and terms and conditions (collectively, "Standard Terms"); Purchasers of this part are entitled to the rights and benefits contained therein. For a full statement of the Standard Terms and the exclusive rights and remedies thereunder, please visit Mini-Circuits' website at [www.minicircuits.com/MCLStore/terms.jsp](http://www.minicircuits.com/MCLStore/terms.jsp)



[www.minicircuits.com](http://www.minicircuits.com) P.O. Box 350166, Brooklyn, NY 11235-0003 (718) 934-4500 sales@minicircuits.com

REV. E  
M160892  
ZX60-2522M+  
EDR-6127  
RVN/TD/CP/AM  
170406  
Page 1 of 2

# NON-CATALOG

## Typical Performance Data/Curves

## ZX60-2522M+

FREQUENCY (MHz)	GAIN (dB)		DIRECTIVITY (dB)		VSWR IN (:1)		VSWR OUT (:1)		NOISE FIGURE (dB)		POUT at 1 dB COMPR. (dBm)	
	2.8V	5V	2.8V	5V	2.8V	5V	2.8V	5V	2.8V	5V	2.8V	5V
500.00	17.44	18.83	27.10	23.74	2.59	2.48	2.12	2.09	3.37	3.29	14.88	19.61
700.00	19.46	21.26	23.93	21.85	1.82	1.70	1.47	1.38	3.07	2.99	15.20	19.78
1000.00	20.37	22.64	20.23	19.23	1.34	1.20	1.45	1.12	2.90	2.86	15.47	19.55
1200.00	20.69	23.17	18.98	18.22	1.21	1.13	1.60	1.26	2.96	2.89	15.25	19.01
1500.00	20.87	23.68	17.04	15.87	1.12	1.17	1.85	1.49	3.02	2.95	15.13	18.55
1700.00	20.84	23.71	16.06	16.05	1.08	1.15	1.99	1.65	3.04	2.98	14.78	18.03
2000.00	20.78	23.45	15.45	15.60	1.08	1.07	2.15	1.80	3.17	3.06	14.72	17.75
2200.00	20.17	22.62	15.71	16.17	1.17	1.14	2.23	1.83	3.25	3.14	14.91	17.43
2300.00	20.05	22.29	15.00	15.51	1.24	1.21	2.25	1.83	3.21	3.08	15.00	17.27
2500.00	19.40	21.29	15.46	16.36	1.39	1.38	2.26	1.80	3.30	3.15	15.02	17.38

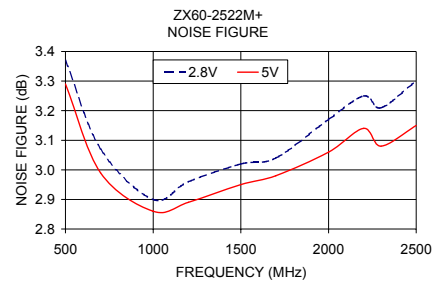
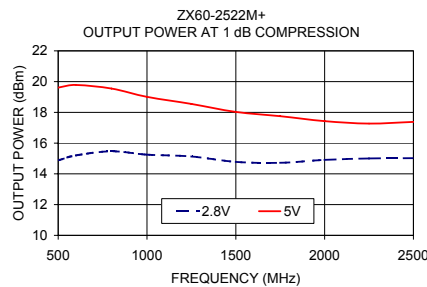
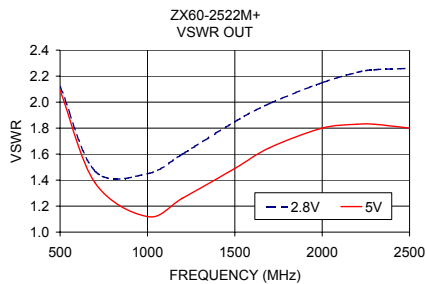
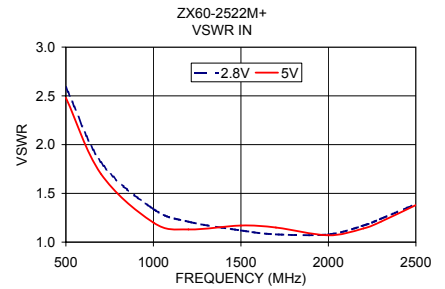
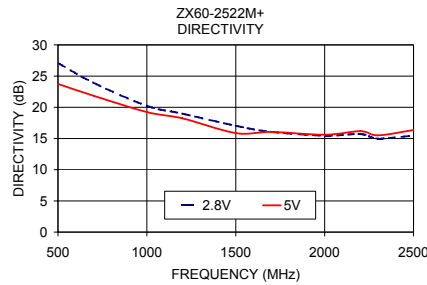
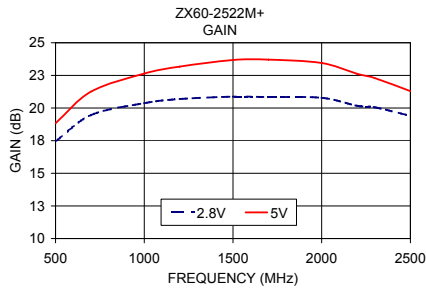

### Notes

- Performance and quality attributes and conditions not expressly stated in this specification document are intended to be excluded and do not form a part of this specification document.
- Electrical specifications and performance data contained in this specification document are based on Mini-Circuit's applicable established test performance criteria and measurement instructions.
- The parts covered by this specification document are subject to Mini-Circuits standard limited warranty and terms and conditions (collectively, "Standard Terms"); Purchasers of this part are entitled to the rights and benefits contained therein. For a full statement of the Standard Terms and the exclusive rights and remedies thereunder, please visit Mini-Circuits' website at [www.minicircuits.com/MCLStore/terms.jsp](http://www.minicircuits.com/MCLStore/terms.jsp)

