

Plastic-Probe Unwired Contact Removal Tools (M81969/30)

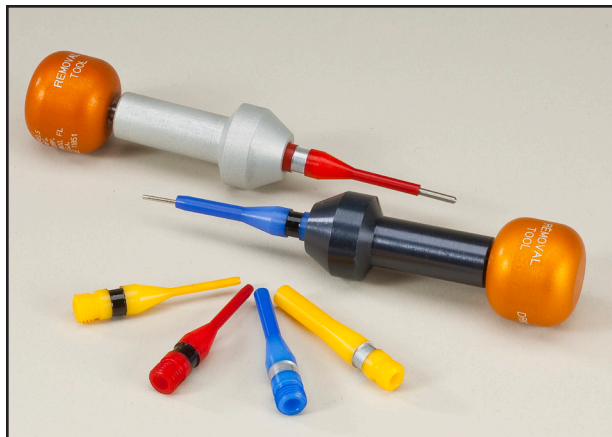

Unwired contacts are often present in aerospace wiring systems. It is very important not to damage the interfacial seal and/or connector insert when removing an unwired contact. Front Release unwired contacts do not require a special tool; they are removed with the standard tool. Rear Release unwired contacts are a problem, because the wire is not present to grip when removing the contact.

The M81969/30 series Plastic-Probe tools are designed for removing unwired contacts from rear release connectors. The flexible plastic tip goes over the contact wire barrel, releases the locking mechanism from the connector, and grips the contact until extraction is complete. The contact can then be ejected from the tool probe with a plunger designed for this purpose. Each handle is designated for a specific connector series or grouping and is supplied with multiple plastic probes. Color bands on the probe indicates the handle association, and keeps the probes in sets.

Plastic Probe Tools are widely used in Maintenance Operations, but the plastic probes can be damaged when used to remove contacts with broken wires. A durable metal probe tool is available for removing unwired contacts of broken wire contacts.

PLASTIC-PROBE UNWIRED CONTACT REMOVAL TOOLS						
DMC Tool P/N*	Connector Series	Probe Part Number	Probe Size	Probe Color	Probe Band Color	MIL Part Number (1 Handle w/ 1 Probe)
DRK50	AS50151 Series MS3450	DRK50-16-2	16	Blue	Green	--
		DRK50-12-2	12	Yellow	Green	--
DRK105	MIL-PRF-38999, Series 1 - 4 MIL-DTL-24308 MIL-DTL-55302/68 MIL-DTL-55302/71 MIL-DTL-55302/75 MIL-DTL-83733, (size 22D only)	DRK105-22M-2	22D/22M	Yellow	Brown	M8169/30B-09
		DRK105-22-2	22	Green	Brown	M8169/30B-10
		DRK105-20-2	20	Red	Brown	M8169/30B-11
		DRK105-16-2	16	Blue	Brown	M8169/30B-12
		DRK105-12-2	12	Yellow	Brown	M8169/30B-13
DRK110	MIL-DTL-83733, (except size 22D) MIL-DTL-83723, Series 3 MIL-DTL-26482, Series 2 MIL-C-81511, (class "L" only)	DRK110-20-2	20	Red	Silver	M8169/30B-05
		DRK110-16-2	16	Blue	Silver	M8169/30B-06
		DRK110-12-2	12	Yellow	Silver	M8169/30B-07
DRK130	MIL-C-81511 Series 3 & 4 (except class "L")	DRK130-22-2	22	Yellow	Black	M8169/30B-01
		DRK130-20-2	20	Red	Black	M8169/30B-02
		DRK130-16-2	16	Blue	Black	M8169/30B-03
		DRK130-12-2	12	Yellow	Black	M8169/30B-04

*DMC Tool Part Number includes one tool handle and all corresponding probes.

Using Plastic-Probe Unwired Contact Removal Tools

1. Select the proper removal tool for the connector being serviced and the proper probe size for the contact needing to be removed.
2. Extend the handle to retract the plunger.
3. Remove the sealing plug and gently ease tool probe into rear of connector through the sealing grommet and into the hard dielectric until probe stops against contact shoulder.
4. At this point, the tool will release the contact from the connector retention clip, allowing contact to be removed from the connector.
5. Carefully remove tool probe and contact from rear of connector by pulling out slowly.
6. To remove contact from tool probe, simply push ball handle and plunger will eject contact.

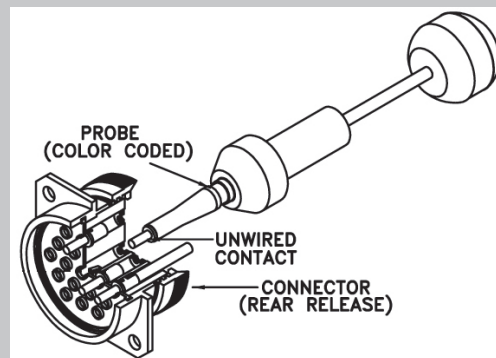

CAUTION: Do Not Tip or Rotate Tool While in Connector!!



Metal-Probe Broken Wire and Unwired Contact Removal Tools (Proprietary Design)

A common failure experience in connectors is a broken wire inside the connector, and just above the wire barrel. This is especially common in high density, small conductor applications. Plastic tip removal tools can be damaged by the strands of wire that protrude from the wire barrel.

DMC's metal tip **DRK276-xx** series of removal tools are specially engineered to remove broken wire contacts. (The "xx" number is the Contact Gage Size.) Instead of different colored probes and bands, the **DRK276** series removal tools have different colored tool bodies to help distinguish between tip sizes. These tools remove both unwired and broken wire contacts in rear release connectors.

METAL-PROBE UNWIRED CONTACT REMOVAL TOOLS			
Connector Series	Tool Part Number	Probe Size	Body Color
MIL-C-38999 Series 1 - 4	DRK276-12	12	Yellow
	DRK276-16	16	Blue
	DRK276-20	20	Red
	DRK276-22	22	Brown
	DRK276-22M	22M	Green
	DRK276-22D	22D	Black



Using Metal-Probe Unwired Contact Removal Tools

1. Select the correct removal tool based on the size of the contact being serviced.
2. Extend the handle to retract the plunger.
3. Gently ease tool into rear of connector through the sealing grommet and into the hard dielectric until tool stops against contact shoulder.
4. At this point, the tool will release the contact from the connector retention clips, allowing contact to be removed from the connector.
5. Carefully remove tool probe and contact from rear of connector by pulling out slowly.
6. To remove contact from tool probe, simply push ball handle and plunger will eject contact.

CAUTION: Do Not Tip or Rotate Tool While in Connector!!