



Part no.: 50134417
DDLS 548i 120.3
Optical data transmission



Figure can vary

Contents

- Technical data
- Dimensioned drawings
- Electrical connection
- Operation and display
- Suitable receivers
- Part number code
- Notes
- Accessories

Technical data

Basic data	
Series	DDLS 500
Special design	
Special design	Not influenced by reflective surfaces Operation of parallel light axes Remote maintenance via web server
Optical data	
Working range	100 ... 120,000 mm
Light source	Laser
Usable opening angle, transmitter	1 °
Electrical data	
Performance data	
Supply voltage U _B	18 ... 30 V , DC
Interface	
Type	PROFINET
Profinet	
Transmission speed	100 Mbit/s
Connection	
Number of connections	2 Piece(s)
Connection 1	
Type of connection	Connector
Designation on device	POWER
Thread size	M12
Type	Male
No. of pins	5 -pin
Encoding	A-coded
Connection 2	
Type of connection	Connector
Designation on device	BUS
Thread size	M12
Type	Female
No. of pins	4 -pin
Encoding	D-coded
Mechanical data	
Dimension (W x H x L)	100 mm x 156 mm x 99.5 mm
Housing material	Metal
Net weight	1,185 g
Operation and display	
Type of display	Bar graph LED

Part no.: 50134417 – DDLS 548i 120.3 – Optical data transmission

Type of configuration	GSDML file Software Via web browser
-----------------------	---

Environmental data

Ambient temperature, operation	-5 ... 50 °C
Ambient temperature, storage	-35 ... 70 °C

Certifications

Degree of protection	IP 65
Certifications	c UL US
Test procedure for EMC in accordance with standard	EN 1000-6-4 EN 61000-6-2
Test procedure for noise in accordance with standard	EN 60068-2-64
Test procedure for oscillation in accordance with standard	EN 60068-2-6
Test procedure for shock in accordance with standard	EN 60068-2-27

Classification

Customs tariff number	85365019
eCl@ss 8.0	27100990
eCl@ss 9.0	27100990

Dimensioned drawings

All dimensions in millimeters

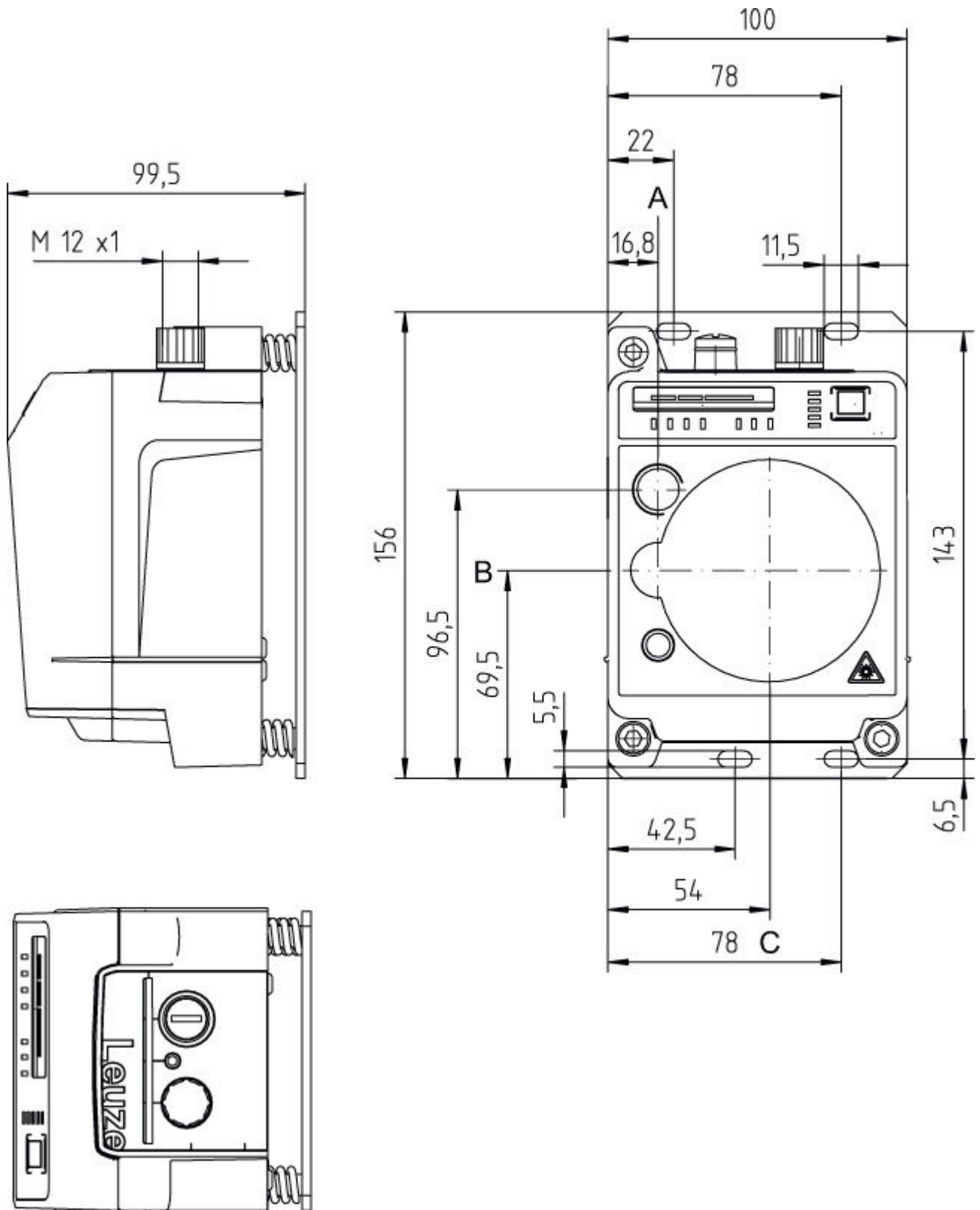

A Middleaxis Transmitter
 B Center axis of transmitter and receiver
 C Center axis of receiver

Electrical connection

Connection 1	POWER
Type of connection	Connector
Function	Signal IN Signal OUT Voltage supply
Thread size	M12
Type	Male
Material	Metal
No. of pins	5 -pin
Encoding	A-coded

Pin	Pin assignment
1	VIN
2	IO1
3	GND
4	IO2
5	FE/SHIELD

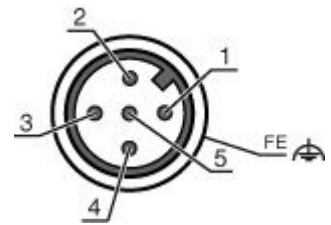

Connection 2	BUS
Type of connection	Connector
Function	BUS IN
Thread size	M12
Type	Female
Material	Metal
No. of pins	4 -pin
Encoding	D-coded

Pin	Pin assignment
1	TD+
2	RD+
3	TD-
4	RD-

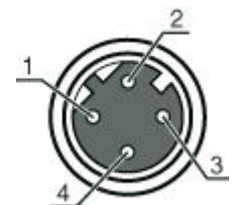

Operation and display

LEDs

LED	Display	Meaning	
1	AUT	Off	Operating mode not active
		Green, continuous light	Operating mode 'Automatic'
2	MAN	Off	Operating mode not active
		Green, continuous light	Operating mode 'Manual'
3	ADJ	Off	Operating mode not active
		Green, continuous light	Operating mode 'Adjust'
4	LAS	Off	Operating mode not active
		Green, continuous light	Operating mode 'Alignment-laser mounting support'

Part no.: 50134417 – DDLS 548i 120.3 – Optical data transmission

LED	Display	Meaning	
5	LLC	Off	Operating mode not active
		Green, continuous light	LLC without interruption
		Red, continuous light	LLC interrupted at least once
6	PWR	Off	No supply voltage
		Green, flashing	Device ok, initialization phase
		Green, continuous light	Data transmission active
		Red, flashing	Data transmission interrupted
		Red, continuous light	Device error
7	TMP	Off	Operating temperature OK
		Orange, continuous light	Operating temperature critical
		Red, continuous light	Operating temperature exceeded or not met
8	LSR	Off	With function reserve
		Orange, continuous light	Device OK, warning set
9	BUS	Off	No supply voltage
		Green, flashing	Device waiting for communication to be re-established, no data exchange
		Green, continuous light	Communication with IO-Controller established, data exchange active
		Orange, flashing	PROFINET wave function activated, the PWR and BUS LEDs flash in sync in orange
		Red, flashing	Parameterization or configuration failed, no data exchange
		Red, continuous light	Bus error, no communication established to the IO controller
10	OLK	Off	Fault
		Green, continuous light	No data transmission
		Orange, continuous light	Data transmission active
11	ERL	Off	Link OK
		Orange, continuous light	Missing link (Ethernet cable connection) on the second device
		Red, continuous light	No cable-connected link to the connected device
12	LINK	Off	No cable-connected link to the connected device
		Green, continuous light	Link OK
		Orange, continuous light	Data transmission active
13	SIGNAL QUALITY	2 red, 2 orange and 4 green	Received signal level

Suitable receivers

	Part no.	Designation	Article	Description
	50134418	DDLS 548i 120.4	Optical data transmission	Working range: 100 ... 120,000 mm Interface: PROFINET Connection: Connector, M12 Special design: Operation of parallel light axes, Not influenced by reflective surfaces, Remote maintenance via web server

Part number code

Part designation: **DDLS 5XXX YYY.Z A B CC**

DDLS	Optical transceiver for digital data transmission
5XXX	Series: 508i: without integrated web server for remote diagnostics 508i: with integrated web server for remote diagnostics 538: without integrated web server for remote diagnostics (EtherCAT) 548i: with integrated web server for remote diagnostics
YYY	Range for data transmission in m

Part no.: 50134417 – DDLS 548i 120.3 – Optical data transmission

Z	Frequency of the transmitter: 0: Frequency F0 1: Frequency F1 2: Frequency F2 3: Frequency F3 4: Frequency F4
A	Option: L: integrated laser alignment aid (for transmitter/receiver) n/a: standard
B	Special equipment: H: with heating n/a: no special equipment
CC	Special equipment: W: transmission optics with larger opening angle (on request) n/a: no special equipment

Note

A list with all available device types can be found on the Leuze electronic website at www.leuze.com.

Notes

Observe intended use!

- This product is not a safety sensor and is not intended as personnel protection.
- The product may only be put into operation by competent persons.
- Only use the product in accordance with its intended use.

For UL applications:



- For UL applications, use is only permitted in Class 2 circuits in accordance with the NEC (National Electric Code).

WARNING! INVISIBLE LASER RADIATION – LASER CLASS 1M

- **Never observe directly using telescope optics!**
The device satisfies the requirements of IEC 60825-1:2007 (EN 60825-1:2007) safety regulations for a product of **laser class 1M** as well as the U.S. 21 CFR 1040.10 regulations with deviations corresponding to "Laser Notice No. 50" from June 24, 2007.
- Looking into the beam path for extended periods using telescope optics may damage the eye's retina. Never look using telescope optics into the laser beam or in the direction of reflecting beams.
- **CAUTION!** The use of operating and adjusting devices other than those specified here or the carrying out of differing procedures may lead to dangerous exposure to radiation!
The use of optical instruments or devices (e.g., magnifying glasses, binoculars) in combination with the device increases the danger of eye damage.
- Observe the applicable statutory and local laser protection regulations.
- The device must not be tampered with and must not be changed in any way.
There are no user-serviceable parts inside the device.
Repairs must only be performed by Leuze electronic GmbH + Co. KG.

Accessories



Connection technology - Connection cables

	Part no.	Designation	Article	Description
	50132079	KD U-M12-5A-V1-050	Connection cable	Connection 1: Connector, M12, Axial, Female, A-coded, 5 -pin Connection 2: Open end Shielded: No Cable length: 5,000 mm Sheathing material: PVC
	50135074	KS ET-M12-4A-P7-050	Connection cable	Suitable for interface: Ethernet Connection 1: Connector, M12, Axial, Male, D-coded, 4 -pin Connection 2: Open end Shielded: Yes Cable length: 5,000 mm Sheathing material: PUR

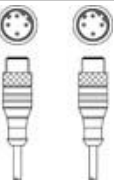
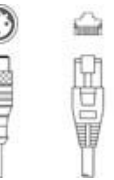

Connection technology - Interconnection cables

	Part no.	Designation	Article	Description
	50137078	KSS ET-M12-4A-M12-4A-P7-050	Interconnection cable	Suitable for interface: Ethernet Connection 1: Connector, M12, Axial, Male, D-coded, 4 -pin Connection 2: Connector, M12, Axial, Male, D-coded, 4 -pin Shielded: Yes Cable length: 1,000 mm Sheathing material: PUR
	50135081	KSS ET-M12-4A-RJ45-A-P7-050	Interconnection cable	Suitable for interface: Ethernet Connection 1: Connector, M12, Axial, Male, D-coded, 4 -pin Connection 2: RJ45 Shielded: Yes Cable length: 5,000 mm Sheathing material: PUR

Connection technology - Connectors

	Part no.	Designation	Article	Description
	50020501	KD 095-5A	Connector	Connection: Connector, M12, Axial, Female, A-coded, 5 -pin
	50112155	S-M12A-ET	Connector	Suitable for interface: Ethernet Connection: Connector, M12, Axial, Male, D-coded, 4 -pin

Services

	Part no.	Designation	Article	Description
	S981001	CS10-S-110	Start-up support	<p>Details: Performed at location of customer's choosing, duration: max. 10 hours.</p> <p>Conditions: Devices and connection cables are already mounted, price not including travel costs and, if applicable, accommodation expenses.</p> <p>Restrictions: No mechanical (mounting) and electrical (wiring) work performed, no changes (attachments, wiring, programming) to third-party components in the nearby environment.</p>
	S981005	CS10-T-110	Product training	<p>Details: Location and content to be agreed upon, duration: max. 10 hours.</p> <p>Conditions: Price not including travel costs and, if applicable, accommodation expenses.</p> <p>Restrictions: Travel costs and accommodation expenses charged separately and according to expenditure.</p>