

ET 328

Energetic reflection light scanner

en 04-2015/09 50123665



1 ... 1000mm
5 ... 450mm
(with 90° angular optics)



- Energetic reflection light scanner
- Scanning range adjustment via teach-in
- Visible red light
- Axial and 90° light beam gate for flexible integration
- Sturdy plastic housing with stainless steel threaded sleeve with cylindrical M18x1 design
- Active suppression of extraneous light A²LS
- Fast alignment through *brightVision*®
- Simple fine adjustment via *omni-mount*
- Full control through green and yellow indicator LEDs

Dimensioned drawing

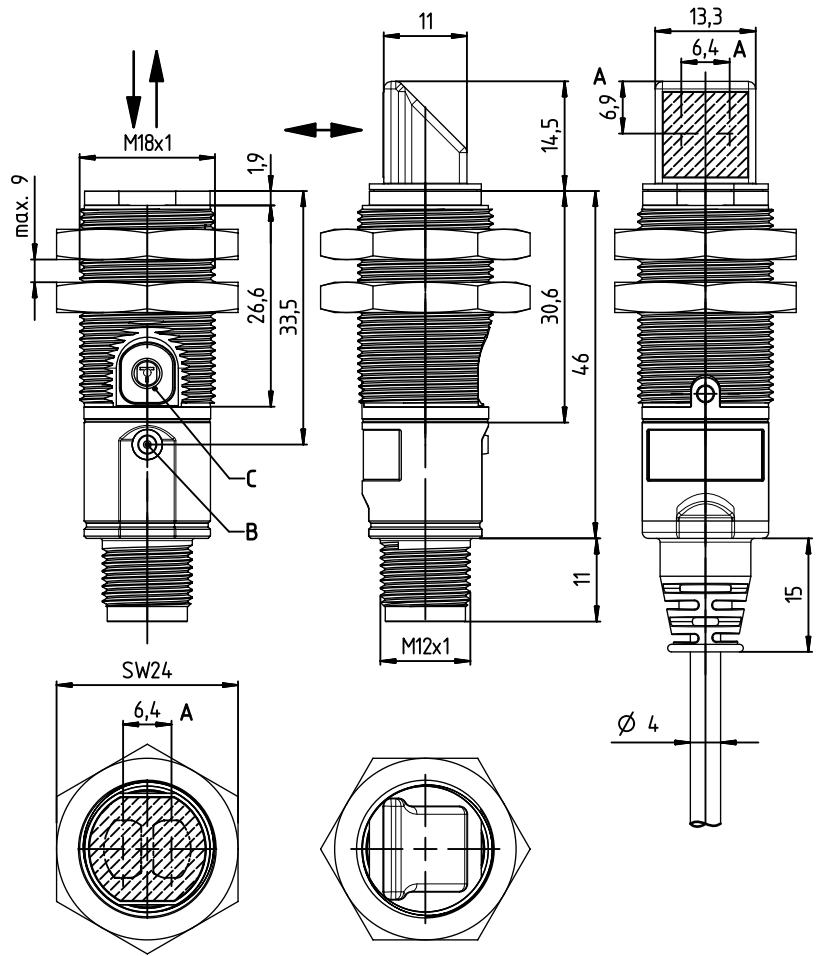

- A** Optical axes
- B** Indicator diode
- C** Teach button

Electrical connection



Accessories:

(available separately)

- Mounting systems (BT D18M.5, BT 318...)
- M12 connectors (KD ...)
- Ready-made cables (K-D ...)

We reserve the right to make changes • DS_ET328_en_50123665.fm



Specifications

Optical data

| | |
|------------------------------------|--|
| Scanning range limit ¹⁾ | axial optics: 1 ... 1000mm |
| Scanning range ²⁾ | 90° optics: 5 ... 450mm |
| Light source | see tables |
| Wavelength | LED (modulated light) 620nm (visible red light) |

Timing

| | |
|-----------------------|---------|
| Switching frequency | 500Hz |
| Response time | 1ms |
| Delay before start-up | ≤ 300ms |

Electrical data

| | |
|---------------------------------------|--|
| Operating voltage U_B ³⁾ | 10 ... 30VDC (incl. residual ripple) |
| Residual ripple | ≤ 15% of U_B |
| Open-circuit current | ≤ 20mA |
| Switching output | .../4P... 2 PNP transistor outputs pin 2: PNP dark switching, pin 4: PNP light switching .../2N... 2 NPN transistor outputs pin 2: NPN dark switching, pin 4: NPN light switching |
| Signal voltage high/low | ≥ ($U_B - 2.5V$) / ≤ 2.5V |
| Output current | max. 100mA ⁴⁾ |

Indicators

| | |
|------------|------------------------------|
| Green LED | ready |
| Yellow LED | reflection (object detected) |

Mechanical data

| | |
|-----------------|---|
| Housing | plastic with stainless steel threaded sleeve |
| Optics cover | plastic |
| Weight | 30g with M12 connector 80g with 2m cable |
| Connection type | M12 connector, 4-pin cable 2m, 4x0.20mm ² |

Environmental data

| | |
|-----------------------------------|--|
| Ambient temp. (operation/storage) | -40°C ... +60°C / -40°C ... +70°C |
| Protective circuit ⁵⁾ | 2, 3 |
| VDE safety class | III |
| Degree of protection | IP 67 |
| Light source | exempt group (in acc. with EN 62471) |
| Standards applied | IEC 60947-5-2 |
| Certifications | UL 508, C22.2 No.14-13 ³⁾ ⁶⁾ |

- 1) Scanning range limit: typical scanning range
- 2) Scanning range: ensured scanning range
- 3) For UL applications: for use in class 2 circuits according to NEC only
- 4) Sum of the output currents for both outputs, 50mA when ambient temperatures > 40°C
- 5) 2=polarity reversal protection, 3=short circuit protection for all outputs
- 6) These proximity switches shall be used with UL Listed Cable assemblies rated 30V, 0.5A min, in the field installation, or equivalent (categories: CYJV/CYJV7 or PVVA/PVVA7)

Tables

Axial optics:

| | | | |
|---|---|-----|------|
| 1 | 1 | 700 | 1000 |
| 2 | 1 | 590 | 850 |
| 3 | 3 | 390 | 550 |
| 4 | 5 | 280 | 400 |

90° optics:

| | | | |
|---|----|-----|-----|
| 1 | 5 | 350 | 450 |
| 2 | 10 | 290 | 380 |
| 3 | 12 | 190 | 250 |
| 4 | 15 | 140 | 200 |

| | |
|---|-----------|
| 1 | white 90% |
| 2 | gray 50% |
| 3 | gray 18% |
| 4 | black 6% |

- Scanning range [mm]
- Typ. scanning range limit [mm]

Diagrams

Axial optics:

Typ. black/white behavior

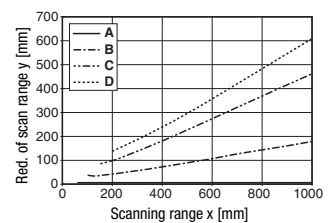

90° optics:

Typ. black/white behavior

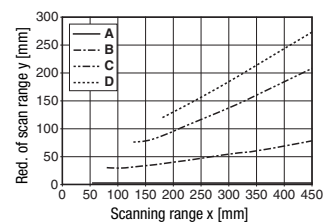

- A white 90%
- B gray 50%
- C gray 18%
- D black 6%

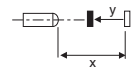

Remarks

Operate in accordance with intended use!

- ⚠ This product is not a safety sensor and is not intended as personnel protection.
- ⚠ The product may only be put into operation by competent persons.
- ⚠ Only use the product in accordance with the intended use.

- With the set scanning range, a tolerance of the scanning range limits is possible depending on the reflection properties of the material surface.

ET 328

Energetic reflection light scanner

Order guide

The sensors listed here are preferred types; current information at www.leuze.com.

| | | Designation | Part no. |
|--|---|------------------|----------|
| Sensors with axial optics | | | |
| With M12 connector | Pin 4: PNP light switching, pin 2: PNP dark switching | ET 328.3/4P-M12 | 50122726 |
| | Pin 4: NPN light switching, pin 2: NPN dark switching | ET 328.3/2N-M12 | 50122728 |
| With cable, 2m | Pin 4: PNP light switching, pin 2: PNP dark switching | ET 328.3/4P | 50122727 |
| | Pin 4: NPN light switching, pin 2: NPN dark switching | ET 328.3/2N | 50122729 |
| Sensors with 90° angular optics | | | |
| With M12 connector | Pin 4: PNP light switching, pin 2: PNP dark switching | ET 328.W3/4P-M12 | 50122721 |
| | Pin 4: NPN light switching, pin 2: NPN dark switching | ET 328.W3/2N-M12 | 50122724 |
| With cable, 2m | Pin 4: PNP light switching, pin 2: PNP dark switching | ET 328.W3/4P | 50122722 |
| | Pin 4: NPN light switching, pin 2: NPN dark switching | ET 328.W3/2N | 50122725 |
| Accessories for optimum fastening | | | |
| | Mounting system <i>omni-mount</i> | BT318B-0M | 50121904 |
| | Mounting bracket for standard mounting | BT D18M.5 | 50113548 |
| | Mounting bracket for <i>omni-mount</i> | BT D21M | 50117257 |

Part number code

| | | E | T | 3 | 2 | 8 | . | W | 3 | / | 4 | P | - | M | 1 | 2 |
|---|---|---|---|---|---|---|---|---|---|---|---|---|---|---|---|---|
| Operating principle | | | | | | | | | | | | | | | | |
| ET | Energetic reflection light scanner | | | | | | | | | | | | | | | |
| Series | | | | | | | | | | | | | | | | |
| 328 | 328 Series | | | | | | | | | | | | | | | |
| Equipment | | | | | | | | | | | | | | | | |
| .3 | Axial optics, teach-in via teach button | | | | | | | | | | | | | | | |
| .W3 | 90° angular optics, teach-in via teach button | | | | | | | | | | | | | | | |
| Switching output/function /OUT1OUT2 (OUT1 = Pin 4, OUT2 = Pin 2) | | | | | | | | | | | | | | | | |
| 4 | PNP, light switching | | | | | | | | | | | | | | | |
| P | PNP, dark switching | | | | | | | | | | | | | | | |
| 2 | NPN, light switching | | | | | | | | | | | | | | | |
| N | NPN, dark switching | | | | | | | | | | | | | | | |
| X | Pin not used | | | | | | | | | | | | | | | |
| Electrical connection | | | | | | | | | | | | | | | | |
| -M12 | M12 connector, 4-pin | | | | | | | | | | | | | | | |
| N/A | Cable, standard length 2m | | | | | | | | | | | | | | | |

Teach-in method

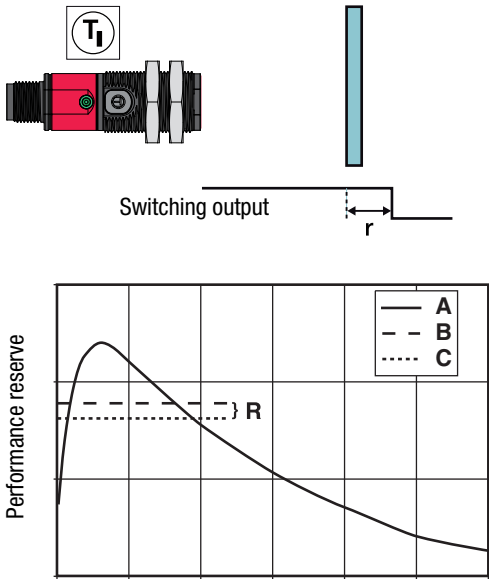
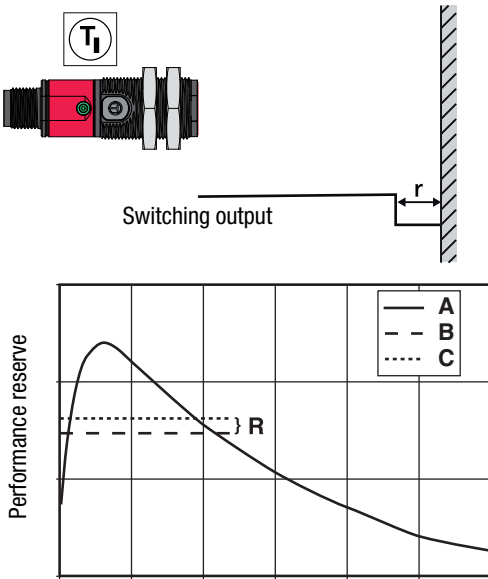
| Teach | Operating level 1 | Operating level 2 |
|----------------|---|---|
| Standard Teach | <p>Teach on object:</p> <p>With this teach event, the object is located in front of the sensor. The switching threshold is set by the teach so that the object is detected with tight signal reserve R. Thus, the object is detected even if the distance increases by the value r with respect to the distance during the teach.</p>  <p>A Signal - object B Teach on object C Switching threshold</p> | <p>Teach on background:</p> <p>This teach is only suitable for applications with a fixed background. The teach is performed directly on the background without an object. The switching threshold is set to a value that is just above the background signal (signal reserve R). Thus, objects can be detected up to a distance of r in front of the background.</p>  <p>A Signal - background B Teach on background C Switching threshold</p> |

Operation via teach button

Teach in operating level 1

- Press teach button until the **yellow** LED flashes.
- Release teach button.
- Ready.

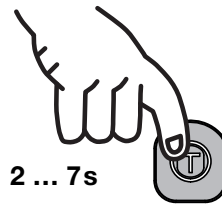

Teach in operating level 2

- Press teach button until **green** and **yellow** LEDs flash **alternately**.
- Release teach button.
- Ready.

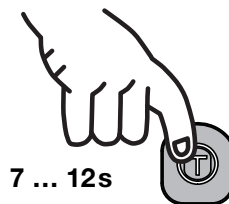

Adjusting the switching behavior of the switching output – light/dark switching

This function permits inversion of the sensors' switching logic.

- Press teach button until the **green** LED flashes.
- Release teach button.
- The LED then displays the changed switching logic for 2s:

- | | |
|-------------------------|--|
| YELLOW | = switching outputs light switching |
| Continuous light | (in the case of complementary sensors, Q1 (pin 4) light switching, Q2 (pin 2) dark switching), this means output active when object is detected. |
| GREEN | = switching outputs dark switching |
| Flashing light | (in the case of complementary sensors, Q1 (pin 4) dark switching, Q2 (pin 2) light switching), this means output inactive when object is detected. |

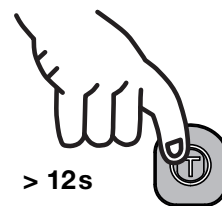

2s YELLOW = light switching

or

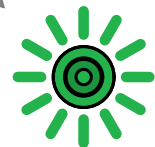

flashes GREEN for 2s = dark switching

- Ready.

