

GSU 06

Ultrasonic Label Fork

en 07-2011/01 50040961

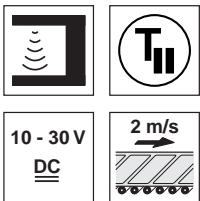

2.5mm

- Forked sensor for reliable detection of:
 - foil labels on foil carrier
 - foil labels on paper carrier
 - paper labels on paper carrier
 - metallic foil labels
 - thin metal foils
- Special variant for tape-tear monitoring
- Simple adjustment via teach-in by pressing a button or remote calibration ¹⁾
- Static PNP and NPN transistor outputs for optimum adaptation to the controller
- Robust metal housing with beveled inlet edges
- M8/M12 connector or cable version

Dimensioned drawing

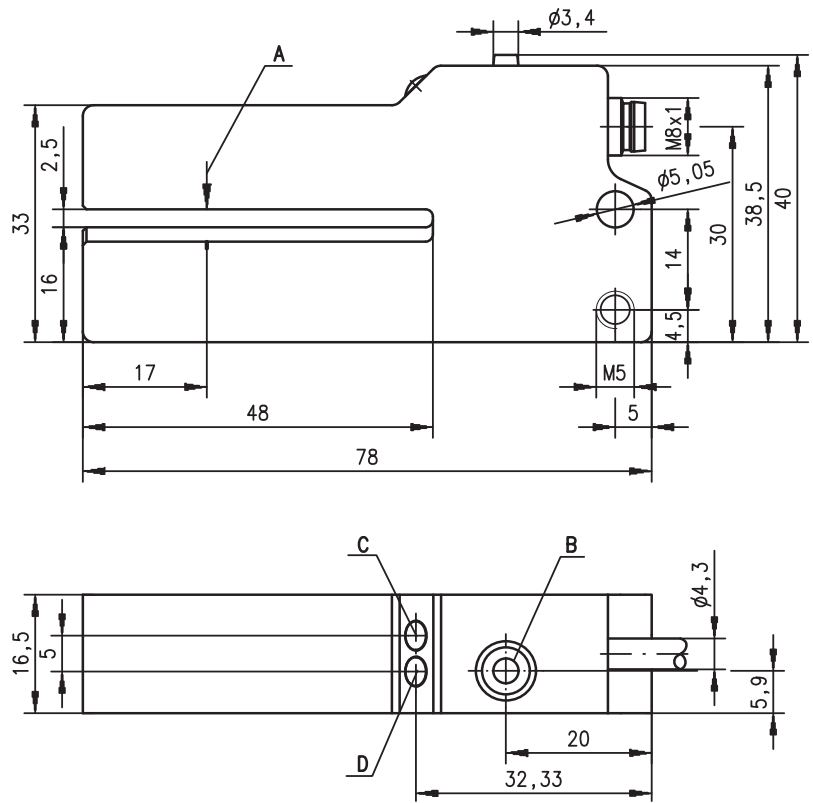

- A** Sensor marker
- B** Teach-in button ¹⁾
- C** Teach-in indicator diode ¹⁾
- D** Indicator diode switching output

Electrical connection

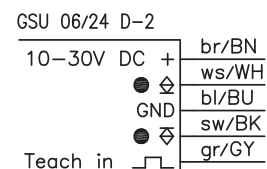
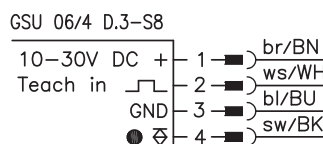
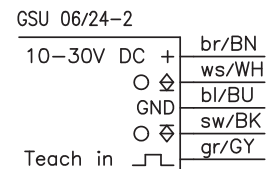
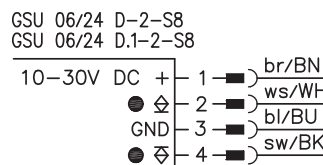
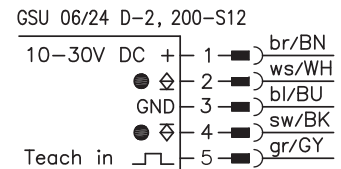
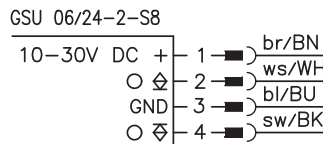

Accessories:

(available separately)

- M8/M12 connectors (KD ...)
- Ready-made cables M8/M12 (K-D ...)

We reserve the right to make changes • DS_GSU06_24_en.fm



Specifications

Physical data

Mouth width	2.5mm
Mouth depth	48mm
Label length ¹⁾	≥ 2mm
Label gap ¹⁾	≥ 2mm
Conveyor speed	≤ 2m/s (120m/min)
Repeatability ^{1) 2)}	± 0.3mm
Delay before start-up	≤ 100ms

Electrical data

Operating voltage U_B	10 ... 30VDC (incl. residual ripple)
Residual ripple	≤ 15% of U_B
Open-circuit current	≤ 40mA
Switching outputs	PNP and NPN transistor output
Function characteristics	light or dark switching
Signal voltage high/low	≥ ($U_B - 2V$) ≤ 2V
Output current	2x100mA

Indicators

Green LED	ready
Green LED, flashing	teach-in activated
Yellow LED	switching point in the label gap

Mechanical data

Housing	aluminum, anodized
Color	red/black
Weight	150g (connector/cable 60g)
Connection type	M8 connector, 4-pin, or 2000mm cable, 5-pin, or cable 200mm with M12 connector, 5-pin

Environmental data

Ambient temp. (operation/storage)	+5°C ... +50°C/-40°C ... +70°C
Protective circuit ³⁾	1, 2
VDE safety class	III
Protection class	IP 62
Standards applied	IEC 60947-5-2

Options (cable version)

Teach-in input	
Active/not active	≥ 8V/≤ 2V
Activation/disable delay	≤ 0.2ms
Input resistance	10kΩ

- 1) Not applicable for GSU 06/24D.1-2-S8
 2) Material dependent
 3) 1=polarity reversal protection, 2=short-circuit protection for all outputs

Order guide

	Designation	Part No.
Light switching (signal in the label gap)		
With M8 connector, teach-in by pressing a button	GSU 06/24-2-S8	50039638
With 2m cable, teach-in by pressing a button or via remote calibration	GSU 06/24-2	50040191
Dark switching (signal on the label)		
With M8 connector, teach-in by pressing a button	GSU 06/24D-2-S8	50040190
With M8 connector, teach-in by pressing a button or via remote calibration ¹⁾	GSU 06/4D.3-S8	50102921
With 2m cable, teach-in by pressing a button or via remote calibration	GSU 06/24D-2	50040192
With 0.2m cable with M12 connector, teach-in by pressing a button or remote calibration	GSU 06/24D-2, 200-S12	50108819
With M8 connector, specifically for tape-tear monitoring, without adjustment	GSU 06/24D.1-2-S8	50105735

1) When using right-angle plugs: cable outlet should point upward!

Calibration ¹⁾

Manual teach-in

- Insert label tape.
- The button on the device is pressed to teach - green LED flashes.
- Label tape advances so that 5 ... 10 label gaps pass through the measuring zone.
- The button is then pressed again. The green LED illuminates continuously. The teaching process is concluded.

Remote teach-in

- Insert label tape.
- Apply voltage at "Teach in" control input. Teach-in is activated.
- Advance 5 ... 10 label gaps through the sensor.
- Remove voltage. Teach-in is finished

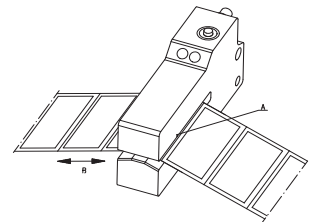

A Sensor center, marker
 B Label run

Remarks

- **Approved purpose:**
 This product may only be used by qualified personnel and must only be used for the approved purpose. This sensor is not a safety sensor and is not to be used for the protection of persons.
- The center of the label tape should be positioned above the sensor's marker (A).
- To achieve high repeatability, the label tape must be slightly under tension (B).
- The label material used determines the achievable precision and the reliability of gap detection!
- With special variant GSU 06/24D.1-2-S8 for tape-tear monitoring, no adjustment is necessary.