

HRTR 3B "XL"

Diffuse reflection light scanner with background suppression

en 09-2011/12 50107306-01



Dimensioned drawing

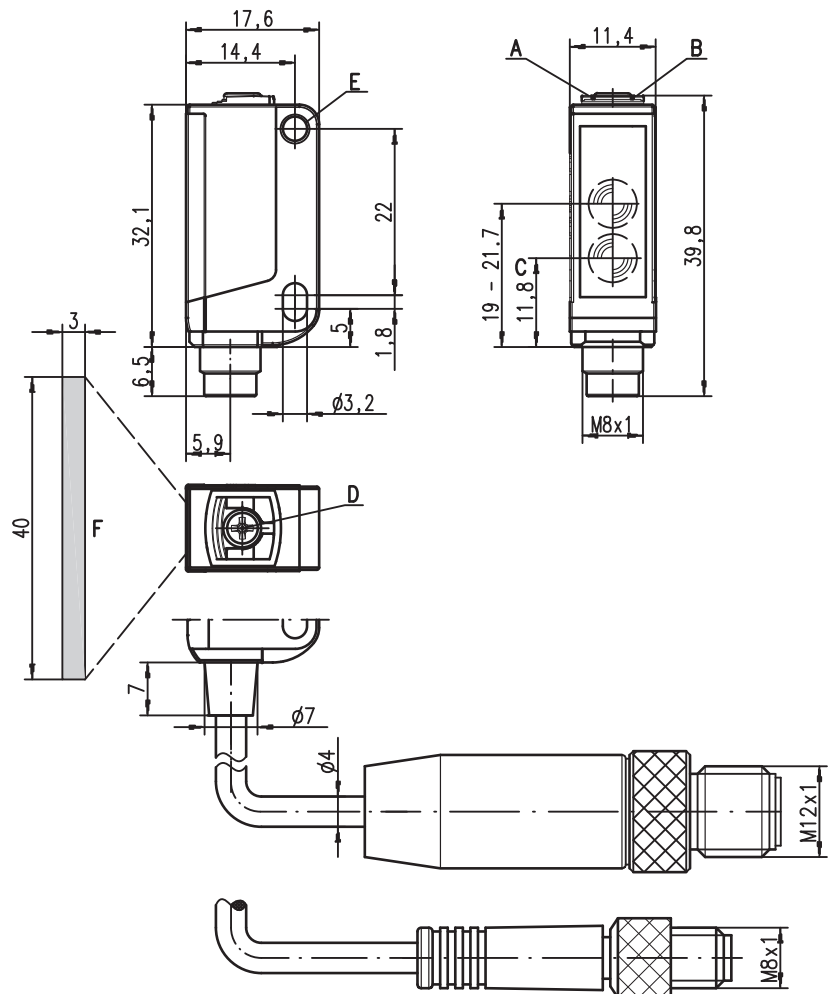

- A** Green indicator diode
- B** Yellow indicator diode
- C** Optical axis
- D** 8-turn potentiometer for scanning range adjustment
- E** Attachment sleeve
- F** Light spot 3x40mm at a scanning range of 50mm



5 ... 100mm
60mm with
black-white error < 10%



- Diffuse reflection light scanner with visible red light and adjustable background suppression
- Wide, rectangular light spot guarantees the reliable detection of:
 - objects with openings, holes and grooves
 - transparent foils and bottles
 - objects with grid structures (e.g. blister packs)
 - objects with variable position
- Small and compact construction with robust plastic housing, protection class IP 67 for industrial application
- A²LS- Active Ambient Light Suppression
- Push-pull switching outputs
- High switching frequency for detection of fast events

Electrical connection

Plug connection, 4-pin

10-30V DC +	1	br/BN
OUT 2	2	ws/WH
GND	3	bl/BU
OUT 1	4	sw/BK

Cable, 4-wire

10-30V DC +	br/BN
OUT 2	ws/WH
GND	bl/BU
OUT 1	sw/BK

Plug connection, 3-pin

10-30V DC +	1	br/BN
GND	3	bl/BU
OUT 1	4	sw/BK

Accessories:

(available separately)

- Mounting systems (BT 3...)
- Cable with M8 or M12 connector (K-D ...)

We reserve the right to make changes • DS_HRTR3B_XL_en.fm

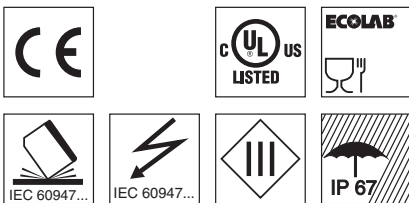

Specifications

Optical data

Typ. scanning range limit ¹⁾	5 ... 100mm
Scanning range ²⁾	see tables
Adjustment range	20 ... 100mm
Light spot	approx. 3 x 40mm ² at 50mm
Light source ³⁾	LED (modulated light)
Wavelength	620nm (visible red light)

Timing

Switching frequency	1,000Hz
Response time	0.5ms
Delay before start-up	≤ 300ms (acc. to. IEC 60947-5-2)

Electrical data

Operating voltage U _B ⁴⁾	10 ... 30VDC (incl. residual ripple)
Residual ripple	≤ 15% of U _B
Open-circuit current	≤ 15mA
Switching output	.../66 ⁵⁾ 2 push-pull switching outputs pin 2: PNP dark switching, NPN light switching pin 4: PNP light switching, NPN dark switching .../6 ⁵⁾ 1 push-pull switching output pin 4: PNP light switching, NPN dark switching .../6D ⁵⁾ 1 push-pull switching output pin 4: PNP dark switching, NPN light switching .../44 2 PNP switching outputs, complementary .../4 1 PNP switching output light switching, pin 2: not connected ⁶⁾
Function characteristics	light/dark switching
Signal voltage high/low	≥ (U _B -2V)/≤ 2V
Output current	max. 100mA
Scanning range	adjustable via 8-turn potentiometer

Indicators

Green LED	ready
Yellow LED	object detected - reflection

Mechanical data

Housing ⁷⁾	plastic (PC-ABS); 1 attachment sleeve, nickel-plated steel
Optics cover	plastic (PMMA)
Weight	with connector: 10g with 200mm cable and connector: 20g with 2m cable: 50g
Connection type	2m cable (cross section 4x0.20mm ²), connector M8 metal, 0.2m cable with connector M8 or M12

Environmental data

Ambient temp. (operation/storage)	-30°C ... +55°C/-30°C ... +70°C
Protective circuit ⁸⁾	2, 3
VDE safety class	III
Protection class	IP 67
Light source	free group (in accordance with EN 62471)
Standards applied	IEC 60947-5-2
Certifications	UL 508 ⁴⁾

- 1) Typ. scan. range limit: max. achievable scanning range for light objects (white 90%)
- 2) Scanning range: recommended scanning range for objects with different diffuse reflection
- 3) Average life expectancy 100,000h at an ambient temperature of 25°C
- 4) For UL applications: for use in class 2 circuits according to NEC only
- 5) The push-pull switching outputs must not be connected in parallel
- 6) Pin 2: unassigned, hence especially suitable for the connection to AS-interface I/O coupling modules
- 7) Patent Pending Publ. No. US 7,476,848 B2
- 8) 2=polarity reversal protection, 3=short-circuit protection for all transistor outputs

Remarks

Adapter plate:

BT 3.2 (part no. 50103844) for alternate mounting on 25.4 mm hole spacing (Omron E3Z, Sick W100...)

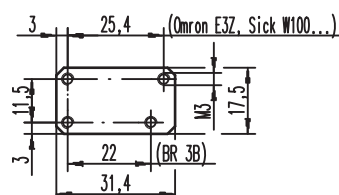

Tables

1	5	50	100
2	5	45	90
3	5	40	80

1	white 90%
2	grey 18%
3	black 6%

Scanning range [mm]
Typ. scanning range limit [mm]

Diagrams

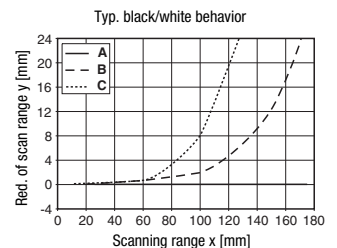
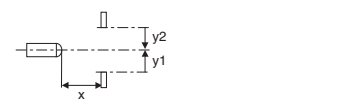
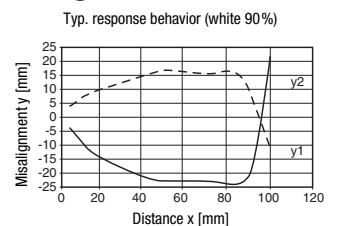

- A white 90%
- B grey 18%
- C black 6%

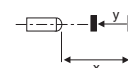

Remarks













Mounting system:



- ① = BT 3 (part no. 50060511)
- ②+③ = BT 3.1 ¹⁾ (part no. 50105585)
- ①+②+③ = BT 3B (part no. 50105546)

1) Packaging unit: PU = 10 pcs.

HRTR 3B "XL"
Diffuse reflection light scanner with background suppression
Order guide

Selection table			Order code →										
Equipment ↓			HRTR 3B/66-XL Part No. 50107246	HRTR 3B/66-XL-S8 Part No. 50107247	HRTR 3B/66-XL, 200-S8 Part No. 50107248	HRTR 3B/66-XL, 200-S12 Part No. 50107249	HRTR 3B/44-XL-S8 Part No. 50107250	HRTR 3B/4-XL-S8 Part No. 50107299	HRTR 3B/44-XL, 200-S12 Part No. 50107251	HRTR 3B/6-XL-S8.3 Part No. 50109485	HRTR 3B/44.03-XL, 200-S12 Part No. 50109487	HRTR 3B/6D-XL-S8.3 Part No. 50111444	
Output 1 (OUT 1)	push-pull switching output	 light switching	●	●	●	●					●		
		 dark switching											●
	PNP transistor output	 light switching					●	●	●				●
		 dark switching											
	NPN transistor output	 light switching											
		 dark switching											
Output 2 (OUT 2)	push-pull switching output	 light switching											
		 dark switching	●	●	●	●							
	PNP transistor output	 light switching							●	●		●	
		 dark switching											
	NPN transistor output	 light switching											
		 dark switching											
Connection	cable 2,000mm	4-wire	●										
	M8 connector, metal	3-pin								●		●	
	M8 connector, metal	4-pin		●			●	●					
	200mm cable with M8 connector	4-pin			●								
	200mm cable with M12 connector	4-pin				●			●		● ¹⁾		
	200mm cable with XHP connector	4-pin				●			●				
	pin 2: not assigned, suitable for connecting to AS-i coupling module								●				
Configuration	freely adjustable via 8-turn potentiometer		●	●	●	●	●	●	●	●	●	●	
	preset to scanning range [mm]:												

1) Connector without Ultra-Lock™ fast locking

Application notes



- **Approved purpose:**

This product may only be used by qualified personnel and must only be used for the approved purpose. This sensor is not a safety sensor and is not to be used for the protection of persons.

- When detecting glossy surfaces (e.g. metals), the light beam should not be incident on the object surface at a right angle. A slight inclination is sufficient for preventing undesired direct reflections. The following rule of thumb applies: the smaller the scanning range, the larger the angle of inclination (approx. $5^\circ \dots 7^\circ$).

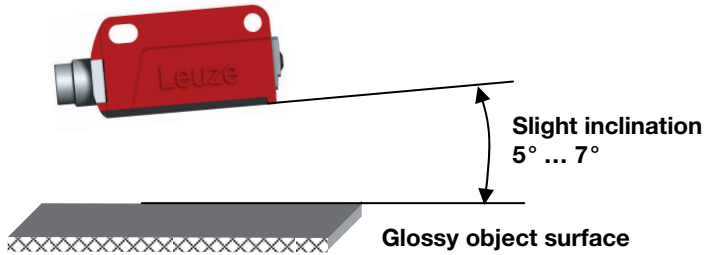

- Outside of the scanning range, the sensor operates as an energetic diffuse reflection light scanner. Light objects can still be reliably detected up to the scanning range limit.
- The sensors are equipped with effective measures for the maximum avoidance of mutual interference should they be mounted opposite one another. Opposite mounting of multiple sensors of the same type should, however, absolutely be avoided.