

ODSL 8

Optical laser distance sensors

en 03-2011/12 50109921-01



Dimensioned drawing

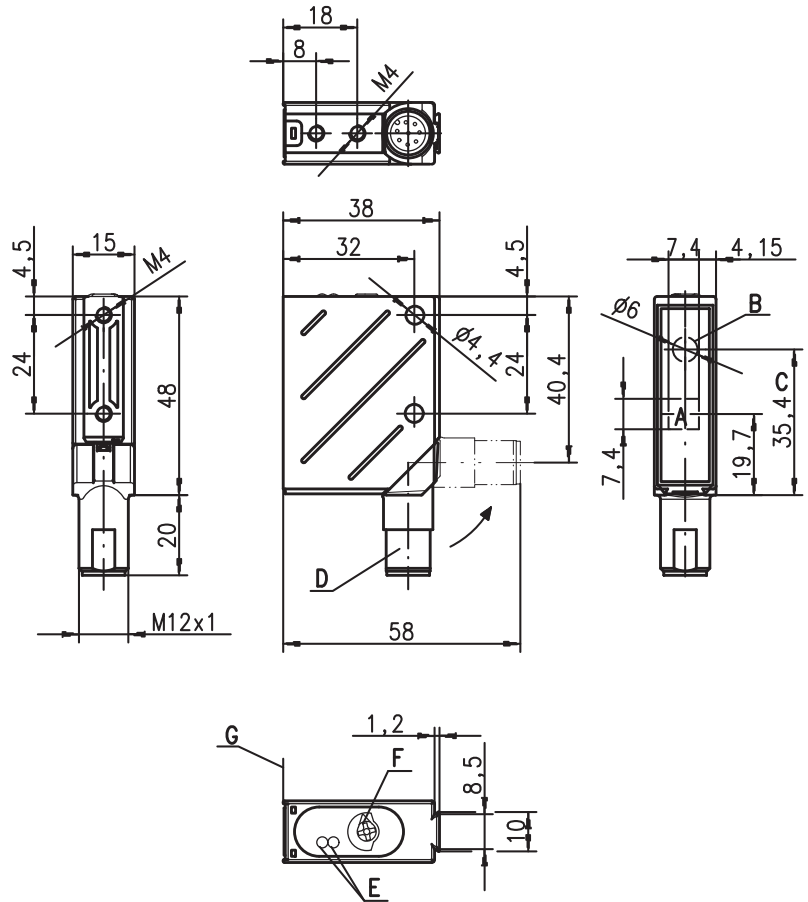

- A Receiver
- B Transmitter
- C Optical axis
- D 90° turning connector
- E LED yellow, green
- F Operational control (rotary switch)
- G Reference edge for the measurement (cover glass)

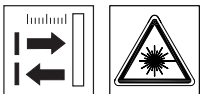

25 ... 45 mm

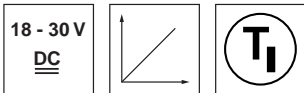

- Reflection-independent distance information
- Analog voltage output or current output (can be inverted, teachable)
- 2 teachable switching outputs (push-pull)
- M12 turning connector
- Easy alignment through visible red light

Electrical connection

ODSL 8/V66-45-S12

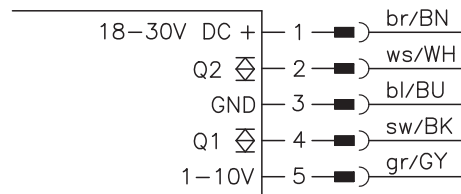

ODSL 8/C66-45-S12

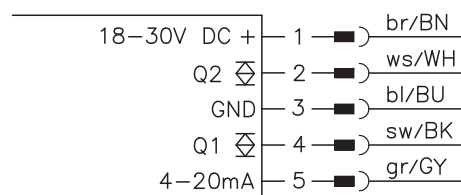

We reserve the right to make changes • DS_ODSL8_V66_C66_45_en.fm



Accessories:

(available separately)

- Mounting systems
- Cable with M12 connector (K-D ...)
- Control guard

Specifications

Optical data

Measurement range ¹⁾	25 ... 45mm
Resolution ²⁾	0.03mm
Light source	laser
Wavelength	650nm (visible red light)
Max. output power	<1.2 mW
Pulse duration	4ms
Light spot	Ø 1mm at 45mm
Laser warning notice	see remarks

Error limits (relative to measurement distance)

Absolute measurement accuracy ¹⁾	± 1.5%
Repeatability ³⁾	± 0.2%
B/W detection thresh. (6 ... 90% rem.)	≤ 1.5%
Temperature drift	≤ 0.2%/°C

Timing

Measurement time	2 ... 7ms
Response time	≤ 20ms
Delay before start-up	≤ 300ms

Electrical data

Operating voltage U_B	18 ... 30VDC (incl. residual ripple)
Residual ripple	≤ 15% of U_B
Open-circuit current	≤ 50mA
Switching output/function ⁴⁾	2 push-pull switching outputs pin 2: Q2, PNP light switching, NPN dark switching pin 4: Q1, PNP light switching, NPN dark switching
Signal voltage high/low	≥ ($U_B - 2V$) / ≤ 2V
Analog output	voltage 1 ... 10V, R_L ≥ 2kW / current 4 ... 20mA, R_L < 500Ω

Indicators

Green LED	continuous light	ready
	flashing (no teach)	fault, teach values were not applied
	off	no voltage
Yellow LED	continuous light	object within teach-in measurement distance (output Q1 ⁵⁾)
	flashing (no teach)	teach values were not applied
	off	object outside teach-in measurement distance (output Q1 ⁴⁾)

Mechanical data

Housing	metal
Optics cover	glass
Weight	70g
Connection type	M12 connector, 5-pin, turning

Environmental data

Ambient temp. (operation/storage)	-40°C ... +50°C / -40°C ... +70°C
Protective circuit ⁶⁾	2, 3
VDE safety class ⁷⁾	II, all-insulated
Protection class ⁸⁾	IP 67, IP 69K ⁹⁾
Laser class	2 (acc. to EN 60825-1)
Standards applied	IEC 60947-5-2

- 1) Luminosity coefficient 6% ... 90%, at 20°C, measurement object ≥ 20x20mm²
- 2) Minimum and maximum value depend on measurement distance and configuration of the analog output
- 3) Same object, identical environmental conditions, measurement object ≥ 20x20mm²
- 4) The push-pull switching outputs must not be connected in parallel
- 5) No display for output Q2
- 6) 2=polarity reversal protection, 3=short-circuit protection for all outputs
- 7) Rating voltage 250 VAC
- 8) In stop position of the turning connector (turning connector locked)
- 9) IP 69K test acc. to DIN 40050 part 9 simulated, high pressure cleaning conditions without the use of additives, acids and bases are not part of the test

Characteristic curve of analog output:

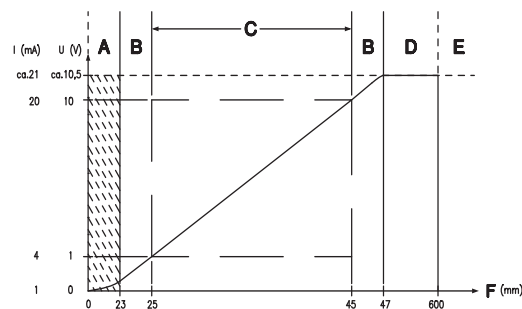

- A Area not defined
- B Linearity not defined
- C Measurement range
- D Object present
- E No object detected
- F Measurement distance

Order guide

With M12 connector
and voltage output
and current output

Designation	Part no.
ODSL 8/V66-45-S12	50108363
ODSL 8/C66-45-S12	50108364

ODSL 8/V66-45-S12 - 03
ODSL 8/C66-45-S12 - 03

Tables

Diagrams

Characteristic curve of switching outputs:

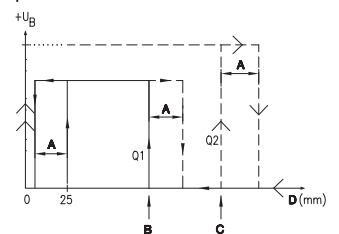

- A Hysteresis
- B Switching point Q1 (teach point)
- C Switching point Q2 (teach point)
- D Measurement distance

Remarks

- Measurement time depends on the reflectivity of the measurement object and on the measurement mode.
- **Approved purpose:** The ODSL 8 laser distance sensors are optical electronic sensors for the optical, contactless measurement of distance to objects.

ODSL 8

Optical laser distance sensors

T₁ teach-in with rotary switch

1. Position measurement object at the desired measurement distance (①).

2. Turn rotary switch into the desired position (Low, High, 1, 2) (②).
Wait for optical confirmation by flashing of the LEDs.

Teach function	Rotary switch position	Green LED	Yellow LED
Analog output 1 V/4mA	low	On	Flashes
Analog output 10V/20mA	high	Flashes	On
Switching output Q1	1	Flash synchronously	
Switching output Q2	2	Flash alternately	

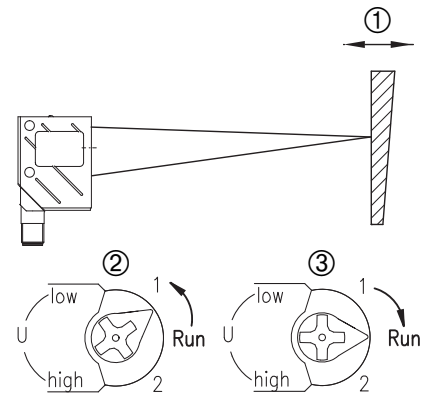

3. For teaching, position rotary switch onto "Run" (③).
Wait for optical confirmation by end of flashing signal (green LED on).

Reset of the analog output to factory settings

Reset 1 V/4mA analog output at 25mm:

1. Position measurement object just below start of measurement range (25mm).
2. Position rotary switch on "Low". Wait for optical confirmation by flashing of the LEDs.
3. For teaching, position rotary switch onto "Run".
Wait for optical confirmation by end of flashing signal (green LED on).

Reset 10V/20mA analog output at 45mm:

1. Position measurement object just beyond end of measurement range (45mm).
2. Position rotary switch on "High". Wait for optical confirmation by flashing of the LEDs.
3. For teaching, position rotary switch onto "Run".
Wait for optical confirmation by end of flashing signal (green LED on).

Error messages

Continuously flashing LEDs in switch position "Run" signal an unsuccessful teach event (sensor not ready):

Green LED	Yellow LED	Error
On	Flashes	Teach 1 V/4mA analog output unsuccessful
Flashes	On	Teach 10V/20mA analog output unsuccessful
Flash synchronously		Teach switching output Q1 unsuccessful
Flash alternately		Teach switching output Q1 unsuccessful

Remedy:

- Repeat teach event or
- Disconnect sensor from voltage to restore the old values.

Typical areas of application of optical distance sensors

Continuous distance measurement

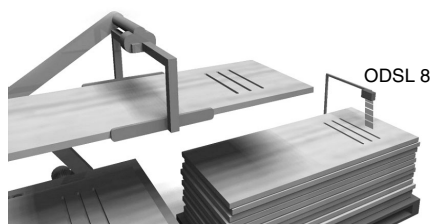

Positioning tasks



Filling level control

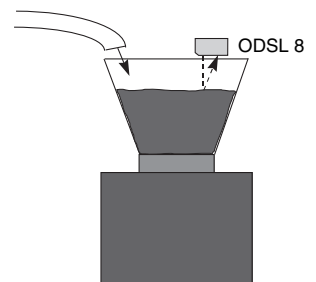

Installation instructions

Mounting systems are available which have to be ordered separately at Leuze electronic. Apart from this, the drilled-through holes and threaded holes are suitable for the individual mounting of the ODSL 8, depending on the area in which it is used. When mounting, avoid application of excessive force on the housing.

Preferred movement of the objects

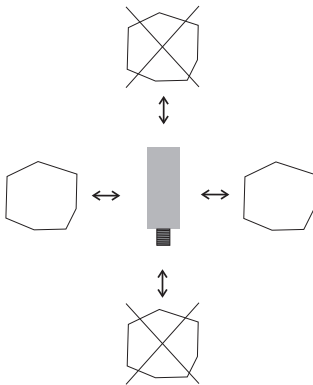

Preferred mounting in connection to objects with structured surface

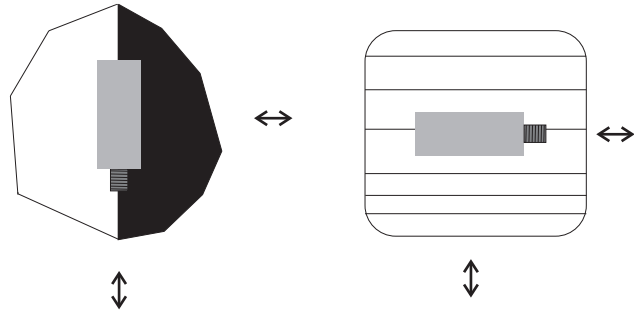

View through a chase

If the ODSL 8 has to be installed behind a cover, the chase has to have at least the size of the optical glass cover. Otherwise, a correct measurement is not possible or can not be guaranteed.

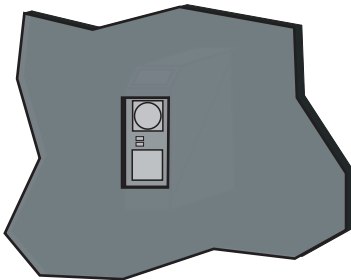

Alignment to measurement objects with reflecting surfaces

If the measurement object to be detected has a reflecting surface, a measurement may not be possible depending on the angle in which the light is reflected by the measurement object's surface. Adjust the angle between the sensor and the measurement object such that the sensor can reliably detect the measurement object.

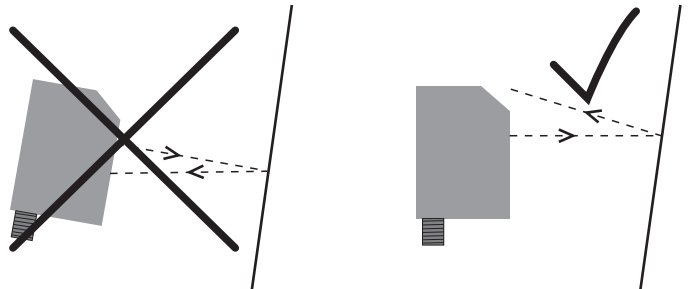

Working safely



Attention Laser Radiation!

The optical distance sensors ODSL 8 operate with a red light laser of class 2 acc. to EN 60825-1. If you look into the beam path over a longer time period, the retina of your eye may be damaged!

Never look directly into the beam path! Do not point the laser beam of the ODSL 8 at persons!

When mounting and aligning the ODSL 8 take care to avoid reflections of the laser beam off reflective surfaces!

The use of operating and adjusting devices other than those specified in the technical description, carrying out of differing procedures, or improper use of the optical laser distance sensor may lead to dangerous exposure to radiation!

The use of optical instruments or devices in combination with the device increases the danger of eye damage!

Adhere to the applicable legal and local regulations regarding protection from laser beams acc. to EN 60825-1 in its latest version.

The ODSL 8 uses a laser diode with low power in the visible red light range with an emitted wavelength of about 630nm.

The glass optics cover is the only opening through which the laser radiation can escape from the device. The housing of the ODSL 8 is sealed and has no parts that need to be adjusted or maintained by the user. The device must not be tampered with and must not be changed in any way! The destruction of the seal voids the warranty!



Notice!

It is important to attach the stick-on labels delivered with the device (notice signs)! If the signs could be covered due to the installation location of the ODSL 8, attach them close to the ODSL 8 so that it is not possible to look into the laser beam when reading the notices!