



Figure can vary

Part no.: 50136265
PRK3C.T3/PT-M8
Polarized retro-reflective photoelectric sensor



Contents

- Technical data
- Dimensioned drawings
- Electrical connection
- Diagrams
- Operation and display
- Reflectors & reflective tapes
- Part number code
- Notes
- Accessories

Technical data

| Basic data | |
|--------------------------|---|
| Series | 3C |
| Operating principle | Reflection principle |
| Application | Detection of highly transparent bottles Detection of transparent films |
| Special design | |
| Special design | Autocollimation Teach input |
| Optical data | |
| Operating range | Guaranteed operating range |
| Operating range | 0 ... 3 m , With reflector TK(S) 100x100 |
| Operating range limit | Typical operating range |
| Operating range limit | 0 ... 3.6 m , With reflector TK(S) 100x100 |
| Light source | LED , Red |
| LED light wavelength | 635 nm |
| Transmitted-signal shape | Pulsed |
| LED group | Exempt group (in acc. with EN 62471) |
| Electrical data | |
| Protective circuit | Polarity reversal protection Short circuit protected |
| Performance data | |
| Supply voltage U_B | 10 ... 30 V , DC , Incl. residual ripple |
| Residual ripple | 0 ... 15 % , From U_B |
| Open-circuit current | 0 ... 15 mA |
| Inputs | |
| Number of teach inputs | 1 Piece(s) |
| Teach inputs | |
| Voltage type | DC |
| Switching voltage | high: $\geq 0,65 \times U_B$ low: $\leq 0,35 \times U_B$ |
| Delay | 1 ms |
| Input resistance | 20,000 Ω |
| Teach input 1 | |
| Assignment | Connection 1, pin 2 |
| Function | Keyboard lockout Light/dark switching Sensitivity adjustment |
| Active switching state | High |

Outputs

Number of digital switching outputs 1 Piece(s)

Switching outputs

Voltage type DC
 Switching current, max. 100 mA
 Switching voltage High: $\geq(U_B-2V)$
 Low: $\leq 2V$

Switching output 1

Assignment Connection 1, pin 4
 Switching element Transistor , PNP
 Switching principle Dark switching

Timing

Switching frequency 1,500 Hz
 Response time 0.33 ms
 Readiness delay 300 ms
 Response jitter 110 μ s

Connection

Connection 1

Type of connection Connector
 Function Signal IN
 Signal OUT
 Voltage supply
 Thread size M8
 Type Male
 Material Metal
 No. of pins 4 -pin

Mechanical data

Dimension (W x H x L) 11.4 mm x 34.2 mm x 18.3 mm
 Housing material Plastic , PC-ABS
 Lens cover material Plastic / PMMA
 Net weight 10 g
 Housing color Red
 Type of fastening Through-hole mounting
 Via optional mounting device
 Compatibility of materials ECOLAB

Operation and display

Type of display LED
 Number of LEDs 2 Piece(s)
 Operational controls Teach button
 Function of the operational control Sensitivity adjustment

Environmental data

Ambient temperature, operation -40 ... 60 °C
 Ambient temperature, storage -40 ... 70 °C

Certifications

| | |
|----------------------|-----------------|
| Degree of protection | IP 67 IP 69K |
| Protection class | III |
| Certifications | c UL US |
| Standards applied | IEC 60947-5-2 |

Classification

| | |
|-----------------------|----------|
| Customs tariff number | 85365019 |
| eCl@ss 8.0 | 27270902 |
| eCl@ss 9.0 | 27270902 |
| ETIM 5.0 | EC002717 |
| ETIM 6.0 | EC002717 |

Dimensioned drawings

All dimensions in millimeters

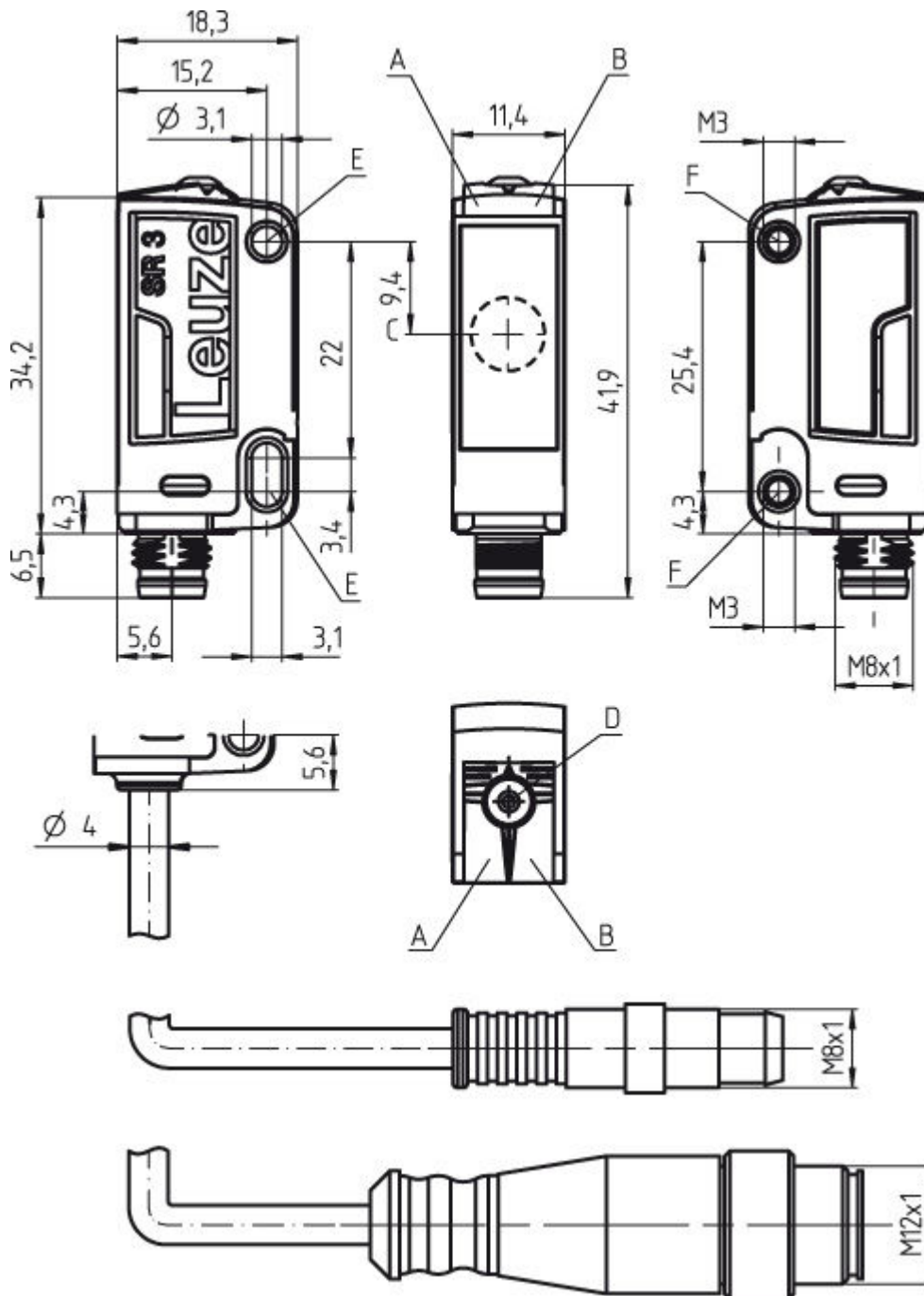

- A Green LED
- B Yellow LED
- C Optical axis
- D Teach button
- E Mounting sleeve (standard)
- F Threaded sleeve (3C.B series)

Electrical connection

| | |
|--------------------|-----------|
| Connection 1 | |
| Type of connection | Connector |

Part no.: 50136265 – PRK3C.T3/PT-M8 – Polarized retro-reflective photoelectric

| Connection 1 | |
|--------------|---|
| Function | Signal IN Signal OUT Voltage supply |
| Thread size | M8 |
| Type | Male |
| Material | Metal |
| No. of pins | 4 -pin |
| Encoding | |

| Pin | Pin assignment |
|-----|----------------|
| 1 | V+ |
| 2 | Teach-in |
| 3 | GND |
| 4 | OUT 1 |

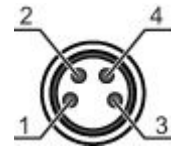

Diagrams

Typ. response behavior

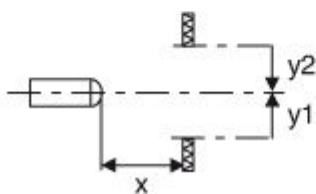
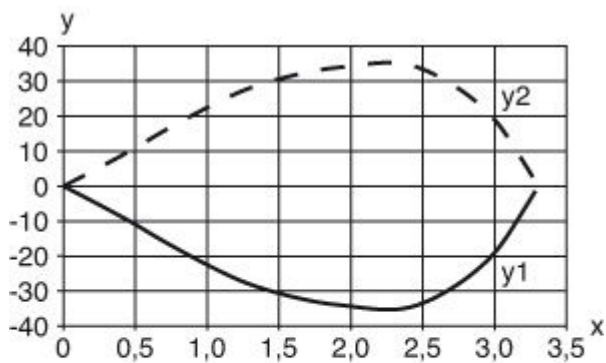

x Distance [m]
y Misalignment [mm]

Typ. function reserve

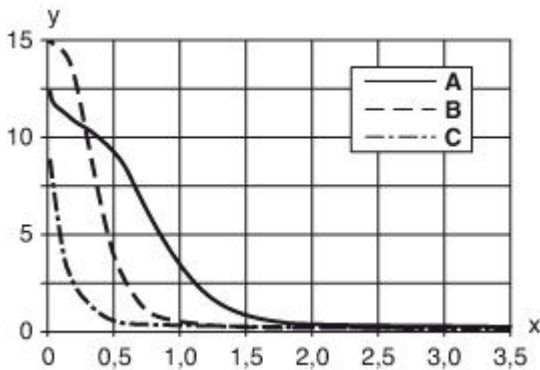



x Distance [m]
y Function reserve
A TKS 40x60
B TKS 20x40
C Film REF 4-A-50x50

Operation and display





LEDs

| LED | Display | Meaning |
|-----|--------------------------|--------------------------------------|
| 1 | Green, continuous light | Operational readiness |
| 2 | Yellow, continuous light | Light path free |
| | Yellow, flashing | Light path free, no function reserve |

Reflectors & reflective tapes

| | Part no. | Designation | Operating range/ Operating range limit | Description |
|---|----------|---------------|---|--|
|  | 50117583 | MTKS 50x50.1 | 0 ... 1.3 m 0 ... 1.6 m | Design: Rectangular Reflective surface: 50 mm x 50 mm Triple reflector size: 1.2 mm Material: Plastic Base material: Plastic Chemical designation of the material: PMMA8N Fastening: Through-hole mounting, Adhesive |
|  | 50110192 | REF 6-A-50x50 | 0 ... 1.2 m 0 ... 1.4 m | Design: Rectangular Reflective surface: 50 mm x 50 mm Triple reflector size: 0.3 mm Material: Plastic Chemical designation of the material: PMMA Fastening: Self-adhesive |

Part no.: 50136265 – PRK3C.T3/PT-M8 – Polarized retro-reflective photoelectric

| | Part no. | Designation | Operating range/ Operating range limit | Description |
|--|----------|-------------|---|--|
|  | 50003192 | TK 100x100 | 0 ... 3 m 0 ... 3.6 m | Design: Rectangular Reflective surface: 96 mm x 96 mm Triple reflector size: 4 mm Material: Plastic Base material: Plastic Chemical designation of the material: PMMA8N Fastening: Adhesive |
|  | 50022816 | TKS 100X100 | 0 ... 3 m 0 ... 3.6 m | Design: Rectangular Reflective surface: 96 mm x 96 mm Triple reflector size: 4 mm Material: Plastic Base material: Plastic Chemical designation of the material: PMMA8N Fastening: Through-hole mounting, Adhesive |
|  | 50081283 | TKS 20X40 | 0 ... 1 m 0 ... 1.2 m | Design: Rectangular Reflective surface: 16 mm x 38 mm Triple reflector size: 2.3 mm Material: Plastic Base material: Plastic Chemical designation of the material: PMMA8N Fastening: Through-hole mounting, Adhesive |
|  | 50040820 | TKS 40X60 | 0 ... 2 m 0 ... 2.4 m | Design: Rectangular Reflective surface: 37 mm x 56 mm Triple reflector size: 4 mm Material: Plastic Base material: Plastic Chemical designation of the material: PMMA8N Fastening: Through-hole mounting, Adhesive |

Part number code

Part designation: **AAA 3C d EE-f.GG H/i J-K**

| | |
|-------|---|
| AAA3C | Operating principle / construction: HT3C: diffuse reflection sensor with background suppression LS3C: throughbeam photoelectric sensor transmitter LE3C: throughbeam photoelectric sensor receiver PRK3C: retro-reflective photoelectric sensor with polarization filter |
| d | Light type: n/a: red light l: infrared light |
| EE | Light source: n/a: LED L1: laser class 1 L2: laser class 2 |
| f | Pre-set range (optional): n/a: operating range acc. to data sheet XXXX: pre-set range [mm] |
| GG | Equipment: n/a: standard A: autocollimation principle (single lens) for positioning tasks B: housing model with two M3 threaded sleeves, brass F: permanently set range L: long light spot S: small light spot T: autocollimation principle (single lens) for highly transparent bottles without tracking TT: autocollimation principle (single lens) for highly transparent bottles with tracking V: V-optics XL: extra long light spot |
| H | Operating range adjustment: n/a with HT: range adjustable via 8-turn potentiometer n/a with retro-reflective photoelectric sensors (PRK): operating range not adjustable 1: 270° potentiometer 3: teach-in via button 6: auto-teach |

| | |
|---|---|
| i | Switching output/function OUT 1/IN: Pin 4 or black conductor: 2: NPN transistor output, light switching N: NPN transistor output, dark switching 4: PNP transistor output, light switching P: PNP transistor output, dark switching 6: push-pull switching output, PNP light switching, NPN dark switching G: push-pull switching output, PNP dark switching, NPN light switching /L: IO-Link 8: activation input (activation with high signal) X: pin not used |
| J | Switching output / function OUT 2/IN: pin 2 or white conductor: 2: NPN transistor output, light switching N: NPN transistor output, dark switching 4: PNP transistor output, light switching P: PNP transistor output, dark switching 6: push-pull switching output, PNP light switching, NPN dark switching G: push-pull switching output, PNP dark switching, NPN light switching W: warning output X: pin not used 8: activation input (activation with high signal) 9: deactivation input (deactivation with high signal) T: teach-in via cable |
| K | Electrical connection: n/a: cable, standard length 2000 mm, 4-wire 5000: cable, standard length 5000 mm, 4-wire M8: M8 connector, 4-pin (plug) M8.3: M8 connector, 3-pin (plug) 200-M8: cable, length 200 mm with M8 connector, 4-pin, axial (plug) 200-M8.3: cable, length 200 mm with M8 connector, 3-pin, axial (plug) 200-M12: cable, length 200 mm with M12 connector, 4-pin, axial (plug) |

Note

A list with all available device types can be found on the Leuze electronic website at www.leuze.com.

Notes

Observe intended use!

- This product is not a safety sensor and is not intended as personnel protection.
- The product may only be put into operation by competent persons.
- Only use the product in accordance with its intended use.

For UL applications:





- For UL applications, use is only permitted in Class 2 circuits in accordance with the NEC (National Electric Code).
- These proximity switches shall be used with UL Listed Cable assemblies rated 30V, 0.5A min, in the field installation, or equivalent (categories: CYJV/CYJV7 or PVVA/PVVA7)

- Light source: Average life expectancy 100,000 h at an ambient temperature of 25 °C
- Response time: For short decay times, an ohmic load of approx. 5 kOhm is recommended
- Sum of the output currents for both outputs, 50 mA for ambient temperatures > 40 °C
- The light spot may not exceed the reflector.
- Use of MTK(S) or REF 6-A- reflective tape is preferred.
- For REF 6-A reflective tape, the sensor's side edge must be aligned parallel to the side edge of the reflective tape.

Part no.: 50136265 – PRK3C.T3/PT-M8 – Polarized retro-reflective photoelectric

Accessories

Connection technology - Connection cables

| | Part no. | Designation | Article | Description |
|--|----------|-------------------|------------------|--|
|   | 50130850 | KD U-M8-4A-V1-050 | Connection cable | Connection 1: Connector, M8, Axial, Female, 4 -pin Connection 2: Open end Shielded: No Cable length: 5,000 mm Sheathing material: PVC |
|   | 50130871 | KD U-M8-4W-V1-050 | Connection cable | Connection 1: Connector, M8, Angled, Female, 4 -pin Connection 2: Open end Shielded: No Cable length: 5,000 mm Sheathing material: PVC |

Mounting technology - Mounting brackets

| | Part no. | Designation | Article | Description |
|--|----------|-------------|-----------------|--|
|  | 50060511 | BT 3 | Mounting device | Design of mounting device: Angle, L-shape Fastening, at system: Through-hole mounting Mounting bracket, at device: Screw type Type of mounting device: Rigid Material: Metal |

Mounting technology - Rod mounts

| | Part no. | Designation | Article | Description |
|---|----------|--------------|-----------------|---|
|  | 50117255 | BTU 200M-D12 | Mounting system | Contains: 2x M3 x 16 screw, 2x M3 x 20 screw, 2x position washers Design of mounting device: Mounting system Fastening, at system: For 12 mm rod, Sheet-metal mounting Mounting bracket, at device: Screw type Type of mounting device: Clampable, Adjustable, Turning, 360° Material: Metal |

Micro-triad-type reflectors

| | Part no. | Designation | Article | Description |
|---|----------|--------------|-----------|--|
|  | 50117583 | MTKS 50x50.1 | Reflector | Design: Rectangular Reflective surface: 50 mm x 50 mm Triple reflector size: 1.2 mm Material: Plastic Base material: Plastic Chemical designation of the material: PMMA8N Fastening: Through-hole mounting, Adhesive |

Part no.: 50136265 – PRK3C.T3/PT-M8 – Polarized retro-reflective photoelectric
Reflective tapes for laser and clear-glass applications

| | Part no. | Designation | Article | Description |
|---|----------|-------------|-----------|--|
|  | 50109257 | TKS 40x60.1 | Reflector | Design: Rectangular Reflective surface: 37 mm x 56 mm Triple reflector size: 2.3 mm Material: Plastic Base material: Plastic Chemical designation of the material: PMMA8N Fastening: Through-hole mounting, Adhesive |