

RTFR 3B

Diffuse reflection light scanner with fading

en 04-2014/05 50108963-01



Dimensioned drawing

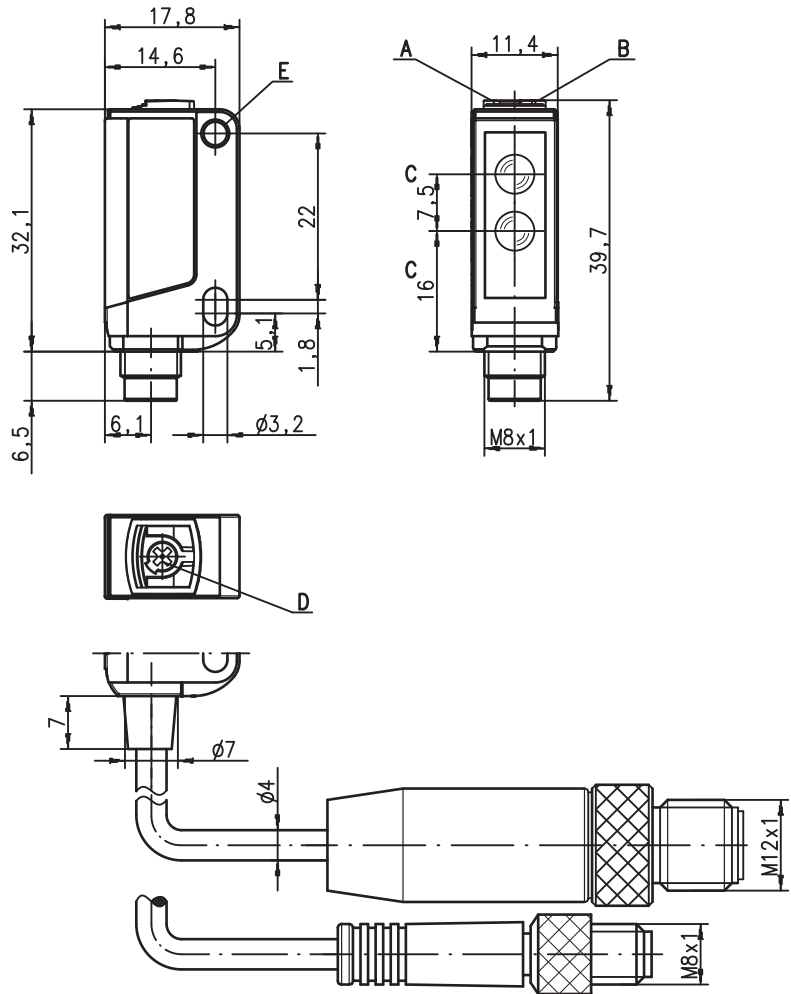

- A** Green indicator diode
- B** Yellow indicator diode
- C** Optical axis
- D** Potentiometer for scanning range adjustment
- E** Attachment sleeve

0 ... 450mm



- Diffuse reflection light scanner with visible red light
- Potentiometer for scanning range adjustment
- Small and compact construction with robust plastic housing, protection class IP 67 for industrial application
- Fast alignment through *brightVision*[®]
- A²LS- Active Ambient Light Suppression
- push-pull switching output
- High switching frequency for detection of fast events
- Low current consumption
- Fading: No object detection in the background

Electrical connection

Plug connection, 4-pin		
10-30V DC +	1	br/BN
OUT 2	2	ws/WH
GND	3	bl/BU
OUT 1	4	sw/BK

Cable, 4-wire		
10-30V DC +		br/BN
OUT 2		ws/WH
GND		bl/BU
OUT 1		sw/BK

Plug connection, 3-pin		
10-30V DC +	1	br/BN
GND	3	bl/BU
OUT 1	4	sw/BK

Accessories:

(available separately)

- Mounting systems (BT 3...)
- Cable with M8 or M12 connector (K-D ...)

We reserve the right to make changes • DS_RTFR3B_en_50108963_01.fm

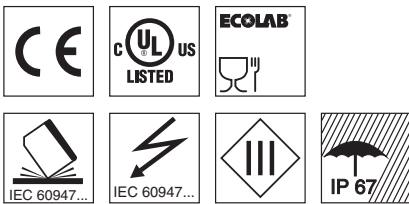

Specifications

Optical data

Typ. scanning range limit ¹⁾	0 ... 450mm
Scanning range ²⁾	0 ... 420mm ³⁾ , see table
Background behavior	from approx. 520mm no object detection ³⁾
Light source ⁴⁾	LED (modulated light)
Wavelength	620nm (visible red light)

Timing

Switching frequency	1,000Hz
Response time	0.5ms
Delay before start-up	≤ 300ms

Electrical data

Operating voltage U_B ⁵⁾	10 ... 30VDC (incl. residual ripple)
Residual ripple	≤ 15% of U_B
Open-circuit current	≤ 10mA
Switching output	.../66 ⁶⁾
	2 push-pull switching outputs
	pin 2: PNP dark switching, NPN light switching
	pin 4: PNP light switching, NPN dark switching
	.../6 ⁵⁾
	1 push-pull switching output
	pin 4: PNP light switching, NPN dark switching
	.../6D ⁵⁾
	1 push-pull switching output
	pin 4: PNP dark switching, NPN light switching
	light/dark switching
Function characteristics	
Signal voltage high/low	$\geq (U_B - 2V) / \leq 2V$
Output current	max. 100mA
Scanning range	adjustable with potentiometer, rotational angle approx. 250°

Indicators

Green LED	ready
Yellow LED	light path free

Mechanical data

Housing	plastic (PC-ABS); 1 attachment sleeve, nickel-plated steel
Optics cover	plastic (PMMA)
Weight	with connector: 10g
	with 200mm cable and connector: 20g
	with 2m cable: 50g
Connection type	2m cable (cross section 4x0.20mm ²), connector M8 metal, 0.2m cable with connector M8 or M12

Environmental data

Ambient temp. (operation/storage)	-30°C ... +55°C / -30°C ... +70°C
Protective circuit ⁷⁾	2, 3
VDE safety class	III
Protection class	IP 67
Light source	free group (in accordance with EN 62471)
Standards applied	IEC 60947-5-2
Certifications	UL 508, C22.2 No.14-13 ^{5) 8)}

Options

Warning output autoControl warn	PNP transistor, counting principle
Signal voltage high/low	$\geq (U_B - 2V) / \leq 2V$
Output current	max. 100mA

- 1) Typ. scan. range limit/adjustment range: max. achievable scanning range/adjustment range for light objects (white 90%)
- 2) Scanning range: recommended scanning range for objects with different diffuse reflection
- 3) Object white with 90% diffuse reflection
- 4) Average life expectancy 100,000h at an ambient temperature of 25°C
- 5) For UL applications: for use in class 2 circuits according to NEC only
- 6) The push-pull switching outputs must not be connected in parallel
- 7) 2=polarity reversal protection, 3=short-circuit protection for all transistor outputs
- 8) These proximity switches shall be used with UL Listed Cable assemblies rated 30V, 0.5A min, in the field installation, or equivalent (categories: CYJV/CYJV7 or PVVA/PVVA7)

Remarks

Adapter plate:

BT 3.2 (part no. 50103844) for alternate mounting on 25.4mm hole spacing (Omron E3Z, Sick W100...)

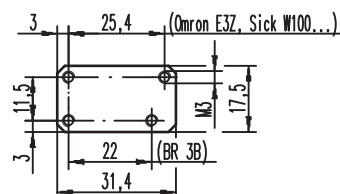

Tables

1	0	420	450
2	3	235	255
3	5	210	220

1	white 90%
2	gray 18%
3	black 6%

□	Scanning range [mm]
□	Typ. scanning range limit [mm]

Diagrams

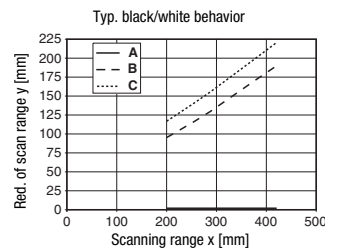

- A white 90%
- B gray 18%
- C black 6%

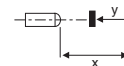

Remarks

Operate in accordance with intended use!

- ⚠ This product is not a safety sensor and is not intended as personnel protection.
- ⚠ The product may only be put into operation by competent persons.
- ⚠ Only use the product in accordance with the intended use.



- With the set scanning range, a tolerance of the scanning range limits is possible depending on the reflection properties of the material surface.
- Mounting system:



- ① = BT 3 (Part no. 50060511)
- ②+③ = BT 3.1 ¹⁾ (Part no. 50105585)
- ①+②+③ = BT 3B (Part no. 50105546)

1) Packaging unit: PU = 10 pcs.

RTFR 3B
Diffuse reflection light scanner with fading
Order guide

Selection table			Order code →					
Equipment ↓			RTFR 3B/66 Part no. 50108496	RTFR 3B/66-S8 Part no. 50108495	RTFR 3B/66,200-S8 Part no. 50108504	RTFR 3B/6-S8.3 Part no. 50108498	RTFR 3B/6D-S8.3 Part no. 50108499	
Output 1 (OUT 1)	push-pull switching output		light switching ○	●	●	●	●	
			dark switching ●					●
Output 2 (OUT 2)	push-pull switching output		light switching ○					
			dark switching ●	●	●	●		
Connection	cable 2,000 mm		4-wire	●				
	M8 connector, metal		3-pin				●	●
	M8 connector, metal		4-pin		●			
	200 mm cable with M8 connector		4-pin			●		

