

LOC	DIST	REVISIONS ÄNDERUNGEN			DATE	DWN	APVD
AI	-	P	LTR	DESCRIPTION BESCHREIBUNG			
PROJEKT NR. EGGMN04410		B3		ECR-21-123577	12JUL2022	RK	JB

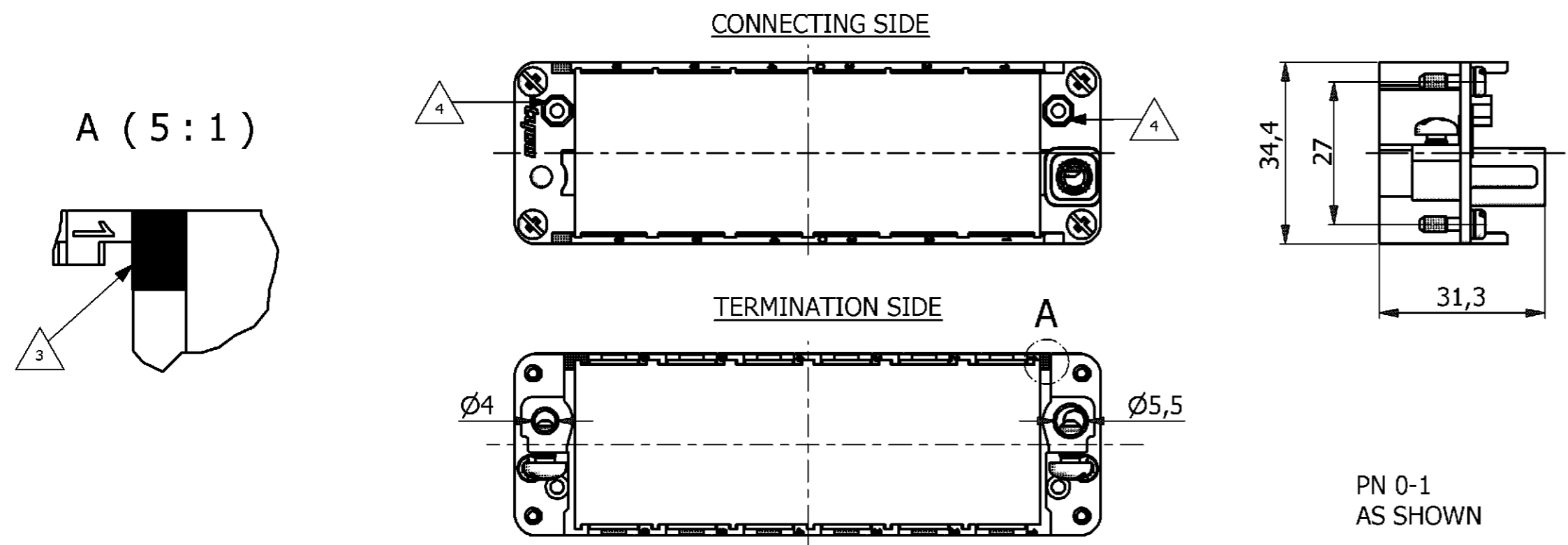

NOTES

- MODUL INSERTS: SERIES HVS SEE CATALOG PN: 889745
- SUITABLE HOOD SIZE 3 TO 8: SERIES HB; HD; EMV; HF AND HIP CATALOG PN: 889745
- MARKING OF POLARIZATION ACCORDING TO MARKINGS OF MODULE INSERTS
- POSITION FOR CODING SET PN: 530341-1
- PACKAGING: 10 SETS IN A CARTON, PRE MOUNTED

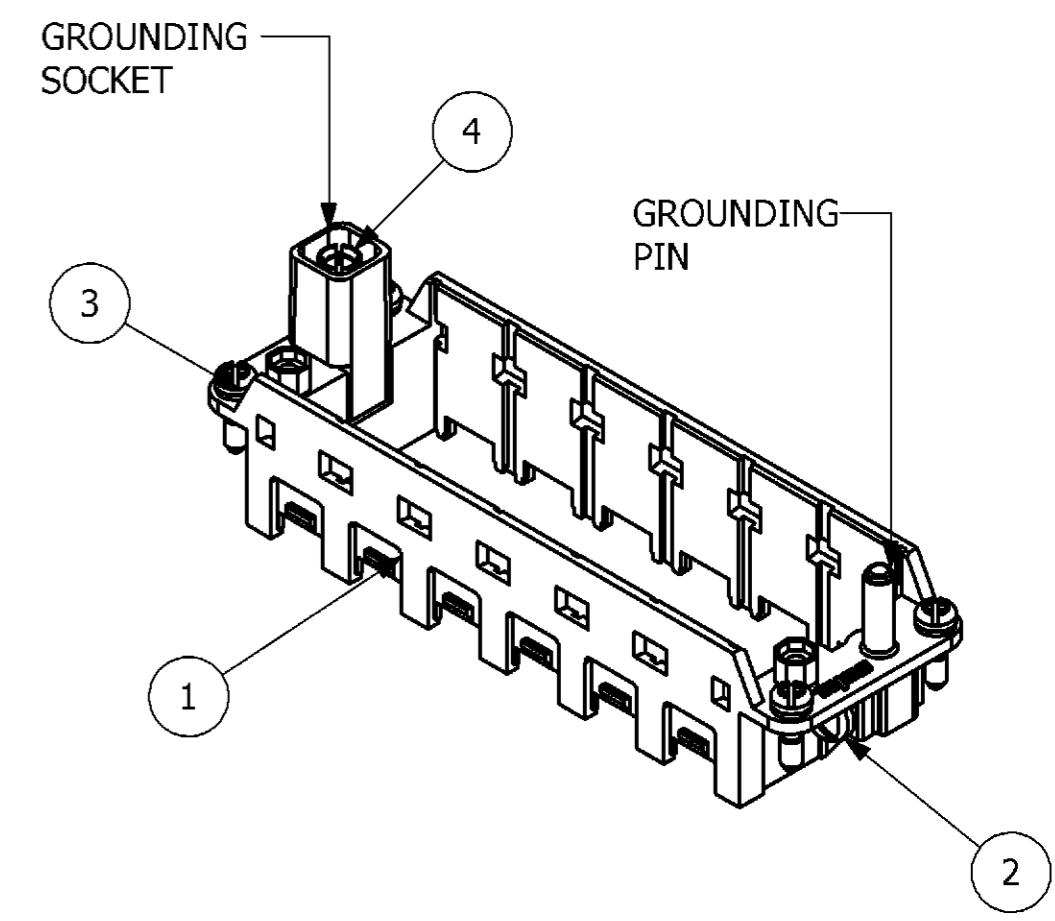
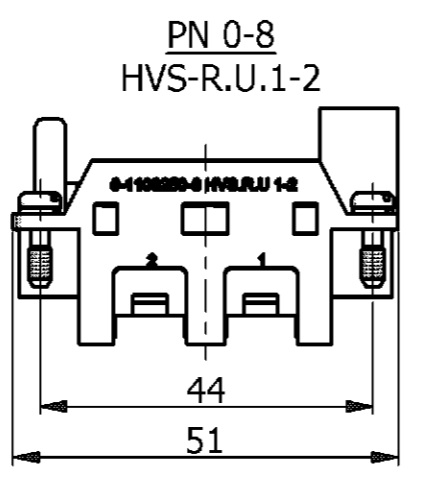
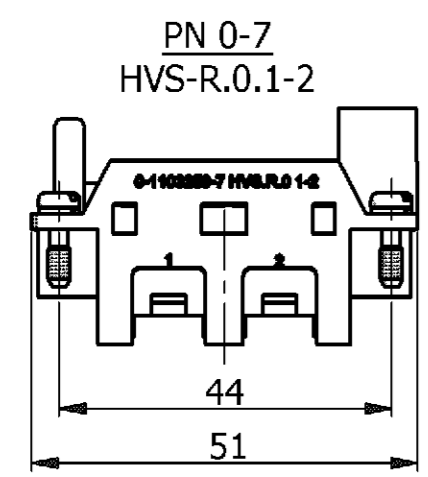
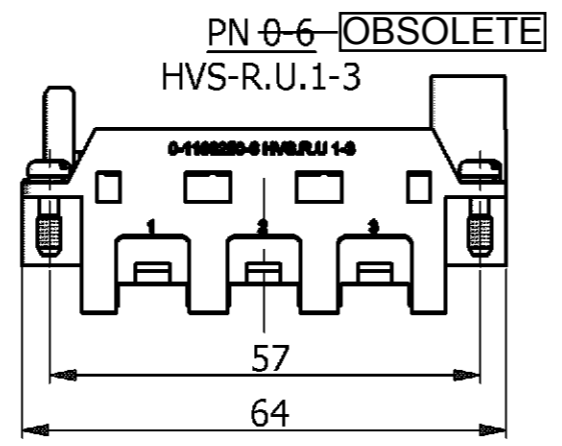
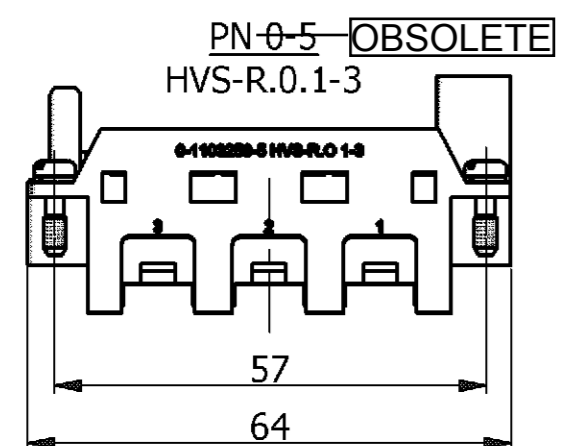
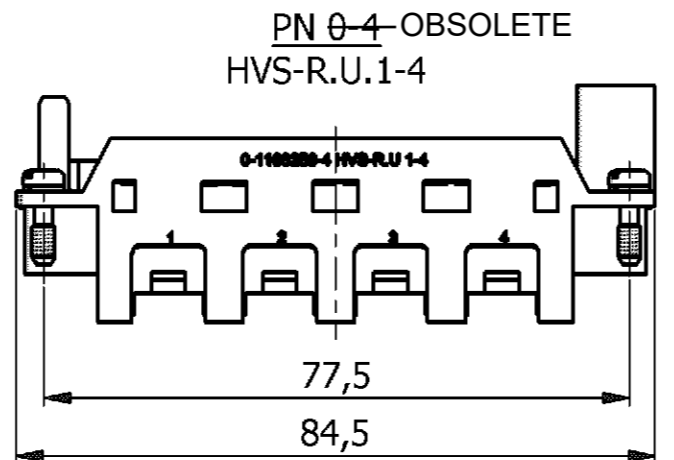
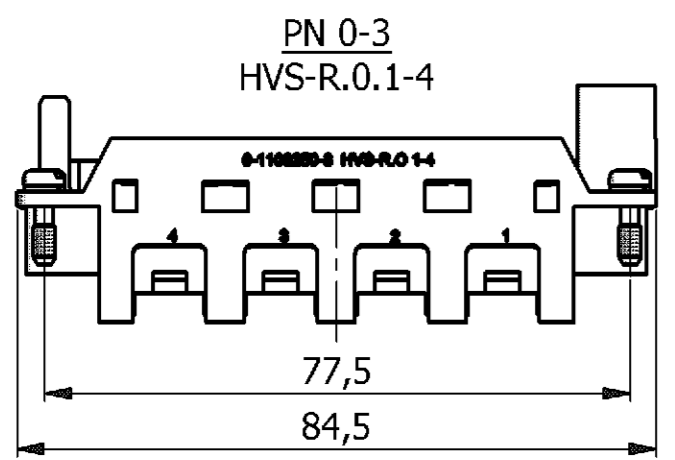
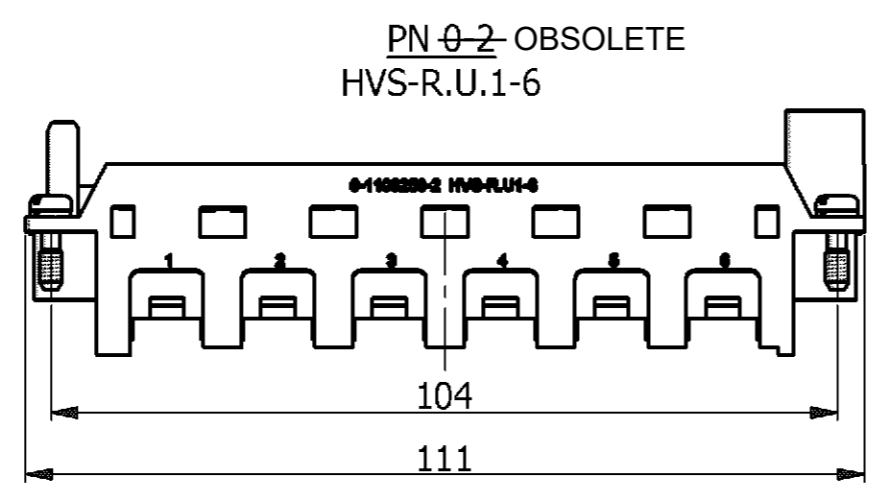
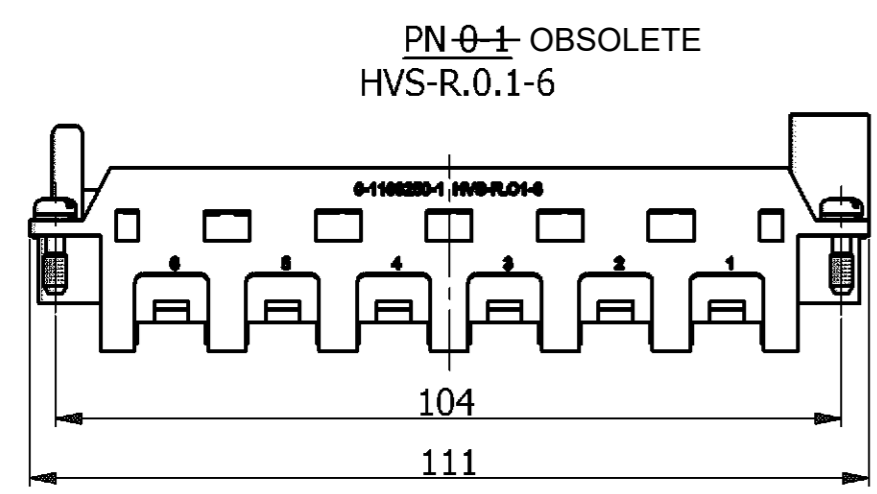

QTY.	DESCRIPTION	MATERIAL	SURFACE	COLOR	NOTE	ITEM
1	TORSION SPRING	STAINL. STEEL	---	---	DIA 6.6X0.5 - 2.5 WDG.	4
4	FIXING SCREW	STEEL	NICKEL PLATED	BLUE	M3X10,5	3
2	PAN HEAD SCREW	STEEL	NICKEL PLATED	---	M4*8	2
1	FRAME	ZINC	NICKEL PLATED	---	---	1

PARTS LIST

DWN	SCHNEIDER	16.02.2006	TE TE Connectivity	
CHK	H.BRAUN	17.02.2006		
APVD	T.SCHNURPFEL	17.02.2006	NAME	
PRODUCT SPEC.	108-74075	ASSY MODULE FRAME		
APPLICATION SPEC.	114-74080	SERIES HVS, SIZE 1-4		
WEIGHT	0,001 KG	SCALE	1:1	SHEET
CUSTOMER DRAWING / KUNDENZEICHNUNG		DRAWING NO.	1103250	RESTRICTED TO NUR FUER
		CAGE CODE	00779	1 OF 1
		REV.	B3	