

DO NOT SCALE FROM THIS PRINT

- NOTES:
1. MINIMUM CONTACT PUSHOUT: 1.5 LBS.
  2. FOR A 1 POSITION SINGLE ROW ALL SPACERS ARE TO BE TSW-XX-S.
  3. SPACERS SHALL BE ASSEMBLED AS SHOWN WITH SNAP GROOVES AWAY FROM SSW BODY.
  4. MAXIMUM ALLOWABLE BOW .003[0.08] INCH/INCH AFTER ASSEMBLY
  5. DO NOT USE DSB SPACER BODY FOR THIS OPTION.
  6. MAXIMUM CUT FLASH : .010[0.25]; MAXIMUM CUT FLASH ON TAIL SIDE: .020[0.51] NOT TO EXTEND BELOW STANDOFFS

ESQ-1XX-XX-X-X-XXX-XX-X-XX \*SEE NOTE 6

**CONTACT STYLE**  
 SQUARE TAIL: USE C-15-X-X  
 LOW INSERTION FORCE: C-60-X-X (SEE TABLE 1, SHT 2)

**NO. OF POSITIONS**  
 POSITIONS 01 THRU 36 (SEE FIG 1)  
 FOR A ONE POSITION SINGLE ROW SEE NOTE 2

**LEAD STYLE**  
 (SEE TABLE 1, SHT 2)

**PLATING SPECIFICATION**  
 -G: 20µ" GOLD IN CONTACT AREA, 3µ" GOLD TAIL  
 -T: MATTE TIN CONTACT AND TAIL  
 -S: 30µ" SELECTIVE GOLD IN CONTACT AREA, MATTE TIN TAIL  
 -H: 30µ" HEAVY GOLD IN CONTACT AREA, 3µ" GOLD TAIL  
 -L: 10µ" SELECTIVE LIGHT GOLD IN CONTACT AREA, MATTE TIN TAIL

**METAL WASHER OPTION**  
 #\* -H-MW: (SEE FIG 3, SHT 2) (N/A ON TRIPLE ROW) (.300 [7.62] MAX TAIL) (AVAILABLE ON POS -02 THRU -32 ONLY)

**LOCKING LEAD OPTION**  
 -LL (SEE FIG 2, SHT 2) (N/A ON 1 OR 2 POSITION SINGLE ROW)

**POLARIZATION OPTION**  
 INDICATES POSITION (SEE FIG 4, SHT 2)

**ROW SPECIFICATION** (SEE TABLE 1, SHT 2)  
 -S: SINGLE (USE SSW-50-S)  
 -D: DOUBLE (USE SSW-50-D)  
 -T: TRIPLE (USE SSW-50-T)

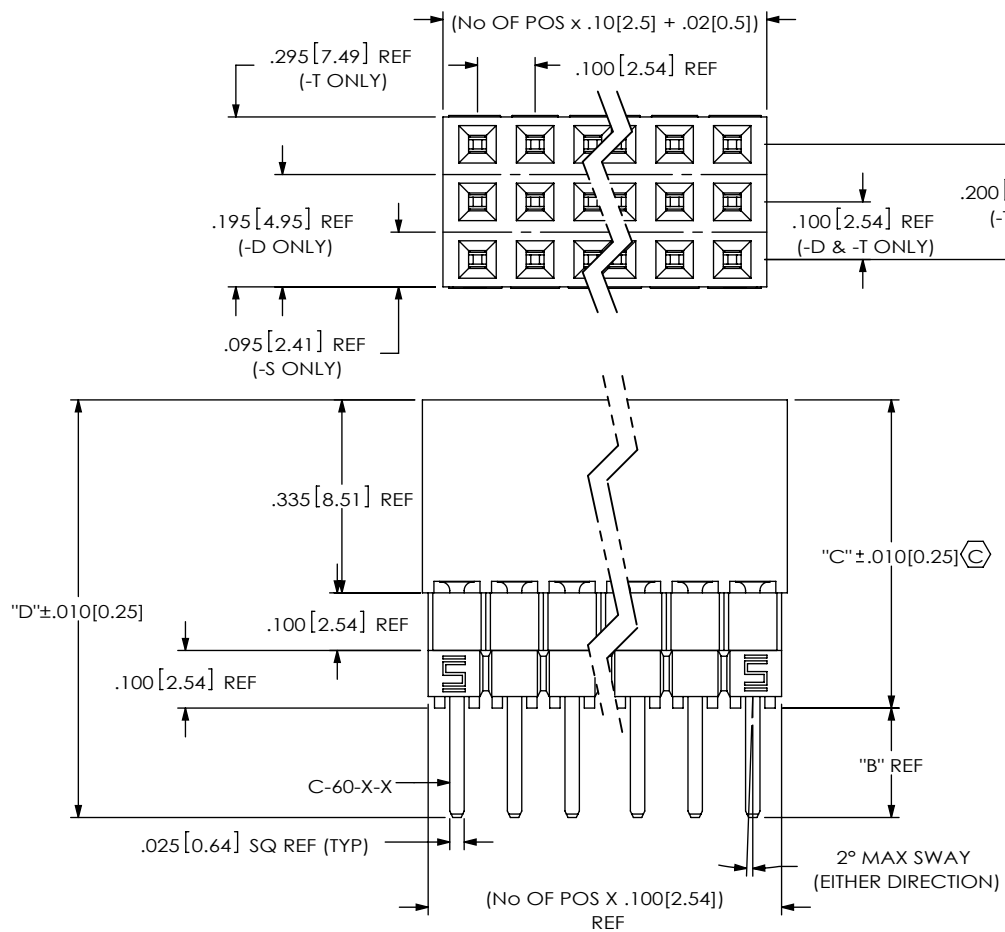

#-MW OPTION, DO NOT DESIGN IN. SAMTEC WILL ONLY SUPPORT EXISTING BUSINESS 2/12/02

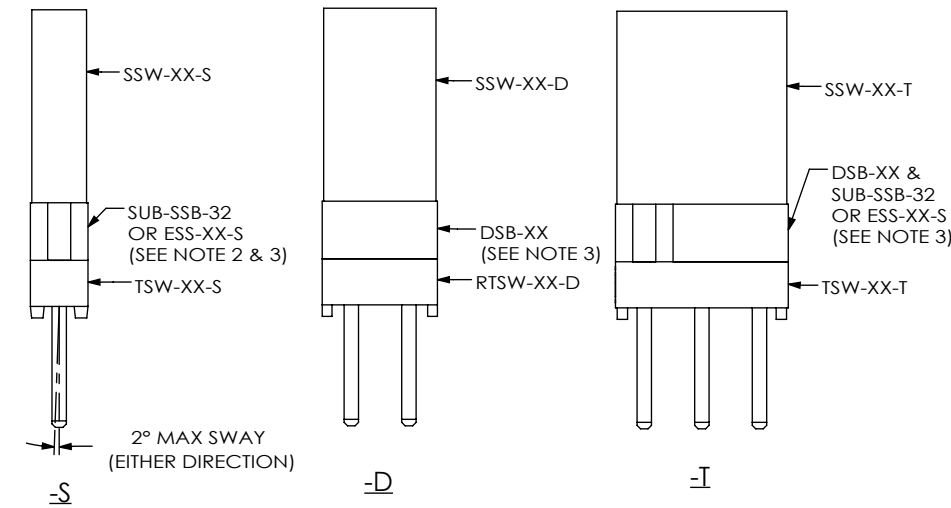

FIG 1  
ESQ-110-XX-X-T

UNLESS OTHERWISE SPECIFIED, DIMENSIONS ARE IN INCHES. TOLERANCES ARE:  
 DECIMALS ANGLES  
 .XX: ±.01 [0.3] 2°  
 .XXX: ±.005 [0.13]  
 .XXXX: ±.0020 [0.051]

**PROPRIETARY NOTE**  
 THIS DOCUMENT CONTAINS CONFIDENTIAL AND PROPRIETARY INFORMATION AND ALL DESIGN, MANUFACTURING, REPRODUCTION, USE, PATENT RIGHTS AND SALES RIGHTS ARE EXPRESSLY RESERVED BY SAMTEC, INC. THIS DOCUMENT SHALL NOT BE DISCLOSED, IN WHOLE OR PART, TO ANY UNAUTHORIZED PERSON OR ENTITY NOR REPRODUCED, TRANSFERRED OR INCORPORATED IN ANY OTHER PROJECT IN ANY MANNER WITHOUT THE EXPRESS WRITTEN CONSENT OF SAMTEC, INC.

**samtec**  
 520 PARK EAST BLVD, NEW ALBANY, IN 47150  
 PHONE: 812-944-6733 FAX: 812-948-5047  
 e-Mail info@SAMTEC.com code 55322

MATERIAL: DO NOT SCALE DRAWING SHEET SCALE: 3:1  
 INSULATOR: LCP, UL 94 V0  
 COLOR: BLACK  
 CONTACT : PHOS BRONZE

DESCRIPTION: ESQ STRIP ASM  
 DWG. NO. ESQ-1XX-XX-X-X-XXX-XX-X-XX

BY: JORDAN 7-16-85 SHEET 1 OF 4

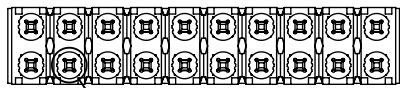

DETAIL A  
SCALE 4 : 1

ESQ-110-XX-X-D-MW-T  
.005 [0.13] MAX  
MEASURE AT  
THE TAIL

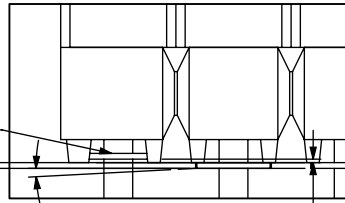

DETAIL B  
SCALE 6 : 1

3° MAX SWAY  
ANY DIRECTION

.003 [0.08] MAX  
MEASURE AT  
THE TAIL

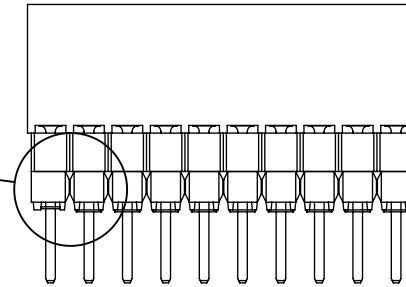
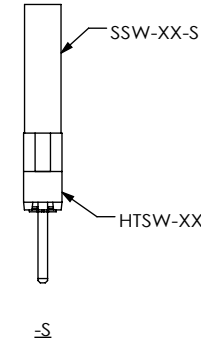

FIG 3

#-H-MW: METAL WASHER  
ESQ-110-XX-X-MWT  
(ONE PER POSITION)  
(-S & -D BODY SPECS ONLY)  
(SEE NOTE 5)

(SAME AS FIG 1 UNLESS OTHERWISE NOTED)



-S

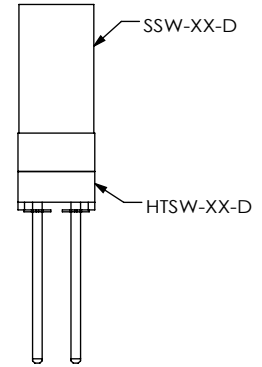

-D

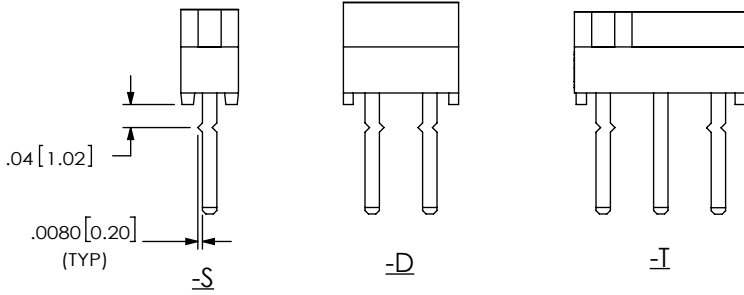
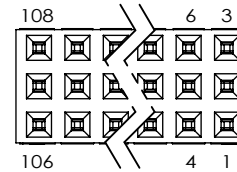

FIG 2

-LL: LOCKING LEAD OPTION  
LOCATED ON OR ABOUT CENTERLINE  
[N/A IN 1 OR 2 POSITION SINGLE ROW]

.04 [1.02]  
.0080 [0.20]  
(TYP)



-I

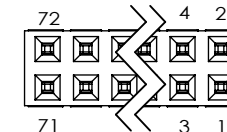

-D

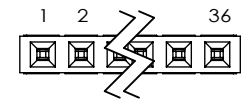

-S

FIG 4  
XXX: POLARIZATION LOCATION  
INSERT PK-06-N INTO SPECIFIED POS  
AND BREAK OFF TAB

F:\DWG\MISC\MKTG\ESQ-1XX-XX-X-XXX-XX-X-MKT.SLDDRW

STANDARD INSERTION FORCE	CONTACT	SPACER SPECIFICATION (FOR A ONE POSITION SINGLE SEE NOTE 3)			"B"	"C"	"D"	"E"
		ESQ-S	ESQ-D	ESQ-T				
		-12	C-15-2-X	N/A				
-13	C-15-3-X	N/A	N/A	N/A	.29[7.37]	.435[11.05]	.725[18.41]	N/A
-14	C-15-4-X	N/A	N/A	N/A	.48[12.2]	.435[11.05]	.915[23.24]	N/A
-23	C-15-3-X	(1) SUB-SSB-32	(1) DSB-XX	(1) SUB-SSB-32 (1) DSB-XX	.19[4.83]	.535[13.59]	.725[18.41]	N/A
-24	C-15-4-X	(1) SUB-SSB-32	(1) DSB-XX	(1) SUB-SSB-32 (1) DSB-XX	.38[9.65]	.535[13.59]	.915[23.24]	N/A
-33	C-15-3-X	(2) SUB-SSB-32	(2) DSB-XX	(2) SUB-SSB-32 (2) DSB-XX	.09[2.87]	.635[16.13]	.725[18.41]	N/A
-34	C-15-4-X	(2) SUB-SSB-32	(2) DSB-XX	(2) SUB-SSB-32 (2) DSB-XX	.28[7.11]	.635[16.13]	.915[23.24]	N/A
-44	C-15-4-X	(1) ESS-XX-S	(3) DSB-XX	(1) ESS-XX-S (3) DSB-XX	.18[4.57]	.735[18.67]	.915[23.24]	N/A
LOW INSERTION FORCE	CONTACT	SPACER SPECIFICATION (FOR A ONE POSITION SINGLE SEE NOTE 3)			"B"	"C"	"D"	"E"
		ESQ-S	ESQ-D	ESQ-T				
		-37	C-60-2-X	N/A				
-38	C-60-3-X	N/A	N/A	N/A	.29[7.37]	.435[11.05]	.725[18.41]	N/A
-39	C-60-4-X	N/A	N/A	N/A	.48[12.2]	.435[11.05]	.915[23.24]	N/A
-48	C-60-3-X	SUB-SSB-32	(1) DSB-XX	(1) SUB-SSB-32 (1) DSB-XX	.19[4.83]	.535[13.59]	.725[18.41]	N/A
-49	C-60-4-X	(1) SUB-SSB-32	(1) DSB-XX	(1) SUB-SSB-32 (1) DSB-XX	.38[9.65]	.535[13.59]	.915[23.24]	N/A
-58	C-60-3-X	(2) SUB-SSB-32	(2) DSB-XX	(2) SUB-SSB-32 (2) DSB-XX	.09[2.87]	.635[16.13]	.725[18.41]	N/A
-59	C-60-4-X	(2) SUB-SSB-32	(2) DSB-XX	(2) SUB-SSB-32 (2) DSB-XX	.28[7.11]	.635[16.13]	.915[23.24]	N/A
-69	C-60-4-X	(1) ESS-XX-S	(3) DSB-XX	(1) ESS-XX-S (3) DSB-XX	.18[4.57]	.735[18.67]	.915[23.24]	N/A

PROPRIETARY NOTE  
THIS DOCUMENT CONTAINS CONFIDENTIAL AND PROPRIETARY INFORMATION AND ALL DESIGN, MANUFACTURING, REPRODUCTION, USE, PATENT RIGHTS AND SALES RIGHTS ARE EXPRESSLY RESERVED BY SAMTEC, INC. THIS DOCUMENT SHALL NOT BE DISCLOSED, IN WHOLE OR PART, TO ANY UNAUTHORIZED PERSON OR ENTITY NOR REPRODUCED, TRANSFERRED OR INCORPORATED IN ANY OTHER PROJECT IN ANY MANNER WITHOUT THE EXPRESS WRITTEN CONSENT OF SAMTEC, INC.

DO NOT SCALE DRAWING

SHEET SCALE: 1:1

**samtec**

520 PARK EAST BLVD, NEW ALBANY, IN 47150  
PHONE: 812-944-6733 FAX: 812-948-5047  
e-Mail: info@SAMTEC.com code 55322

DESCRIPTION: ESQ STRIP ASM

DWG. NO. ESQ-1XX-XX-X-X-XXX-XX-X-XX

BY: WHITTAKER 9-11-98 SHEET 2 OF 4

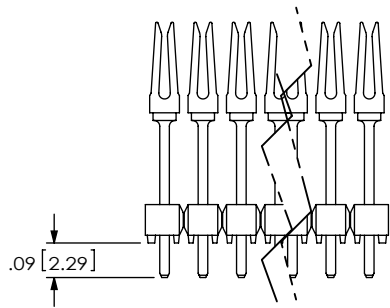

LOAD CONTACT

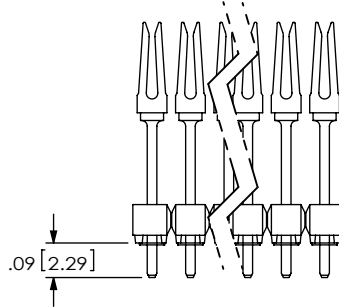

PRESS ON -MW

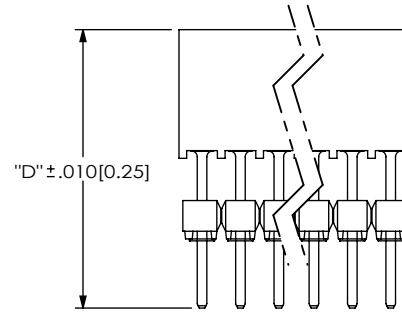

PRESS ON  
SSW BODY

IN-PROCESS  
-12, -33, -37, -58

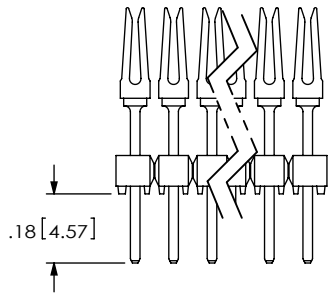

LOAD CONTACT

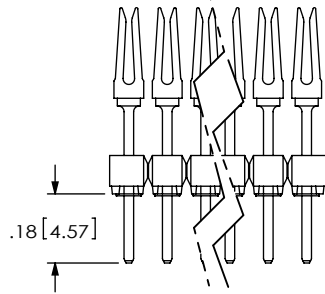

PRESS ON -MW

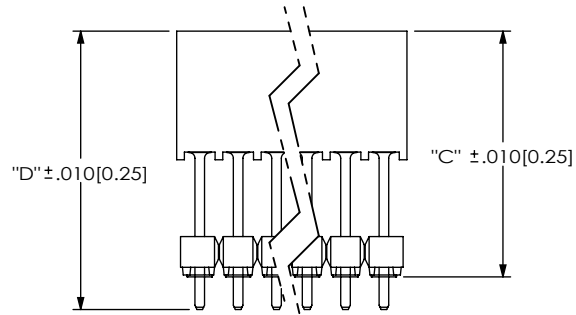

PRESS ON  
SSW BODY

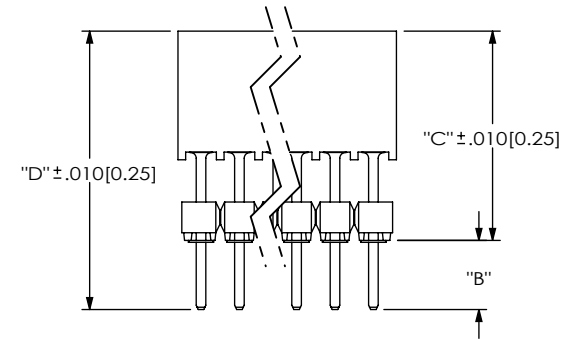

REPRESS STACKER BODY  
AND -MW TO PROPER "C" DIM

IN-PROCESS  
-13, -14, -23, -24, -34, -38  
-39, -44, -48, -49, -59, -69

PROPRIETARY NOTE  
THIS DOCUMENT CONTAINS CONFIDENTIAL AND PROPRIETARY INFORMATION AND ALL DESIGN, MANUFACTURING, REPRODUCTION, USE, PATENT RIGHTS AND SALES RIGHTS ARE EXPRESSLY RESERVED BY SAMTEC, INC. THIS DOCUMENT SHALL NOT BE DISCLOSED, IN WHOLE OR PART, TO ANY UNAUTHORIZED PERSON OR ENTITY NOR REPRODUCED, TRANSFERRED OR INCORPORATED IN ANY OTHER PROJECT IN ANY MANNER WITHOUT THE EXPRESS WRITTEN CONSENT OF SAMTEC, INC.

DO NOT SCALE DRAWING

SHEET SCALE: 1:1



520 PARK EAST BLVD, NEW ALBANY, IN 47150  
PHONE: 812-944-6733 FAX: 812-948-5047  
e-Mail info@SAMTEC.com code 55322

DESCRIPTION: ESQ STRIP ASM

DWG. NO. ESQ-1XX-XX-X-X-XXX-XX-X-XX

BY: WITHTKAKER 9-11-98 SHEET 3 OF 4

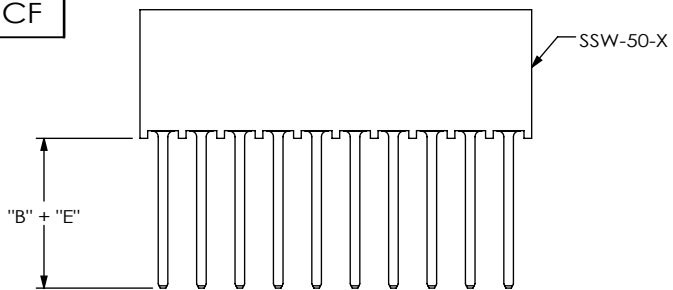

**STEP 1**  
MACHINE FILL SSW-50-X

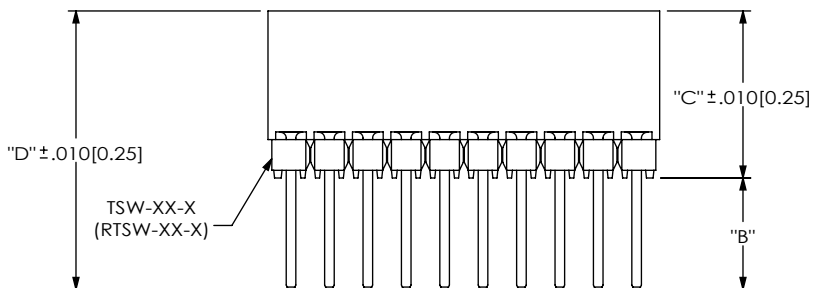

**STEP 2**  
MULTI-CUT TSW-50-X TO POS (RTSW-50-D FOR DOUBLE ROW)  
AND MOUNT AS SHOWN.  
(IF RTSW-50-D NOT AVAILABLE, TSW-50-D MAY BE USED)

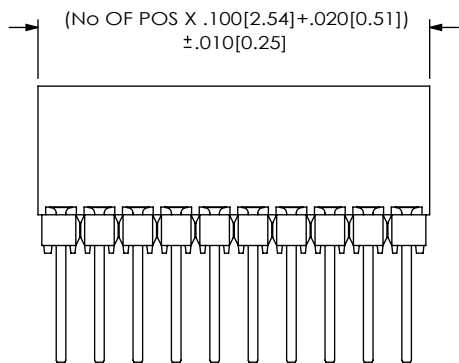

**STEP 3**  
ROTO CUT TO POS

**FIG 5**  
ESQ-110-XX-X-S  
IN PROCESS "B"  
(LEAD STYLE -12 & -37)  
(-S & -D ONLY)

TABLE 2			
LEAD STYLE	ROW	TUBE	PLUG (2)
-12, -13, -14, -37, -38, -39	-S	PT-ESQ002	TP-03
-23, -24, -48, -49		PT-ESQ001	TP-03
-33, -34, -44, -58, -59, -69		PT-1-24-01-47	TP-24
-12, -37	-D	PT-1-24-03-44	TP-07
-14, -24, -34, -44, -39, -49, -59, -69		PT-1-24-02-47	TP-07
-13, -23, -33, -38, -48, -58		PT-1-24-01-51	TP-13
-12, -37	-T	PT-1-24-01-51	TP-13
-13, -14, -23, -24, -33, -34, -44, -38, -39, -48, -49, -58, -59, -69		PT-1-24-03-51	TP-13

1. FOR -12 & -37 LEAD STYLES TUBE PAC KAGE -04 THRU -36 POSITION ONLY.
2. FOR -13, -23, -33, -38, -48, & -58 LEAD STYLES TUBE PACKAGE -08 THRU -36 POSITIONS ONLY.
3. FOR -14, -24, -34, -44, -39, -49, -59, & -69 LEAD STYLES -05 THRU -36 POSITIONS ONLY.

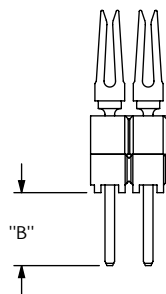

**FIG 6**  
ESQ-110-XX-X-D  
IN PROCESS "A"  
(LEAD STYLE -12-T, -13, -14, -23, -24, -33, -34, -44, -37-T, -38, -48, -49, -58, -59, -69)

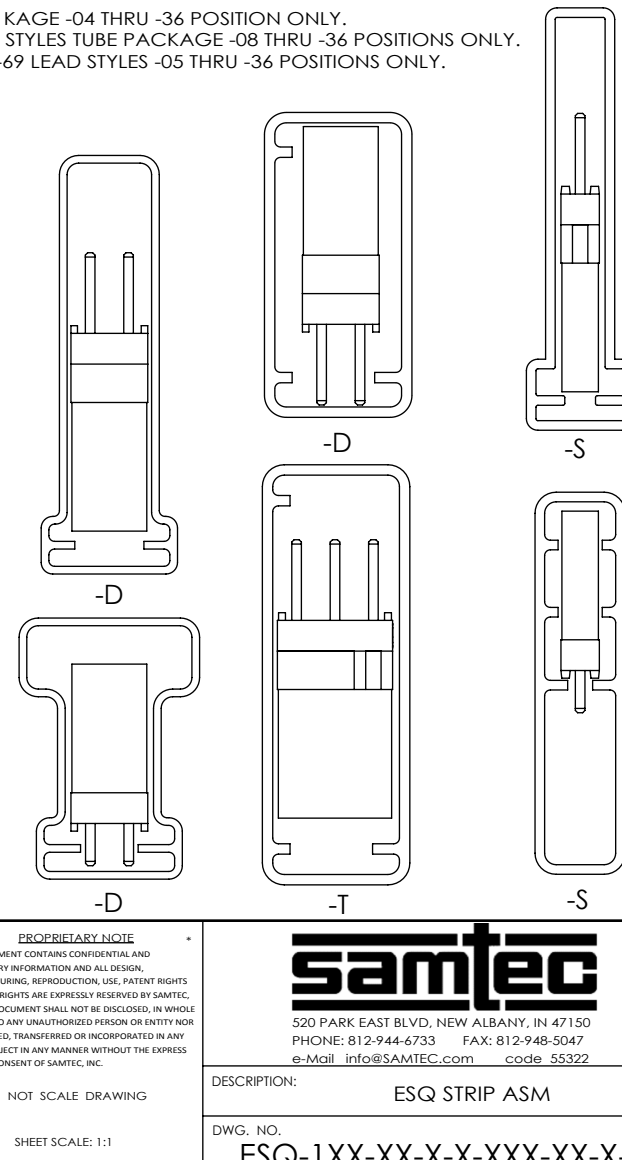

**PROPRIETARY NOTE**  
THIS DOCUMENT CONTAINS CONFIDENTIAL AND PROPRIETARY INFORMATION AND ALL DESIGN, MANUFACTURING, REPRODUCTION, USE, PATENT RIGHTS AND SALES RIGHTS ARE EXPRESSLY RESERVED BY SAMTEC, INC. THIS DOCUMENT SHALL NOT BE DISCLOSED, IN WHOLE OR PART, TO ANY UNAUTHORIZED PERSON OR ENTITY NOR REPRODUCED, TRANSFERRED OR INCORPORATED IN ANY OTHER PROJECT IN ANY MANNER WITHOUT THE EXPRESS WRITTEN CONSENT OF SAMTEC, INC.

DO NOT SCALE DRAWING

SHEET SCALE: 1:1

**samtec**  
520 PARK EAST BLVD, NEW ALBANY, IN 47150  
PHONE: 812-944-6733 FAX: 812-948-5047  
e-Mail info@SAMTEC.com code 55322

DESCRIPTION: ESQ STRIP ASM

DWG. NO. ESQ-1XX-XX-X-X-XXX-XX-X-XX

BY: WHITTAKER 9-11-98 SHEET 4 OF 4