

SUMMARY



Image is for illustrative purpose only

Wires

Low voltage 2

Series	0S
Termination type	Male solder
IP rating	50
AWG wire size	30.00 - 22.00
Cable Ø	3.80 - 4.40 mm
Status	active
Alternative part	FFA.0S.302.CLAC44
Matching parts	ERA.0S.302.CLL

Download

[Request a quote](#)

[Eplan](#)

[Catalog](#)

TECHNICAL DETAILS

Mechanics

Shell Style/Model	FFA*: Straight plug, cable collet
Keying	Hermaphroditic keying (half moon insert) with male pin 1
Housing Material	Brass (chrome plated [SAE AMS 2460]) shell and collet nut, nickel plated [SAE AMS QQ N 290] brass latch sleeve and mid pieces
Weight	7.82 g

Performance

Configuration	0S.302 : 2 Low Voltage
Insulator	L: PEEK (UL 94 / V-0/1.5)
Rated Current	10 Amps

Specifications

Contact Type: Solder
Contact Dia.: 0.9 mm (0.0354in)
Bucket Dia.: 0.8 mm (0.031in)
Max. Solid Conductor: 0.34 mm² (AWG 22)
R (max): 4.8 mOhm
Vtest: 1500 V (AC), 2100 V (DC)

Others

LEMO products and services are provided "as is". LEMO makes no warranties or representations with regard to LEMO product & services or use of them, express, implied or statutory, including for accuracy, completeness, or security. The user is fully responsible for his products and applications using LEMO components.

Endurance (Shell): 5000 mating cycles
 Temp (min / max): -55°C / +250°C
 Humidity (max): <=95% [at 60 deg C / 140 F]
 Vibration: 15 g [10 Hz - 2000 Hz]
 Shock Resistance: 100 g [6 ms]
 Climatical Category: 50/175/21
 Shielding (min): 75 dB (10 MHz)
 Shielding (min): 40 dB (1 GHz)
 Salt Spray Corrosion: >144 hr

DRAWINGS

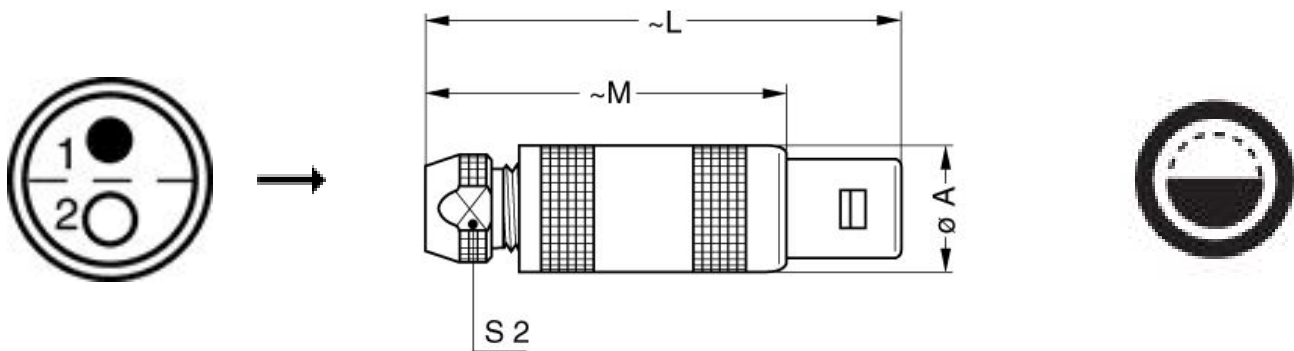

Dimensions

	A	L	M	S2
mm.	9	34.5	24.5	6.5
in.	0,35	1,36	0,96	0,26











RECOMMENDED BY LEMO

Tools

Spanner wrench: [DCD.05.005.PA065](#)

LEMO products and services are provided "as is". LEMO makes no warranties or representations with regard to LEMO product & services or use of them, express, implied or statutory, including for accuracy, completeness, or security. The user is fully responsible for his products and applications using LEMO components.

Cables

120250	PVC	Grey	
20140	PVC	Grey	
20140	PVC	Grey	
20142	PVC	Red	
20143	PVC	Green	
20144	PVC	Black	
20145	PVC	Yellow	
20146	PVC	Black	
20260	PVC	Black	
20264	PVC	Black	
20266	PVC	Violet	
2280	PVC	Black	

LEMO products and services are provided "as is". LEMO makes no warranties or representations with regard to LEMO product & services or use of them, express, implied or statutory, including for accuracy, completeness, or security. The user is fully responsible for his products and applications using LEMO components.