

## SUMMARY

### # Wires

Low	6
High	0
Coax	0
Triax	0
Quad	0
Fiber	0
Fluidic	0

Series	1B
Termination type	Male solder
IP rating	50
Cable Ø	5.30 - 6.20 mm
Status	active
Alternative part	
Matching parts	<a href="#">EGG.1B.306.CLL</a> <a href="#">PHG.1B.306.CLLD62</a>



Image is for illustrative purpose only

### Download

[Request a quote](#)

[Catalog](#)

[See video assembly instructions](#)

## TECHNICAL DETAILS

### Mechanics

Shell Style/Model	FG*: Straight plug, cable collet
Keying	1 key (alpha=0, plug: male contacts, receptacle: female contacts)
Housing Material	Brass (chrome plated) shell and collet nut, nickel plated brass latch sleeve and mid pieces
Variant	
Weight	15.07 g

### Performance

Configuration	1B.306 : 6 Low Voltage
Insulator	L: PEEK (UL 94 / V-0/1.5)
Rated Current	7 Amps

### Specifications

Contact Type: Solder
Contact Dia.: 0.7 mm (0.028in)
Bucket Dia.: 0.8 mm (0.031in)

LEMO products and services are provided "as is". LEMO makes no warranties or representations with regard to LEMO product & services or use of them, express, implied or statutory, including for accuracy, completeness, or security. The user is fully responsible for his products and applications using LEMO components.

Max. Stranded Conductor: 0.34 mm<sup>2</sup> (AWG 22)  
 Max. Conductor: 0.34 mm<sup>2</sup> (AWG 22)  
 R (max): 6.1 mOhm  
 Vtest (contact-shell): 1200 V (AC), 1700 V (DC)  
 Vtest (contact-contact): 1050 V (AC), 1490 V (DC)

## Others

Endurance (Shell): 5000  
 Temp (min / max): -55°C / +250°C  
 Humidity (max): ≤95% [at 60 deg C / 140 F]  
 Vibration: 15 g [10 Hz - 2000 Hz]  
 Shock Resistance: 100 g [ 6 ms]  
 Climatical Category: 50/175/21  
 Shielding (min): 75 dB (10 MHz)  
 Shielding (min): 40 dB (1 GHz)  
 Salt Spray Corrosion: >1000 hr  
 IP Rating: 50

## DRAWINGS

### Draws

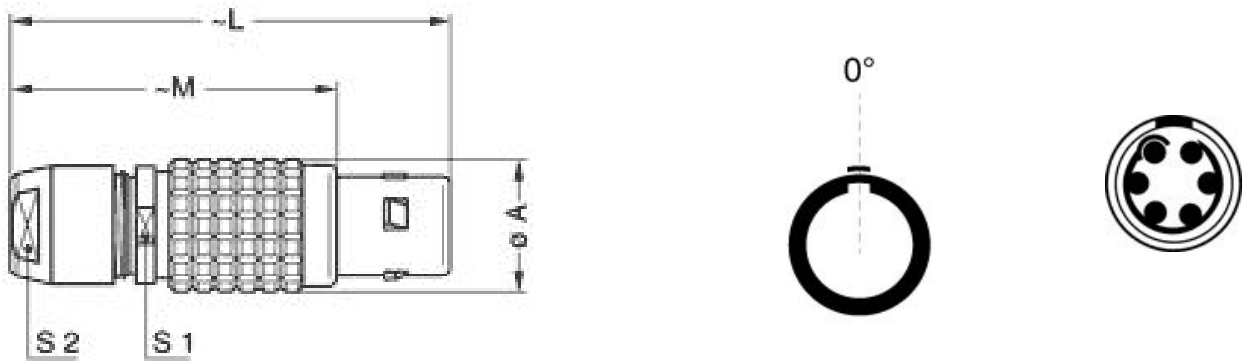

### Dimensions

	A	L	M	S1	S2
mm.	12	43	32	10	9
in.	0.47	1.69	1.26	0.39	0.35

LEMO products and services are provided "as is". LEMO makes no warranties or representations with regard to LEMO product & services or use of them, express, implied or statutory, including for accuracy, completeness, or security. The user is fully responsible for his products and applications using LEMO components.







# RECOMMENDED BY LEMO

## Tools

Spanner wrench: DCD.1B.015.PA090

Caps: BFG.1B.100.PCSG

## Cables

CMN.06.T22.055PGCE	PVC	GREY	
CMN.06.T22.055PGZE		Grey	
CMN.06.T22.055PNCE	PVC	Black	
CMN.06.T22.055PNZE			
012 080	PVC	Grey	
106 220	PVC	Black	
160 240	PVC	Black	
260 250	PVC	Grey	

LEMO products and services are provided "as is". LEMO makes no warranties or representations with regard to LEMO product & services or use of them, express, implied or statutory, including for accuracy, completeness, or security. The user is fully responsible for his products and applications using LEMO components.