



Operating instructions
Electronic level sensor

UK

LK10xx
LK70xx

11408955 / 00 08 / 2021

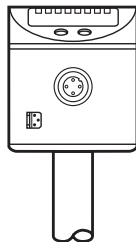

Contents

1 Preliminary note.....	4
1.1 Symbols used.....	4
2 Safety instructions	4
3 Functions and features	5
3.1 Application area	5
3.2 Restriction of the application area	5
4 Getting started	6
4.1 Example configuration 1	6
4.2 Example configuration 2	7
5 Function.....	8
5.1 Measuring principle	8
5.2 Operating principle / features of the unit.....	8
5.2.1 Operating modes	8
5.2.2 Notes on integrated overflow prevention	9
5.2.3 Display and switching functions.....	10
5.2.4 Offset for indicating the real level in the tank.....	11
5.2.5 Defined state in case of a fault	11
5.2.6 IO-Link function	11
6 Installation.....	12
6.1 Installation instructions for operation with overflow prevention	13
6.2 Installation instructions for operation without overflow prevention	14
6.2.1 Installation in the inactive zone.....	14
6.2.2 Installation in the active zone A of the probe	15
6.3 Other installation notes.....	16
6.3.1 Marking of the installation height	16
7 Electrical connection.....	17
8 Operating and display elements	18
9 Menu.....	19
9.1 Menu structure.....	19
10 Parameter setting	20
10.1 Parameter setting in general	20
10.2 Basic settings	21

10.2.1	Set unit of measurement [uni].....	21
10.2.2	Set offset [OFS].....	21
10.2.3	Set medium [MEdI].....	21
10.2.4	Set overflow prevention [OP].....	22
10.2.5	Adjust overflow prevention [cOP].....	22
10.3	Set output signals.....	24
10.3.1	Set output function [oux] for OUTx.....	24
10.3.2	Define switching limits [SPx] / [rPx] (hysteresis function).....	24
10.3.3	Define switching limits [FHx] / [FLx] (window function).....	24
10.3.4	Set switching delays [dSx] for the switching outputs.....	24
10.3.5	Set reset delay [drx].....	25
10.3.6	Define switching logic [P-n].....	25
10.3.7	Define response of the outputs in case of a fault [FOUx].....	25
10.3.8	Configure display [diS].....	25
10.3.9	Reset all parameters to factory settings [rES].....	25
11	Notes on parameter setting via IO-Link.....	26
12	Operation.....	27
12.1	Operation indication.....	27
12.2	Read set parameters.....	27
12.3	Error indications.....	28
12.4	Output response in different operating states.....	28
13	Technical data.....	29
13.1	Setting values [OFS].....	29
13.2	Setting values [OP].....	29
13.3	Calculation aids [OP].....	30
13.3.1	Definition "from the cover".....	30
13.3.2	Definition "from the bottom".....	31
13.4	Setting ranges [SPx] / [FHx] and [rPx] / [FLx].....	31
14	Maintenance / cleaning / change of medium.....	31
14.1	Maintenance information for operation without overflow prevention.....	32
15	Factory setting.....	33
16	Applications.....	34
16.1	Hydraulic tank.....	34
16.2	Pumping station.....	35
16.3	Storage tank.....	36

1 Preliminary note

1.1 Symbols used

- ▶ Instructions
- > Reaction, result
- [...] Designation of keys, buttons or indications
- Cross-reference



Important note

Non-compliance may result in malfunction or interference.



Information

Supplementary note.

2 Safety instructions

- The device described is a subcomponent for integration into a system.
 - The manufacturer of the system is responsible for the safety of the system.
 - The system manufacturer undertakes to perform a risk assessment and to create a documentation in accordance with legal and normative requirements to be provided to the operator and user of the system. This documentation must contain all necessary information and safety instructions for the operator, the user and, if applicable, for any service personnel authorised by the manufacturer of the system.
- Read this document before setting up the product and keep it during the entire service life.
- The product must be suitable for the corresponding applications and environmental conditions without any restrictions.
- Only use the product for its intended purpose (→ Functions and features).
- Only use the product for permissible media (→ Technical data).
- If the operating instructions or the technical data are not adhered to, personal injury and/or damage to property may occur.
- The manufacturer assumes no liability or warranty for any consequences caused by tampering with the product or incorrect use by the operator.

- Installation, electrical connection, set-up, operation and maintenance of the product must be carried out by qualified personnel authorised by the machine operator.
- Protect units and cables against damage.
- The unit complies with the standard EN 61000-6-4. The unit may cause radio interference in domestic areas. If interference occurs, the user must take appropriate actions.

3 Functions and features

3.1 Application area

The unit was especially designed to meet the requirements of machine tool building. It is particularly suitable for monitoring coolant emulsions (also dirty) as well as cutting and hydraulic oils.

3.2 Restriction of the application area

- The unit is not suitable for:
 - acids and alkalis
 - hygienic and electroplating applications
 - highly conductive and adhesive media (e.g. glue, shampoo)
 - granulates, bulk material
 - use in grinders (increased risk of formation of deposits).
- It is possible that foam of good conductivity is detected as level:
 - ▶ Check proper function by an application test.
- For water and hydrous media with temperatures $> 35\text{ °C}$, install the unit in a climatic tube (→ Accessories).
- For automatic medium detection (→ 5.2.1):
For media which are very inhomogeneous, separate from each other thus forming separation layers (e.g. oil layer on water) the following applies:
 - ▶ Check proper function by an application test.

4 Getting started

For fast set-up, the example configurations described in the following can be used for most applications. The indicated minimum distances apply exclusively to each separately described case.

4.1 Example configuration 1

Unit:	LK1022 (probe length $L = 264$ mm)
Medium to be detected:	Mineral oil
Operating mode:	Manual media selection with overflow prevention (factory setting LK10xx) (→ 5.2.1)
Installation environment:	Metal tank, installation to Fig. 4-1.

- ▶ Install unit.
- ▶ Observe the distances (x), (u) and (c):

x:	min. 4.0 cm
u:	min. 1.0 cm
c:	max. 14.0 cm

- ▶ Ground sensor and tank via an electrical connection (→ 7).
- ▶ Observe the parameter setting sequence:
 - [MED] = [OIL.2] (→ 10.2.3)
 - [OFS] = (u); e. g. (u) = 2.0 cm (→ 5.2.4)
 - [OP] = Set the overflow prevention OP at a distance (y) greater than 4.5 cm below the mounting element.

 For distances (y) smaller than 4.5 cm there may be malfunctioning and error messages during the adjustment process [cOP].

 Step increment and setting range: (→ 13.2)
Calculation aids for [OP]: (→ 13.3)

- ▶ Adjust overflow prevention OP to [cOP] (→ 10.2.5).
- > **The unit is ready for operation.**
- ▶ Make further settings if necessary.
- ▶ Check whether the unit operates correctly.

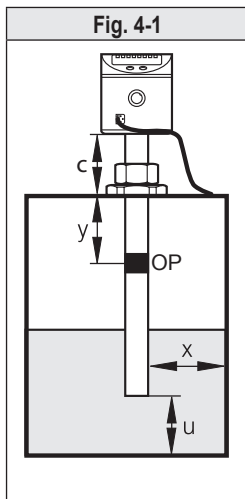

4.2 Example configuration 2

Unit	LK7023 (with factory setting); probe length L = 472 mm
Medium to be detected:	coolant emulsion
Operating mode:	automatic medium detection (factory setting LK70xx) (→ 5.2.1)
Installation environment:	metal tank, installation to Fig. 4-2

- ▶ Install unit.
- ▶ Observe the distances (x), (u) and (c):

x:	min. 4.0 cm
u:	min. 1.0 cm
c:	max. 23.0 cm

- ▶ Ground sensor and tank via an electrical connection (→ 7).
- ▶ Observe the maximum permitted level (b).

! A distance (a2) greater than 5.0 cm has to be observed between maximum level (b) and mounting element.

- ▶ Observe the parameter setting sequence:
 - [MEdl] = [Auto] (→ 10.2.3)
 - [OFS] = (u), e.g. (u) = 1.0 cm (→ 5.2.4)
 - [SP1] = Set the switch point at a distance (a2) greater than 5.0 cm below the mounting element.

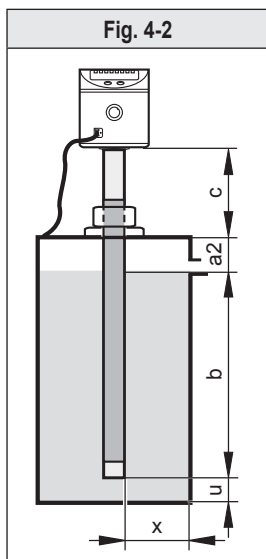

i Adjustable step increment 0.5 cm.
Switch point [SP1] is used as overflow prevention (pump off, close inlet, ...).

- ▶ **Unit must be reinitialised:**
- ▶ Switch the operating voltage off and on again.
- > **The unit is ready for operation.**
- ▶ Make further settings if necessary.
- ▶ Check whether the unit operates correctly.

5 Function

5.1 Measuring principle

The sensor determines the level according to the capacitive measuring principle:

- An electrical field [E] is generated and influenced by the medium to be detected. This change to the field causes a measurement signal that is electronically evaluated.
- The dielectric constant of a medium is important for its detection. Media with a high dielectric constant (e.g. water) generate a strong measurement signal, media with a low dielectric constant (e.g. oils) a correspondingly lower signal.
- The active measuring range of the sensor probe is composed of 16 capacitive measuring segments. They generate measurement signals depending on the degree of coverage.

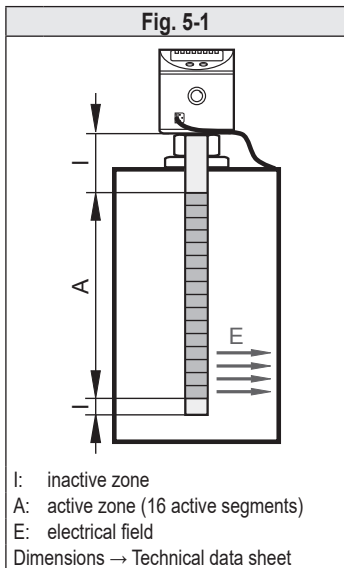

5.2 Operating principle / features of the unit

The unit can be installed in tanks of different sizes.

2 outputs are available. They can be set separately.

OUT1	switching signal for level limit / IO-Link
OUT2	switching signal for level limit

To adjust to the present application select the required operating mode.

5.2.1 Operating modes

1. **Manual media selection with overflow prevention (factory setting LK10xx)**
Recommended! Highest operational reliability!

The medium to be detected is set manually [MEdI]. In addition, an integrated, independently functioning overflow prevention is available.

2. Manual media selection without overflow prevention

Medium operational reliability!

The medium to be detected is set manually as described under 1. However, the overflow prevention is deactivated. For this reason, no adjustment is required.

3. Automatic medium detection (factory setting LK70xx)

Lowest operational reliability!

Each time the operating voltage is switched on, the unit adjusts itself to the medium and the installation environment.



For automatic media detection, **no** overflow prevention is available.

Automatic media detection can only function properly under certain conditions (e.g. compliance with special mounting specifications, restrictions for operation and maintenance).

5.2.2 Notes on integrated overflow prevention

With the parameter [OP] (OP = overflow prevention), one of the upper measuring segments is defined as integrated overflow prevention OP.

- If the overflow prevention OP is activated, an adjustment to the installation situation has to be made [cOP]. Otherwise, the unit is not ready for operation; [≡≡≡≡] is displayed until readiness (→ 12.1).
- The overflow prevention OP can be deactivated ([OP] = [OFF]).



Deactivating the overflow prevention OP can impair the operational reliability. For optimum operation and maximum operational reliability, we therefore recommend to **not** deactivate the overflow prevention OP.

- The overflow prevention OP is the maximum limit of the measuring range. The switch points [SPx] / [FHx] are always below [OP]!
- The overflow prevention OP is not assigned to a separate output! It offers additional protection and only switches if, as the level rises, one of the outputs has not switched even though the corresponding switch point has been exceeded (e.g. due to application-related malfunctions).

- Typically the overflow prevention OP reacts when the selected measuring segment has been reached (a few mm before the set OP value).
- The overflow prevention OP reacts immediately and without delay. The set delay times (e.g. of a switch point directly below) have no effect on the overflow prevention OP.
- The response of the overflow prevention OP is indicated on the display ("Full" and indication of the current level change every second).

5.2.3 Display and switching functions

The unit displays the current level, selectable in cm or inches. The display unit is defined by parameter setting. The set unit of measurement and the switching status of the outputs are indicated by LEDs.

The unit signals via two switching outputs (OUT1, OUT2) that a set limit has been exceeded or that the level is below the limit. The parameters of the switching outputs can be set.

- Hysteresis function / normally open (Fig. 5-2): $[oux] = [Hno]$.
- Hysteresis function / normally closed (Fig. 5-2): $[oux] = [Hnc]$.



First the set point [SPx] is set, then the reset point [rPx] with the requested difference.



The hysteresis for the overflow prevention OP is fixed.

- Window function / normally open (Fig. 5-3): $[oux] = [Fno]$.
- Window function / normally closed (Fig. 5-3): $[oux] = [Fnc]$.



The width of the window can be set by means of the difference between [FHx] and [FLx]. [FHx] = upper value, [FLx] = lower value.

Fig. 5-2

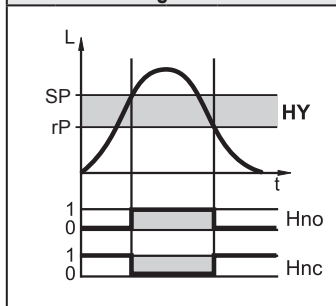

L: level

HY: hysteresis

Fig. 5-3

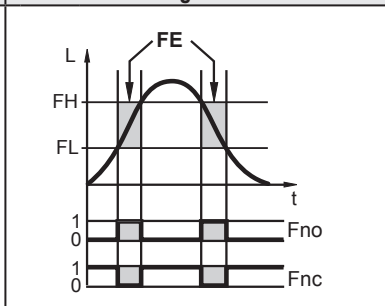

FE: window

5.2.4 Offset for indicating the real level in the tank

The zone between tank bottom and lower edge of the probe can be entered as offset value [OFS]. So display and switch points refer to the actual level (point of reference = tank bottom).



For [OFS] = [0]: The reference point is the lower edge of the measuring probe.



The set offset only refers to the display on the unit. It has no effect on the process value transmitted via IO-Link. The OFS parameter, however, is correctly transmitted via IO-Link and can therefore be taken into account. More information (→ 5.2.6).

5.2.5 Defined state in case of a fault

In case of a fault, a state can be defined for each output. If a fault is detected or if the signal quality is below a minimum value, the outputs pass into a defined state. For this case the response of the outputs can be set via the parameters [FOU1], [FOU2] (→ 10.3.7).

5.2.6 IO-Link function

This unit has an IO-Link communication interface which enables direct access to process and diagnostic data.

In addition it is possible to set the parameters of the unit while it is in operation. Operation of the unit via an IO-Link interface requires an IO-Link capable module (IO-Link master).

With a PC, suitable IO-Link software and an IO-Link adapter cable communication is possible when the system is not in operation.

The IODDs necessary for the configuration of the unit, detailed information about process data structure, diagnostic information, parameter addresses and the necessary information about the required IO-Link hardware and software can be found at www.ifm.com.

6 Installation

Fig. 6-1

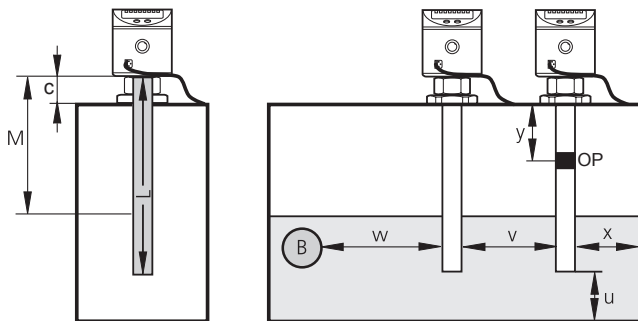

L: probe length
M: zone for mounting elements
c: maximum outside length

u ... y: minimum distances
OP: overflow prevention
B: metal object inside the tank

Table 6-1

	LKx022		LKx023		LKx024	
	[cm]	[inch]	[cm]	[inch]	[cm]	[inch]
L (rod length)	26.4	10.4	47.2	18.6	72.8	28.7
M (mounting zone)	14.0	5.5	23.0	9.1	36.0	14.2
c (max. outside length)*						

* Applies to installation as shown (wall thickness of the tank lid was neglected; mounting element does not protrude inside the tank).

Otherwise note mounting zone M.

6.1 Installation instructions for operation with overflow prevention

[MEdl] = [CLW..] or [OIL..]

[OP] = [value ...] (overflow prevention OP activated)



It is permitted to fix the mounting elements within the mounting zone (M) (Fig. 6-1).

- ▶ Adhere to the maximum permitted outside length (c) according to Table 6-1.
- ▶ Observe the minimum distances according to Fig. 6-1 and Table 6-2.
- ▶ Observe the notes on the integrated overflow prevention OP.



The overflow prevention OP must:

1. be below the mounting element.
2. be set at a minimum distance (y) to it.

The minimum distance is measured between the lower edge of the mounting element and the OP value.

Table 6-2

	MEdl = CLW.1		MEdl = CLW.2, OIL.1		MEdl = OIL.2	
	[cm]	[inch]	[cm]	[inch]	[cm]	[inch]
x	2.0	0.8	3.0	1.2	4.0	1.6
u	1.0	0.4	1.0	0.4	1.0	0.4
y (LKx022)	2.5	1.0	3.5	1.4	4.5	1.8
y (LKx023)	4.5	1.8	5.5	2.2	6.5	2.6
y (LKx024)	6.0	2.4	7.0	2.8	8.0	3.2
v	4.5	1.8	4.5	1.8	4.5	1.8
w	4.0	1.6	5.0	2.0	6.0	2.4



Calculation aids for [OP] (→ 13.3)

6.2 Installation instructions for operation without overflow prevention

[MEdI] = [Auto] or [OP] = [OFF] (overflow prevention OP deactivated)

6.2.1 Installation in the inactive zone



Between the maximum level (b1) and the inactive zone (I1), the minimum distance (a1) has to be adhered to (see Fig. 6-2 and Table 6-3)!

- ▶ Fix the unit using mounting elements in the inactive zone (I1). The outside length (c) must not exceed (I1) (see Table 6-3).
- ▶ Ensure that the maximum level (b1) is not exceeded after completed installation (see Table 6-3).
- ▶ Observe further minimum distances according to Table 6-4.

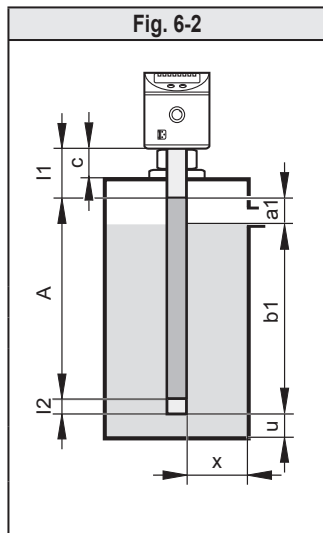

I1 / I2: inactive zones

A: active zone

a1: minimum distance between the inactive zone (I1) and the maximum level (b1)

b1: max. level from the lower edge of the sensor (without offset)

c: outside length
(max. outside length Table 6-1)

Table 6-3

	LKx022		LKx023		LKx024	
	[cm]	[inch]	[cm]	[inch]	[cm]	[inch]
I1	5.3	2.1	6.0	2.4	10.4	4.1
A	19.5	7.7	39.0	15.4	58.5	23.0
a1	1.0	0.4	1.5	0.6	2.5	1
b1	20.0	7.9	39.5	15.6	59.5	23.4

6.2.2 Installation in the active zone A of the probe



The minimum distance (a_2) between maximum level (b_2) and mounting element has to be observed (see Fig. 6-3 and Table 6-4)!

- ▶ Fix mounting elements in the mounting zone (M) (Fig. 6-1). Adhere to the maximum permitted outside length (c) (see Table 6-1).
- ▶ Ensure that the maximum level (b_2) is not exceeded after completed installation:
- ▶ $(b_2) = (L) - (c) - (a_2)$ (without offset).
- ▶ Observe further minimum distances according to Table 6-4.

- c : outside length
(max. outside length Table 6-1)
- a_2 : minimum distance between mounting element and maximum level (b_2)
- b_2 : max. level from the lower edge of the sensor

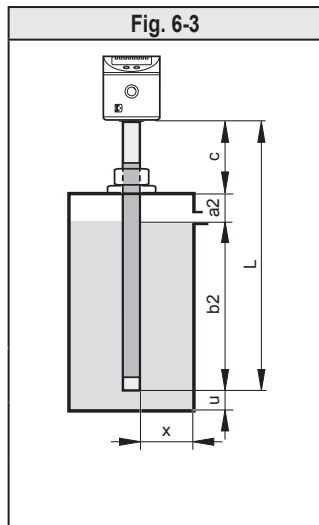

Table 6-4

	MEdl = CLW.1		MEdl = CLW.2, OIL.1		MEdl = OIL.2 / Auto	
	[cm]	[inch]	[cm]	[inch]	[cm]	[inch]
x	2.0	0.8	3.0	1.2	4.0	1.6
u	1.0	0.4	1.0	0.4	1.0	0.4
a2 (LKx022)	2.0	0.8	2.5	1.0	3.0	1.2
a2 (LKx023)	4.0	1.6	4.5	1.8	5.0	2.0
a2 (LKx024)	6.0	2.4	7.0	2.8	8.0	3.2
v *)	4.5	1.8	4.5	1.8	4.5	1.8
w *)	4.0	1.6	5.0	2.0	6.0	2.4

*) → Fig. 6-1.



In case of automatic medium detection [MEdI] = [Auto] or deactivated overflow prevention [OP] = [OFF], the sensor reinitialises itself each time it is switched on and makes adjustments to the medium and the installation environment. The active zone / measuring range must **not** be completely covered by the medium. The indicated minimum distances ensure this. Too short a distance may lead to maladjustments and malfunctions.

6.3 Other installation notes

- For mounting in plastic pipes / plastic tanks, the inside (pipe) diameter must at least be 12.0 cm (4.8 inches). Install sensor in the centre.
- For mounting in metal pipes the inside pipe diameter (d) must be at least:

	MEdI = CLW.1		MEdI = CLW.2, OIL.1		MEdI = OIL.2 / Auto	
	[cm]	[inch]	[cm]	[inch]	[cm]	[inch]
d	4.0	1.6	6.0	2.4	10.0	4.0

6.3.1 Marking of the installation height

- ▶ Fix the set installation height with the supplied stainless steel tube clip.

If the sensor is removed from the fixture for maintenance reasons, the clip serves as a limit stop when remounting the sensor. Thus an inadvertent maladjustment of the sensor is excluded. This is in particular necessary for the correct function of the overflow prevention OP.

- ▶ Fit the stainless steel tube clip using pliers.
- ▶ Ensure a safe fit.
- ▶ To remove the clip it has to be destroyed.

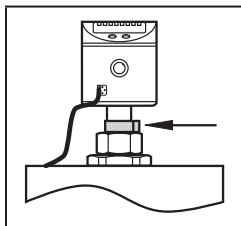

7 Electrical connection



The unit must be connected by a qualified electrician.

The national and international regulations for the installation of electrical equipment must be adhered to.

Voltage supply according to EN 50178, SELV, PELV.

► Disconnect power.

► Connect the unit as follows:

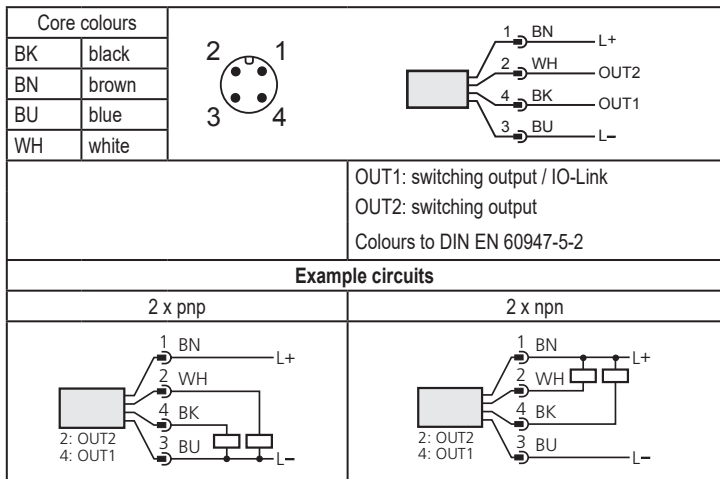

UK



For reliable function, the sensor housing must be electrically connected to the counter-electrode (grounding).

► Use the housing connection (see drawing) and a short piece of cable with a core cross-section of at least 1.5 mm².

When using metal tanks, the tank wall serves as the machine earth.

For plastic tanks, a counter-electrode must be provided, e.g. a metal plate inside the tank in parallel with the probe. Adhere to minimum distances to the probe.

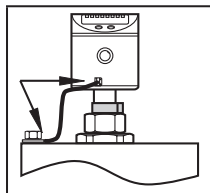

8 Operating and display elements

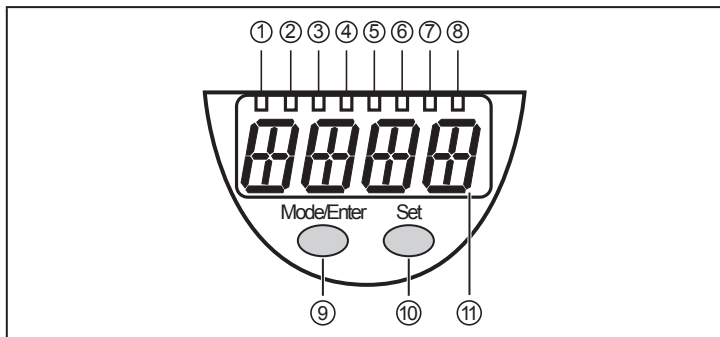

1 to 8: Indicator LEDs	
LED 1	indication in centimetres
LED 2	indication in inches
LEDs 3 - 6	not used
LED 7	switching status OUT2 (on if output 2 is switched)
LED 8	switching status OUT1 (on if output 1 is switched)
9: [Mode/Enter] button	
- selection of the parameters and acknowledgement of the parameter values	
10: [Set] button	
- setting of the parameter values (continuously by holding pressed, incrementally by pressing once)	
11: Alphanumeric display, 4 digits	
- display of the current level	
- display of the parameters and parameter values	
- display of the operating and fault indication	

9 Menu

9.1 Menu structure

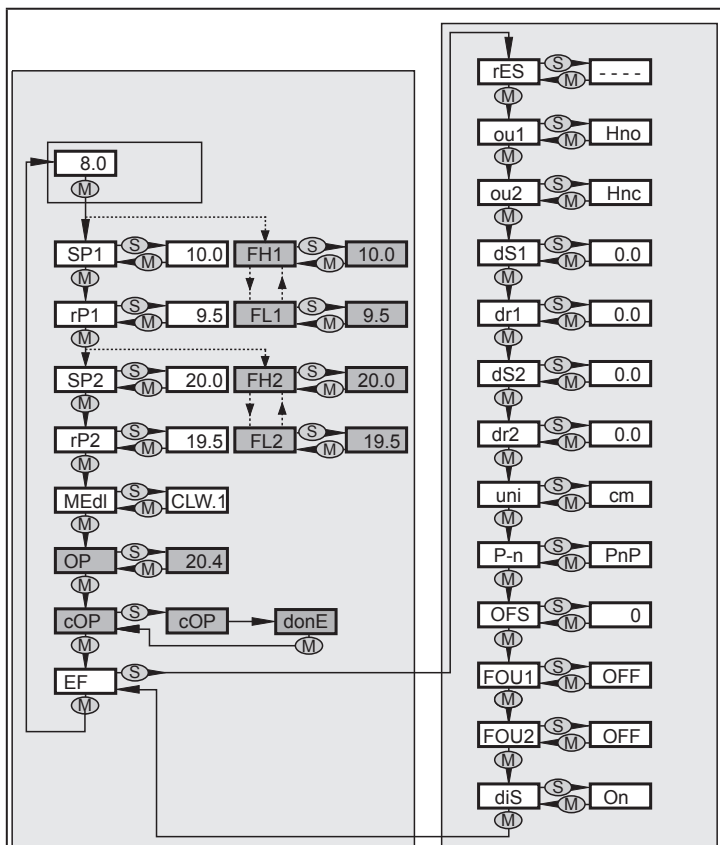





Menu items highlighted in grey, e.g. **[cOP]**, are only active when assigned parameters have been selected.

UK

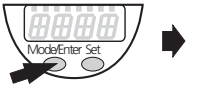
10 Parameter setting

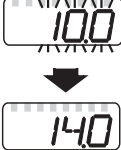
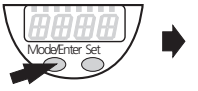
10.1 Parameter setting in general

1			<ul style="list-style-type: none">▶ Press [Mode/Enter] until the required parameter is displayed. To select parameters in the extended menu (menu level 2): <ul style="list-style-type: none">▶ Select [EF] and briefly press [Set].
2			<ul style="list-style-type: none">▶ Press and hold [Set]. > The current parameter value flashes for 5 s. <ul style="list-style-type: none">> Value is increased* (step by step by pressing the button once or continuously by keeping the button pressed).
3			<ul style="list-style-type: none">▶ Briefly press [Mode/Enter] (= confirmation). > The parameter is displayed again; the new parameter value becomes effective.
4	Change more parameters: <ul style="list-style-type: none">▶ Start again with step 1.		Finishing the parameter setting: <ul style="list-style-type: none">▶ Wait for 30 s or press and hold [Mode/Enter]. > The current measured value is displayed. <ul style="list-style-type: none">▶ Release [Mode/Enter]. > The parameter setting is finished.

*) Decrease the value: Let the display move to the maximum setting value. Then the cycle starts again at the minimum setting value.

Timeout: If no button is pressed for 30 s during programming, the unit returns to the operating mode with unchanged values (exception: cOP).

Locking / unlocking: The unit can be locked electronically to prevent unauthorised setting (factory setting: not locked).

▶ Make sure that the unit is in the normal operating mode.

To lock the unit:

▶ Press both buttons simultaneously for 10 s.

> [Loc] is displayed.

To unlock the unit:

▶ Press both buttons simultaneously for 10 s.

> [uLoc] is displayed.



The unit can be configured before or after installation.

Exception: To adjust the overflow prevention [cOP], the unit **must** be installed in the tank.

10.2 Basic settings

Setting ranges of all parameters: (→ 13)

Factory settings of all parameters: (→ 15)

10.2.1 Set unit of measurement [uni]



▶ Enter [uni] before entering the values for SPx, rPx, OP or OFS.

This avoids unintentional wrong settings.

▶ Select [uni]. ▶ Determine unit of measurement: [cm], [inch].	uni
---	------------

10.2.2 Set offset [OFS]

The zone between tank bottom and lower edge of the measuring probe can be entered as offset value (→ 5.2.4).



▶ Set [OFS] before entering the values for SPx, rPx or OP.

This avoids unintentional wrong settings.

▶ Select [OFS]. ▶ Set the value for the offset. Note the set unit of measurement [uni].	OFS
--	------------

10.2.3 Set medium [MEd]

▶ Select [MEd] and set the corresponding sensitivity: [CLW.1] = water, hydrous media, coolant emulsions [CLW.2] = water, hydrous media, coolant emulsions for temperatures > 35 °C (installation in climatic tube) [OIL.1] = oils with an increased dielectric constant (e.g. some synthetic oils) [OIL.2] = oils with a low dielectric constant (e.g. mineral oils) [Auto] = automatic medium detection	MEdI
---	-------------

▶ In case of doubt, select [OIL.2] for oils.

▶ Check proper function by an application test!



The settings [CLW.1] and [CLW.2] suppress deposits (e.g. metal swarf).
The settings [OIL.1] and [OIL.2] suppress a bottom layer of higher dielectric water or swarf which is a few cm high. If no oil layer is present (or if it is very thin), the bottom layer is detected.

With the setting [MEdl] = [Auto], **no** overflow prevention OP is available. In that case, the menu items [OP] and [cOP] are not available.

10.2.4 Set overflow prevention [OP]

<ul style="list-style-type: none"> ▶ Comply with minimum distances and installation instructions. ▶ Select [OP]. ▶ Define the position of the overflow prevention OP. <p>The option [OP] = [OFF] deactivates the overflow prevention OP.</p>	OP
--	-----------



- ▶ Set [OP] before [SPx] or [FHx].
- > [SPx] / [FHx] decreases if [OP] is reduced to a value \leq [SPx] / [FHx] after setting [SPx] / [FHx].
- > If [OP] is increased, [SPx] / [FHx] also increases if [OP] and [SPx] / [FHx] are close together (1 x step increment).



If the overflow prevention is deactivated [OP] = [OFF] or [MEdl] = [Auto], the reliable function of the sensor must be verified with particular care. Switch-on and switch-off processes and special operating states such as very full tanks, possible maintenance and cleaning operations are to be considered in the verification.



For the setting [OP] = [OFF], the menu item [cOP] is not available.

10.2.5 Adjust overflow prevention [cOP]

Only adjust the overflow prevention OP when the unit is installed. If possible, carry out the adjustment when the tank is empty.



- ▶ The tank may be partly filled.
- ▶ Make sure that the overflow prevention OP is **not** covered by the medium. Observe the minimum distance between the overflow prevention OP and the level (→ Table10-1).

<ul style="list-style-type: none"> ▶ Select [cOP]. ▶ Press [SET] and keep it pressed. > [cOP] flashes for some seconds; then the continuous display indicates that the adjustment is being made. > If the adjustment is successful, [donE] is displayed. ▶ Confirm with [Mode/Enter]. > If the adjustment is not successful, [FAIL] is displayed. ▶ Possibly lower the level or correct the position of the overflow prevention [OP] and repeat the adjustment operation. 	cOP
---	------------

Minimum distance between the overflow prevention OP and the level during adjustment:

Table 10-1		
	[cm]	[inch]
LKx022	2.0	0.8
LKx023	3.5	1.4
LKx024	5.0	2.0

 The position of the overflow prevention OP can be determined by calling up the parameter [OP]. Note the offset if necessary.

The current level is to be determined manually since the unit is not yet ready for operation before the adjustment.

 When the overflow prevention is activated ([OP] = [value]), an adjustment [cOP] must be carried out each time:

- [MEdI] or [OP] was changed. In this case ≡≡≡≡ is displayed.
- The installation position (height, orientation) was changed.
- The connection between the sensor and the tank ground (e.g. cable length) was changed.

 With deactivated overflow prevention [OP] = [OFF] or [MEdI] = [Auto]: To apply the basic settings and to adapt to the medium and installation environment the unit has to be reinitialised **when installed**.

- ▶ Switch the operating voltage off and on again.

10.3 Set output signals

10.3.1 Set output function [oux] for OUTx

<ul style="list-style-type: none">▶ Select [oux] and adjust the switching function: [Hno] = hysteresis function / normally open [Hnc] = hysteresis function / normally closed [Fno] = window function / normally open [Fnc] = window function / normally closed <p>If the switching output is used as an overflow prevention, the setting [oux] = [Hnc] (NC function) is recommended. The principle of normally closed operation ensures that wire break or cable break is also detected.</p>	ou1 ou2
---	--------------------------

10.3.2 Define switching limits [SPx] / [rPx] (hysteresis function)

<ul style="list-style-type: none">▶ Make sure that the function [Hno] or [Hnc] is set for [oux].▶ First set [SPx], then [rPx].▶ Select [SPx] and set the value at which the output is set.	SP1 SP2
<ul style="list-style-type: none">▶ Select [rPx] and set the value at which the output is reset.	rP1 rP2

[rPx] is always smaller than [SPx]. The unit only accepts values which are lower than the value for [SPx]. If [SPx] is shifted, [rPx] also shifts provided that the lower end of the setting range is not reached.

10.3.3 Define switching limits [FHx] / [FLx] (window function)

<ul style="list-style-type: none">▶ Make sure that the function [Fno] or [Fnc] is set for [oux].▶ First set [FHx], then [FLx].▶ Select [FHx] and set the upper limit of the acceptable range.	FH1 FH2
<ul style="list-style-type: none">▶ Select [FLx] and set the lower limit of the acceptable range.	FL1 FL2

[FLx] is always lower than [FHx]. The unit only accepts values which are lower than the value for [FHx]. If [FHx] is shifted, [FLx] also shifts provided that the lower end of the setting range is not reached.

10.3.4 Set switching delays [dSx] for the switching outputs

<ul style="list-style-type: none">▶ Select [dSx] and set the value between 0.0 and 60 s. <p>The switching delay reacts according to VDMA.</p>	dS1 dS2
---	--------------------------

10.3.5 Set reset delay [drx]

<p>▶ Select [drx] and set the value between 0.0 and 60 s. The switch-off delay reacts according to VDMA.</p>	dr1 dr2
--	--------------------------

10.3.6 Define switching logic [P-n]

<p>▶ Select [P-n] and set [PnP] or [nPn].</p>	P-n
---	------------

10.3.7 Define response of the outputs in case of a fault [FOUx]

<p>▶ Select [FOUx] and set value: [On] = output switches ON in case of a fault [OFF] = output switches OFF in case of a fault A fault is for example: defective hardware, signal quality too low. Overflow is not considered to be a fault (→ 12.3).</p>	FOU1 FOU2
--	----------------------------

10.3.8 Configure display [diS]

<p>▶ Select [diS] and set value: On The display is switched on in the operating mode. Update of the measured values every 500 ms. [OFF] = The display is switched off in the operating mode. When one of the buttons is pressed, the current measured value is displayed for 30 s. The indicator LEDs remain active even if the display is deactivated.</p>	diS
---	------------

10.3.9 Reset all parameters to factory settings [rES]

<p>▶ Select [rES]. ▶ Press and hold [Set] until [----] is displayed. ▶ Briefly press [Mode/Enter]. > The unit reboots and the factory settings are restored.</p>	rES
---	------------

11 Notes on parameter setting via IO-Link



On delivery the LK10xx-type unit is not operational.

First, the integrated overflow prevention OP has to be adjusted.

Depending on the application, OP adjustment can be carried out in different ways:

- directly on the display (→ 10).
- via an IO-Link tool (e.g. LR DEVICE), button "Teach_OP [cOP]".
- via the controller: write the value 208 to the IO-Link index 2 (length: 1 byte).



The OP adjustment is not part of the data storage.

Therefore, a simple replacement (e.g. in case of a unit failure) is only possible with reservations: On the new unit, the OP adjustment has to be carried out manually, either via the operating keys or via IO-Link. Only when the OP adjustment has been carried out successfully does the unit revert to the cyclical process data transmission.



After a factory reset (button "Restore Factory Settings"), the device reboots and the factory settings are restored.

12 Operation

After switch-on of the operating voltage, the unit is in the operating mode (= normal operating mode). It carries out its measurement and evaluation functions and generates output signals according to the set parameters.

- ▶ Check whether the unit operates correctly.

12.1 Operation indication

[----] (continuous)	Initialisation phase after power on
[numerical value] + LED 1	Current level in cm
[numerical value] + LED 2	Current level in inches
LED 7 / LED 8	Switching status OUT2 / OUT1 (on if output x is switched)
[----]	Level below the active zone
[FULL] + [numerical value] alternately	The overflow prevention OP is reached (overflow warning) or the level is above the active zone.
≡≡≡≡	Adjustment [cOP] of the overflow prevention OP necessary.
[Loc]	Unit locked via buttons; parameter setting is not possible. For unlocking press the two setting buttons for 10 s.
[uLoc]	Unit is unlocked / parameter setting is possible again.
[C.Loc]	The unit is temporarily locked. Parameter setting via IO-Link is active (temporary locking).
[S.Loc]	Unit is permanently locked via software. This locking can only be removed with a parameter setting software.

UK

12.2 Read set parameters

- ▶ Briefly press [Mode/Enter] (if required, repeat several times).
- > Menu structure is scrolled until the required parameter has been reached.
- ▶ Briefly press [Set].
- > Respective parameter value is displayed for 30 s.

12.3 Error indications

	Possible cause	Recommended measures
[Err]	Fault in the electronics	► Replace the unit.
[SEnS]	<ul style="list-style-type: none"> • Interfering sources (e.g. EMC) • Faulty wiring • Problems with the supply voltage 	<ul style="list-style-type: none"> ► Check electrical connection. ► Check the connection between the sensor and the tank ground.
[FAIL]	Error during adjustment of the overflow prevention OP: <ul style="list-style-type: none"> • overflow prevention covered by the medium during adjustment • overflow prevention soiled • minimum distances too short • mounting element detected below the overflow prevention • measured value not constant 	<ul style="list-style-type: none"> ► Lower the level, if possible. ► Clean the probe. ► Observe the notes on installation. ► Correct the position of the overflow prevention OP. ► Repeat the adjustment. ► Deactivate OP (→ 5.2.2).
[SC1] + LED 8 [SC2] + LED 7	Flashing: short circuit in switching output OUT1 or OUT2	► Remove the short circuit.
[SC] + LED 7 + LED 8	Flashing: short circuit in both switching outputs	► Remove the short circuit.
[PARA]	Faulty data set	► Reset to factory settings [rES].

12.4 Output response in different operating states

	OUT1	OUT2
Initialisation phase	OFF	OFF
Overflow prevention OP not adjusted	OFF	OFF
Overflow prevention OP adjusted or deactivated, normal operation	according to the level and [ou1] setting	according to the level and [ou2] setting
Fault	OFF for [FOU1] = [OFF] ON for [FOU1] = [On]	OFF for [FOU2] = [OFF] ON for [FOU2] = [On]

13 Technical data



Technical data and scale drawing at www.ifm.com.

13.1 Setting values [OFS]

	[cm]		[inch]	
Setting range	0...200.0		0...78.8	
	LKx022 LKx023	LKx024	LKx022 LKx023	LKx024
Step increment	0.5	1	0.2	0.5

13.2 Setting values [OP]

LKx022		LKx023		LKx024	
[cm]	[inch]	[cm]	[inch]	[cm]	[inch]
20.4	8.0	40.7	16.0	61	23.9
19.1	7.5	38.3	15.1	57	22.4
17.9	7.1	35.8	14.1	53	21.0
16.7	6.6	33.4	13.1	50	19.5
15.5	6.1	31.0	12.2	46	18.1
14.3	5.6	28.5	11.2	42	16.7
13.0	5.1	26.1	10.3	39	15.2
11.8	4.7	23.6	9.3	35	13.8
10.6	4.2	21.2	8.3	31	12.3
9.4	3.7	18.8	7.4	28	10.9
8.2	3.2	16.3	6.4	24	9.5
6.9	2.7	13.9	5.5	20	8.0

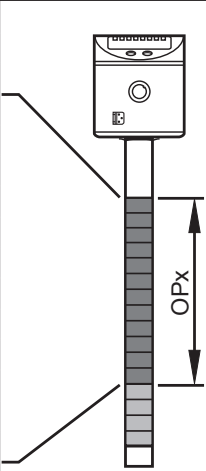

OPx: setting range [OP]

UK



The indicated values for [OP] refer to the distance between OP and the lower edge of the probe. The values apply if [OFS] = [0].

If [OFS] > [0], they increase by the set offset value.

Example LK1022: According to Table 12-2, OP has to be set to segment 20.4 cm.

[OFS] = 7.0 cm

[OP] is to be set to 20.4 cm + 7.0 cm = 27.4 cm.

13.3 Calculation aids [OP]



For proper functioning of the overflow prevention OP, a minimum distance (y) (Fig. 12-1) must be observed (→ 6.1).

The following applies (Fig. 12-1):

<p>B + c = L + u and B = z + y</p>	<p>B: tank height c: outside length (maximum (→ 6)) y: required response level OP from the cover (minimum (→ 6.1), maximum (→ 13.2))</p>	<p>L: probe length u: distance between probe and tank bottom z: required response level OP from the bottom (maximum: $z < L - c - y$ or $z < B - y$)</p>
--	--	--

13.3.1 Definition "from the cover"

Required distance (y) of the overflow prevention OP "from the cover" is defined.

- Without offset ([OFS] = [0]): $[OP] = L - c - y$
- With offset ([OFS] = u): $[OP] = L - c - y + u$
or
 $[OP] = B - y$

Example:

$c = 3.0$ cm, $y = 5.0$ cm, $u = 1.0$ cm

Without offset: $[OP] = 26.4$ cm - 3.0 cm - 5.0 cm
= 18.4 cm

With offset: $[OP] = 26.4$ cm - 3.0 cm - 5.0 cm + 1.0 cm
= 19.4 cm

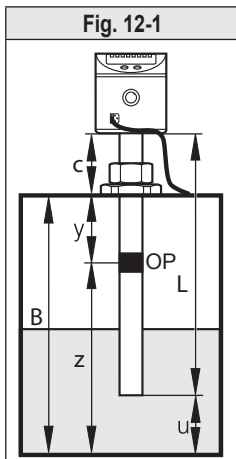

13.3.2 Definition "from the bottom"

Response level (z) of the overflow prevention OP from the tank bottom is defined.

- Without offset ([OFS] = [0]): [OP] = z - u
- With offset ([OFS] = u): [OP] = z

Example:

z = 18.0 cm (from the tank bottom), u = 1.0 cm

Without offset: [OP] = 18.0 cm - 1.0 cm = 17.0 cm

With offset: [OP] = 18.0 cm

Round the calculated value to the next lower adjustable value (→ 12.2).

13.4 Setting ranges [SPx] / [FHx] and [rPx] / [FLx]

	LKx022		LKx023		LKx024	
	[cm]	[inch]	[cm]	[inch]	[cm]	[inch]
[SPx] / [FHx]	2.5...20.0	1.0...7.8	3.5...39.0	1.4...15.4	6...59	2.5...23.5
[rPx] / [FLx]	2.0...19.5	0.8...7.6	3.0...38.5	1.2...15.2	5...58	2.0...23.0
Step increment	0.5	0.2	0.5	0.2	1	0.5



The values apply if [OFS] = [0].

If [OFS] > [0], they increase by the set offset value.

14 Maintenance / cleaning / change of medium

When removing or installing the unit for maintenance and cleaning:

- ▶ Make sure that the stainless steel tube clip is fixed to the sensor.
- > It must be possible to exactly reproduce the installation height and position!
- ▶ Remove the sensor and clean it / carry out maintenance
- ▶ Install sensor exactly in the same position as before.
- ▶ Otherwise check the parameter [OP] and carry out [cOP] once again.

14.1 Maintenance information for operation without overflow prevention

[MEdI] = [Auto] or = [OFF] (overflow prevention OP deactivated)

The unit must be reinitialised in the following cases (switch the operating voltage briefly off and on again):

- after all maintenance operations.
- after cleaning operations (e.g. water jet cleaning of the sensor probe).
- if the sensor was removed from the tank and then installed again during operation.
- if the active zone of the sensor was touched with the hand or grounded objects (e.g. a screwdriver, a cleaning lance).
- if the connection between the sensor and the tank wall / counter-electrode was changed.
- after a change of the medium with considerably differing dielectric constants.
For manual selection of media, first the [MEdI] setting needs to be adjusted.

15 Factory setting

	Factory setting			User settings
	LKx022	LKx023	LKx024	
SP1	10.0	19.5	29	
rP1	9.5	19.0	28	
SP2	20.0	39.0	59	
rP2	19.5	38.5	58	
OP*	20.4	40.7	61	
MEdl	LK10xx: CLW.1 LK70xx: Auto			
cOP	----			
rES	----			
ou1	Hno			
ou2	Hnc			
dS1	0.0			
dr1	0.0			
dS2	0.0			
dr2	0.0			
uni	cm			
P-n	PnP			
OFS	0			
FOU1	OFF			
FOU2	OFF			
diS	On			

* Not available / inactive for LK70xx

UK

16 Applications

16.1 Hydraulic tank

Minimum level monitoring with early warning and alarm

Switching output 1: early warning	
SP1	slightly above rP1 (to suppress wave movements)
rP1	below preset level → early warning, start refilling
ou1	hysteresis function, normally closed (Hnc)
Switching output 2: alarm	
SP2	min. value reached again → alarm reset
rP2	below min. value → alarm
ou2	hysteresis function, normally open (Hno)

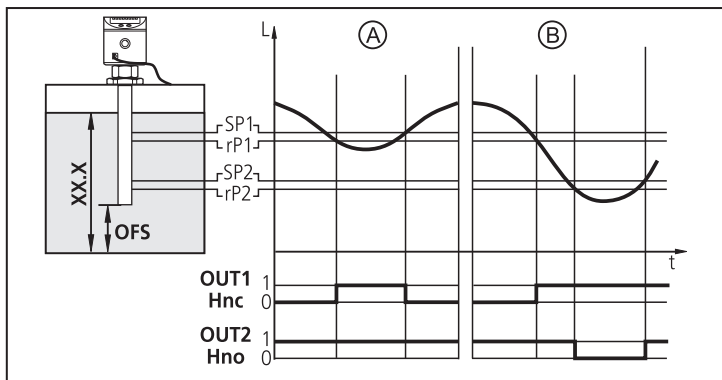

XX.X = display value

A = early warning, B = alarm

- If the level is below rP1, output 1 switches until liquid is refilled. If SP1 is reached again, output 1 switches off.
- If the level is above SP2, output 2 switches. If the level falls below rP2 or if there is a wire break, output 2 switches off.
- By setting SP1 the maximum level can be controlled / monitored: The value of SP1 determines up to which level (max) is to be refilled. When the maximum level is reached, this is signalled by the LED OUT1 going out and output 1 switching off.

16.2 Pumping station

Empty the tank with overflow prevention

Switching output 1: control to empty tank	
SP1	upper value exceeded → submersible pump ON
rP1	lower value reached → submersible pump OFF
ou1	hysteresis function, normally open (Hno)
Switching output 2: overflow prevention (for the LK10xx, it is recommended to use the integrated overflow prevention (parameter [OP]))	
SP2	maximum value exceeded → alarm
rP2	slightly below SP2 (to suppress wave movements)
ou2	hysteresis function, normally closed (Hnc)
OP	overflow prevention *)

UK

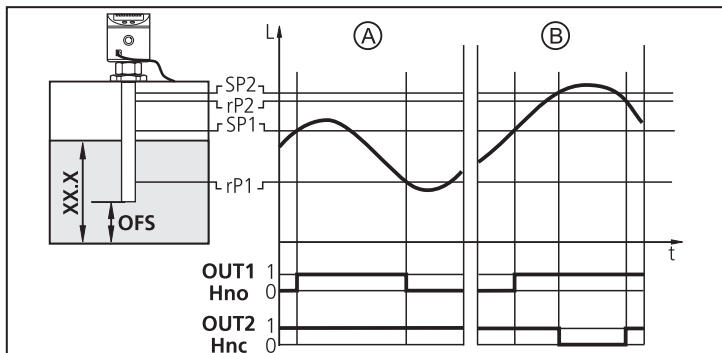

XX.X = display value

A = empty, B = overflow prevention

- If SP1 is exceeded, output 1 switches (submersible pump ON). If the level is below rP1 again, output 1 switches off (submersible pump OFF).
- If SP2 is exceeded or if there is a wire break, output 2 switches off.

*) It is recommended to use the integrated overflow prevention (parameter [OP]). If SP2 is set to the maximum value, the response of the overflow prevention (OP) leads to a switching operation immediately and without delay. In that case, SP2 functions as a directly acting overflow switch point.

16.3 Storage tank

Monitoring of the acceptable range (alarm) and level control

Switching output 1: refilling	
SP1	upper preset value reached → finish refilling
rP1	below lower preset value → start refilling
ou1	hysteresis function, normally closed (Hnc)
Switching output 2: safety function min - max	
SP2	max. value exceeded → alarm
rP2	below min. value → alarm
ou2	window function, normally open (Fno)

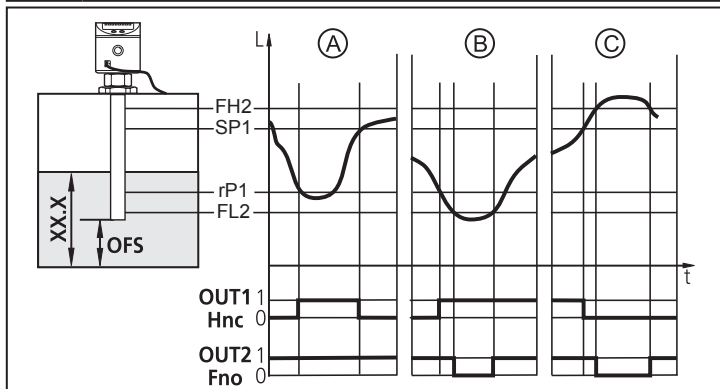

XX.X = display value

A = refill; B = min. monitoring; C = max. monitoring

- If the level is below rP1, output 1 switches until liquid is refilled. If SP1 is reached again, output 1 switches off.
- If the level is below FL2 or above FH2 or if there is a wire break, output 2 switches OFF (→ alarm).
- The logical operation between the outputs 1 and 2 indicates whether there is overflow or the actual level is below the minimum level.
 - Overflow: output 1 and output 2 switched off.
 - Below min. value: output 1 switched ON and output 2 switched OFF.

More information at www.ifm.com