

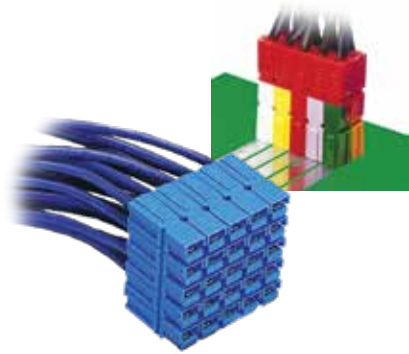

# Powerpole® Connectors

PP15/45 - Up to 55 Amps



PP15/45 series are the smallest Powerpole® housings. They can be used for wire-to-wire or wire-to-board applications. Wire sizes from 20 to 10 AWG (0.75 to 6 mm<sup>2</sup>) offer power capabilities up to 55 amps per pole. Finger proof housings and the ability to incorporate first-mate last-break ground connectors enhance the capabilities of the Powerpole® series.

- High Power Density**  
*Up to 55 amps in a compact footprint*
- Wire-to-Wire & Wire-to-Board Configurations**  
*Wire & PCB contacts can be used in the same housings*
- Finger Proof Housings Available**  
*Protects against accidental contact with live circuits*

## PP15/45 ORDERING INFORMATION

### PP15/45 Finger Proof Housings

Improved on the original design by adding ribs to mating interface to protect against accidental contact with live circuits. Meets the requirements of UL1977 section 10.2 and is rated IP20. Will not mate with standard housings.

Description	Part Numbers	
Minimum Quantity	2,500	200
Red	1327FP-BK	1327FP
Green	1327G5FP-BK	1327G5FP
Black	1327G6FP-BK	1327G6FP
White	1327G7FP-BK	1327G7FP
Blue	1327G8FP-BK	1327G8FP
Yellow	1327G16FP-BK	1327G16FP

### Finger Proof, Standard & Ground Housing Dimensions

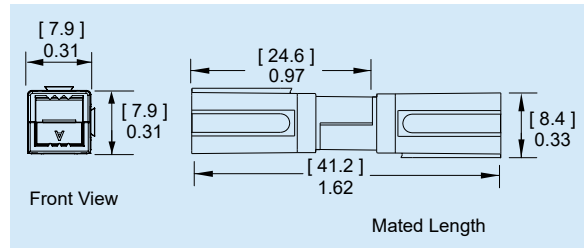

### PP15/45 Standard Housings

This original housing design has an open interface and is available in a wide array of colors. Will not mate with finger proof housings.

Description	Part Numbers	
Minimum Quantity	2,500	200
Red	1327-BK	1327
Green	1327G5-BK	1327G5
Black	1327G6-BK	1327G6
White	1327G7-BK	1327G7
Blue	1327G8-BK	1327G8
Yellow	1327G16-BK	1327G16
Orange	1327G17-BK	1327G17
Gray	1327G18-BK	1327G18
Brown	1327G21-BK	1327G21
Pink	1327G22-BK	1327G22
Purple	1327G23-BK	1327G23

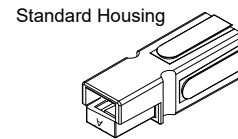
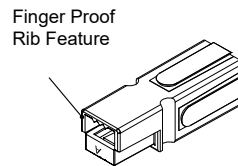

## PP15/45 Chemical Resistant (CR) Housings

Has the same form and dimensions of the standard PP15/45 housing in a chemical resistant PBT / PC blend housing.

Description	Part Numbers
Minimum Quantity	2,500
Red	P1327-BK
Gray	P1327G18-BK
Black	P1327G6-BK
Black	P1327G6FP
Black	P1327G6FP-BK
White	P1327G7-BK

Standard Housing

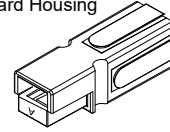

## 45A Premate Ground Housings - for use with ground contacts only

Will mate with standard Powerpole® housings.

Description	Part Numbers
Minimum Quantity	2,500 200
Green	1827G1-BK 1827G1

Premate Ground  
Open Front

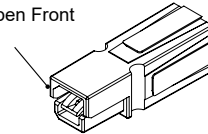

## PP15/45 Tin Plated Power Contacts

Offer cost effective performance up to 1,500 mating cycles. See specifications and temperature charts for amperage ratings by wire size.

Barrel	AWG	mm <sup>2</sup>	Mating Force	Loose Piece Part Numbers	Reeled Part Numbers	Dimensions - A -	
						inches	mm
Minimum Quantity				200	5,000		
Open	14 to 10 K *	2.1 to 5.3	High	269G3-LPBK	269G3	0.21	5.33
Open	14 to 10 K *	2.1 to 5.3	Low	261G2-LPBK	261G2	0.20	5.08
Open	14 to 10 SF *	2.1 to 6.0	High	201G1H-LPBK	201G1H	0.24	6.10
Open	14 to 10 SF *	2.1 to 6.0	Low	200G1L-LPBK	200G1L	0.24	6.10
Open	16 to 12	1.3 to 3.3	High	269G1-LPBK	269G1	0.18	4.57
Open	16 to 12	1.3 to 3.3	Low	261G1-LPBK	261G1	0.18	4.57
Open	20 to 16	0.52 to 1.3	High	269G2-LPBK	269G2	0.16	4.06
Open	20 to 16	0.52 to 1.3	Low	262G1-LPBK	262G1	0.16	4.06

K\* - For #10 AWG class K stranded wire or smaller. For larger wires use superflex contacts.  
SF\*- Indicates wires with high stranding such as Super Flex.

Open Barrel Contact

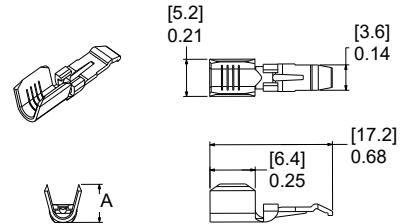

## PP15/45 Silver Plated Power Contacts

Maximize performance by offering up to 10,000 mating cycles and are recommended for circuit interrupt or hot plug applications. See specifications and temperature charts for amperage ratings by wire size. Only closed barrel contacts are suitable for soldering.

Barrel	AWG	mm <sup>2</sup>	Mating Force	Loose Piece Part Numbers	Reeled Part Numbers	Dimensions - A - - B -				
						inches	mm	inches	mm	
Minimum Quantity				5,000	200	5,000				
Open	14 to 10 K *	2.1 to 5.3	Low	-	261G3-LPBK	261G3	0.20	5.08	-	-
Open	14 to 10 SF *	2.1 to 6.0	Low	-	200G3L-LPBK	200G3L	0.24	6.10	-	-
Open	20 to 16	0.52 to 1.3	Low	-	262G2-LPBK	262G2	0.16	4.06	-	-
Closed	16 to 12	1.3 to 3.3	Low	1331-BK	1331	0.15	3.81	0.10	2.54	
Closed	20 to 16	0.52 to 1.3	Low	1332-BK	1332	0.12	3.05	0.07	1.78	

K\* - For #10 AWG class K stranded wire or smaller. For larger wires use superflex contacts.  
SF\*- Indicates wires with high stranding such as Super Flex.

Open Barrel Contact

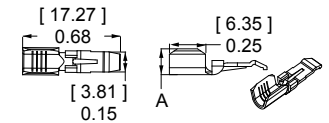

Closed Barrel Contact

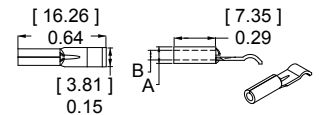

## 45A Premate Ground Wire Contacts - for use with ground housing only

Tin or silver plated contacts are rated for ground or power. Hand tools are available for loose piece contacts. Reeled contacts can be used with high volume press and applicator tooling. Tin contacts are rated for up to 1,500 mating cycles. Silver contacts are rated up to 10,000 mating cycles.

Type	AWG	mm <sup>2</sup>	Mating Force	Loose Piece Part Numbers	Reeled Part Numbers
Minimum Quantity				200	2,500
Open, Tin	14 to 10	2.1 to 6.0	Low	1830G1-LPBK	1830G1
Open, Silver	14 to 10	2.1 to 6.0	Low	1830G2-LPBK	1830G2

Open Barrel Premate Contact

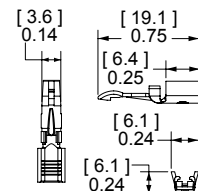

### 25A Right Angle PCB Contacts Tin Plated

Suitable for right angle applications up to 25A per pole. Tin plating enhances solderability. Cannot be mixed with 45A PCB contacts. For mating with wire contacts only.

Row	Mating Force	Loose Piece Part Numbers		Dimensions			
				- A -		- B -	
				inches	mm	inches	mm
Minimum Quantity		1,000	100				
Top	Low	1377G1-BK	1377G1	0.58	14.80	1.52	38.60
	High	1317G1-BK	1317G1				
Bottom	Low	1377G2-BK	1377G2	0.29	7.20	1.36	34.50
	High	1317G2-BK	1317G2				
Top	Low	1377G11-BK	1377G11	0.58	14.80	1.21	30.70
	High	1317G11-BK	1317G11				
Bottom	Low	1377G12-BK	1377G12	0.29	7.20	1.01	25.70
	High	1317G12-BK	1317G12				

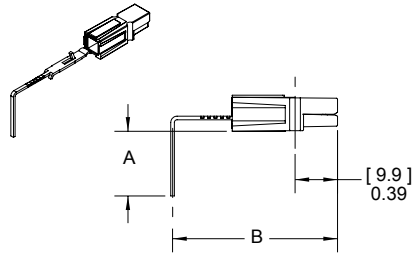

- Use mounting staples with right angle contacts (see accessories).
- See website for PCB layout drawing.

### 25A Vertical PCB Contacts Tin Plated

For mating with wire contacts only. Suitable for vertical applications up to 25A per pole, tin plating enhances solderability.

Mating Force	Loose Piece Part Numbers		Dimensions		
			- A -	inches mm	
Minimum Quantity		1,000	100		
Low		1377G3-BK	1377G3	2.22	56.40
	High	1317G3-BK	1317G3	2.22	56.40
Low		1377G4-BK	1377G4	1.76	44.70
	High	1317G4-BK	1317G4	1.76	44.70
Low		1377G13-BK	1377G13	1.17	29.70
	High	1317G13-BK	1317G13	1.17	29.70

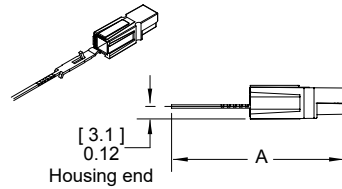

### 45A Right Angle and Vertical PCB Contacts Tin Plated

Suitable for right angle or vertical applications up to 45A per pole. Tin plating enhances solderability. Right angle contacts cannot be mixed with 25A PCB contacts. For mating with wire contacts only.

Description	Loose Piece Part Numbers	
	Minimum Quantity	1,000
Vertical	3-5911P1	1335G1
Right Angle Bottom Row	3-5912P1	1336G1
Right Angle Top Row	3-5913P1	1337G1

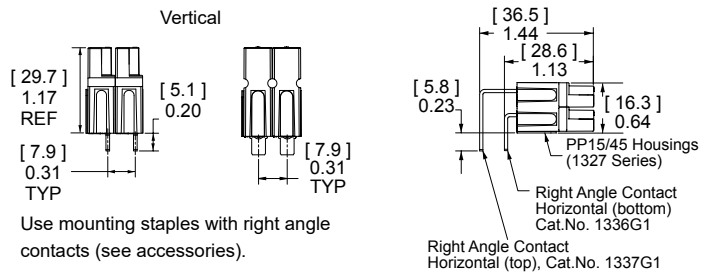

Use mounting staples with right angle contacts (see accessories).

### 45A Premate Ground PCB Contacts

Right angle contacts are suitable for power or ground. Use to mate with 45A ground wire contacts. Tin plated contacts are rated up to 1,500 mating cycles. Can be used with other 45A PCB connectors in the bottom row.

Description	Mating Force	Loose Piece Part Numbers	
		Minimum Quantity	1000
PCB, Bottom Row	Low	3-5952P1	1836G1

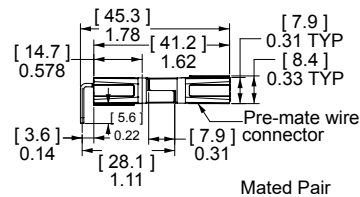

# PP15/45 ULTRASONICALLY BONDED ASSEMBLIES

Assemblies feature housings that are ultrasonically welded to create a one piece connector unit using an Anderson™ special process. After welding, retaining pins are no longer required to secure the stacked housings to each other. This allows Powerpole® 15/45 connectors to be used as a durable one piece connector header. Contact customer service for configurations not shown below.

## Single Row 1x2 Assemblies

Circuit Description	Housings Only	Housings with 45A Vertical PCB Contacts	Housings with 45A Right Angle PCB Contacts	Color & Type Position Matrix	
Minimum Quantity	500	500	500	1	2
DC 2 Wire Standard Housings	ASMPP30-1X2-RK	ASMPV45-1X2-RK	ASMPR45-1X2-RK	RED / STD	BLK / STD
DC 2 Wire Reverse Standard Housings	ASMPP30-1X2-KR	ASMPV45-1X2-KR	ASMPR45-1X2-KR	BLK / STD	RED / STD
DC 2 Wire Finger Proof	ASMFP30-1X2-RK	ASMPV45-1X2-RK	ASMPR45-1X2-RK	RED / FP	BLK / FP
DC 2 Wire Finger Proof Reverse	ASMFP30-1X2-KR	ASMPV45-1X2-KR	ASMPR45-1X2-KR	BLK / FP	RED / FP

## Single Row 1x3 Assemblies

Circuit Description	Housings Only	Housings with 45A Right Angle PCB Contacts	Color & Type Position Matrix		
Minimum Quantity	500	500	1	2	3
DC 2 Wire Finger Proof with Ground	ASMFP30-1X3-KER	ASMPR45-1X3-KER	BLK / FP	GRN / GND	RED / FP
AC Single Phase Finger Proof	ASMFP30-1X3-KEW	ASMPR45-1X3-KEW	BLK / FP	GRN / GND	WHT / FP

## Two Row 2x1 Assemblies

Circuit Description	Housings Only	Housings with 45A Vertical PCB Contacts	Housings with 45A Right Angle PCB Contacts	Color & Type Position Matrix	
Minimum Quantity	500	500	500	1	2
DC 2 Wire Finger Proof	ASMFP30-2X1-KR	ASMPV45-2X1-KR	ASMPR45-2X1-KR	BLK / FP	RED / FP
DC 2 Wire Finger Proof Mate	ASMFP30-2X1-RK	ASMPV45-2X1-RK	ASMPR45-2X1-RK	RED / FP	BLK / FP

## Two Row 2x2 Assemblies

Circuit Description	Housings Only	Housings with 45A Vertical PCB Contacts	Housings with 45A Right Angle PCB Contacts	Color & Type Position Matrix			
Minimum Quantity	500	500	500	1	2	3	4
AC 3 Phase, 3 Wire Finger Proof	ASMFP30-2X2-KRWE	N/A	N/A	BLK / FP	RED / FP	WHT / FP	GRN / GND
AC 3 Phase, 3 Wire Finger Proof Mate	ASMFP30-2X2-WEKR	N/A	ASMPR45-2X2-WEKR	WHT / FP	GRN / GND	BLK / FP	RED / FP

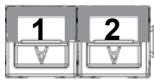

Single Row 1x2 Assembly



Single Row 1x3 Assembly

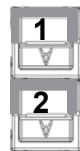

Two Row 2x1 Assembly

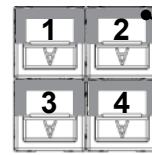

Two Row 2x2 Assembly

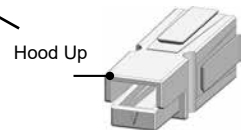

### Type

STD = Standard Housing

FP = Finger Proof Housing

GND = Ground Housing

# Powerpole® Pak Connectors

PP15/45



Powerpole® Pak connector shells enclose stacked groupings of PP15/45 sized housings in a durable black shell for a finished connector appearance and additional features. Inline, panel mount, and blindmate configurations are available. Plug shells offer the option of integral latches and strain relief to help secure your connection.

- **Package Groupings of PP15/45 Connectors**  
*Provides a finished appearance while protecting the individual connectors with an outer shell*
- **Inline, Panel Mount, “T” or Blindmate Configurations**  
*Allows one connection system to meet multiple needs*
- **Optional Latching and Strain Relief**  
*Secures your connection and wires*

## POWERPOLE® PAK ORDERING INFORMATION - Powerpole® housings and contacts are sold separately

### Plug Shell Without Latch

Can mate inline with other plug shells with or without latches, or mate to a panel mount receptacle. For use with all Powerpole® 15/45 connectors only. Cable Clamp and Hardware Pak or Retaining Pins must be ordered separately.

Description	Part Numbers			Dimensions - A -	
				inches	mm
Minimum Quantity	1,000	500	25		
Black, 2 to 4 Poles	1461G1-BK	-	1461G1	1.24	31.50
Black, 5 to 6 Poles	-	1461G2-BK	1461G2	1.56	39.62
Black, 7 to 8 Poles	-	1461G3-BK	1461G3	1.87	47.50

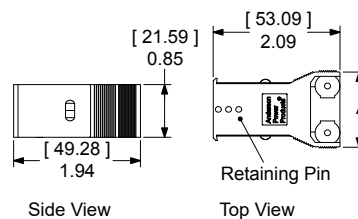

NOTE: Retaining pins are used to secure and position Powerpole® housings in one of three positions in plug shells.

Max wire O.D. for 2 to 4 pole plug shells is 0.60 inches (15.2 mm<sup>2</sup>).  
For all other plug shells is 0.63 inches (16.0 mm<sup>2</sup>).

### Plug Shell With Latch

Can mate inline with other plug shells without latches, or mate to a panel mount receptacle. For use with Powerpole® wire connectors only. Cable Clamp and Hardware Pak or Retaining Pins must be ordered separately.

Description	Part Numbers			Dimensions						
				- B -		- C -		- D -		
			inches	mm	inches	mm	inches	mm	inches	mm
Minimum Quantity	1,000	500	25							
Black, 2 to 4 Poles	1460G1-BK	-	1460G1	1.94	49.28	2.25	57.15	1.24	31.50	
Black, 5 to 6 Poles	-	1460G2-BK	1460G2	1.94	49.28	2.25	57.15	1.56	39.62	
Black, 7 to 8 Poles	-	1460G3-BK	1460G3	1.94	49.28	2.25	57.15	1.87	47.50	
Black, 9 to 10 Poles	-	1460G4-BK	1460G4	2.51	63.75	2.82	71.63	1.84	46.74	

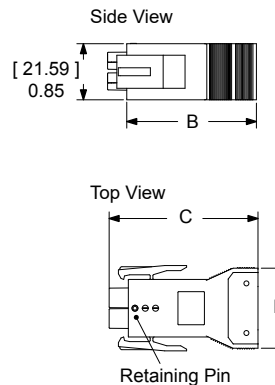

### Plug Shell With Latch & Non-Conductive Strain Relief

New 2X3 Powerpole® Pak offers an improved ergonomic shell for easier latch operation as well as a plastic, non-conductive strain relief. The new strain relief can accommodate up to a 6 conductor 10 AWG cable. Can mate to a panel mount receptacle. For use with Powerpole® wire connectors only. Cable Clamp and Hardware Pak or Retaining Pins must be ordered separately. To be used with 115G23 cable clamp only.

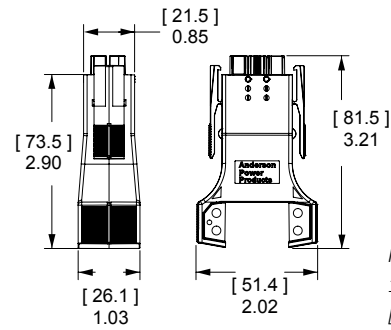

NOTE: Max wire O.D. for 1460G23 is 0.80 inches [20.3 mm<sup>2</sup>].

Description	Part Numbers	
Minimum Quantity	1,000	25
Black, 5 to 6 Poles	1460G23-BK	1460G23

### Snap-in Receptacle Shell

Mate to plug shells with or without latches, or mate to another panel mount receptacle to create a bulkhead to bulkhead connection. For use with Powerpole® wire or PCB connectors. Order the number of retaining pins for each receptacle as shown below separately.

Description	Part Numbers			Number of Retaining to Order	Dimensions - E -		Knock Out Size - Width -	
					inches	mm	inches	mm
Minimum Quantity	1,000	500	25					
Black, 2 to 4 Poles	1470G1-BK	-	1470G1	1	1.50	38.10	1.25	31.75
Black, 5 to 6 Poles	-	1470G2-BK	1470G2	2	1.88	47.75	1.62	41.15
Black, 7 to 8 Poles	-	1470G3-BK	1470G3	3	2.13	54.10	1.88	47.75
Black, 9 to 10 Poles	-	1470G4-BK	1470G4	4	2.44	61.98	2.19	55.63

\* Height = (25.4 mm) 1.0 in.

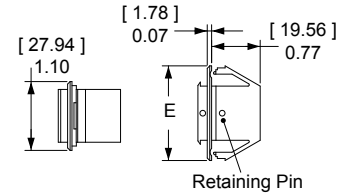

NOTE: Retaining pins are used to secure and position Powerpole® housings in one of two positions in receptacle shells.

### Cable Clamp & Hardware Pak

Includes cable clamp, 2 screws, and required amount of retaining pins for each configuration.

Description	Screw Head Type	Cable Type	Part Numbers		
Minimum Quantity			1,000	500	25
2 to 4 Poles	Straight Slot	Bundled	115G1-BK	-	115G1
5 to 6 Poles	Straight Slot	Bundled	115G2-BK	-	115G2
7 to 8 Poles	Straight Slot	Bundled	115G3-BK	-	115G3
9 to 10 Poles	Straight Slot	Bundled	-	115G4-BK	115G4
2 to 4 Poles	Phillips	Bundled	115G7-BK	-	115G7
5 to 6 Poles	Phillips	Bundled	115G8-BK	-	115G8

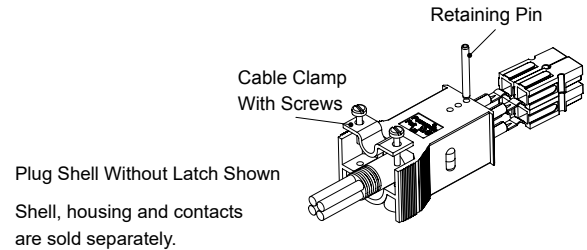

Plug Shell Without Latch Shown  
Shell, housing and contacts are sold separately.

### Cable Clamp & Hardware Pak

Includes 2 cable clamp halves, 2 screws and 2 retaining pins. To be used with 1460G23 Plug Shell only.

Description	Screw Head Type	Cable Type	Part Numbers	
Minimum Quantity			1,000	25
5 to 6 Poles	Phillips	Bundled	115G23-BK	115G23

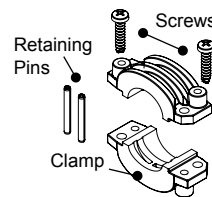

### Flexible Conduit Clamp & Hardware Pak

Includes cable clamp, 2 screws, and need amount of retaining pins for each configuration.

Description	Part Number
Minimum Quantity	100
2 to 4 Poles	110G10

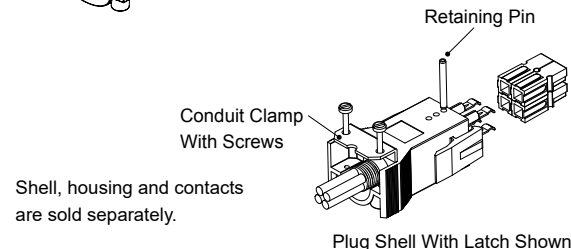

Shell, housing and contacts are sold separately.

Plug Shell With Latch Shown

### Retaining Pin for Snap-in Receptacle

Order the number of retaining pins for each receptacle shown in the Snap-in Receptacle Shell ordering information. Pins are also required for the plug side when the Cable Clamp & Hardware Pak is not ordered.

Description	Part Numbers	
Minimum Quantity	1,000	100
Retaining Pin	110G9-BK	110G9

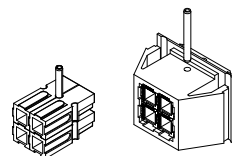

Shell and housing are sold separately.

## Blindmate Pak Connector

Ideal for panel to panel, bulkhead to bulkhead, or rack mount applications that require the power connector to compensate for up to 0.45 in. (11.43 mm) of misalignment in either axis. Eight positions can be filled with Powerpole® 10 to 45 connectors. The receptacle side can be used with wire or PCB contacts. Hardware bag includes retaining pins.

Description	Part Numbers	
Minimum Quantity	50	25
2x4 Blindmate Plug Shell, Hardware & Pins	-	BMPP10-45P
2x4 Blindmate Receptacle Shell, Hardware & Pins	-	BMPP10-45R
2x4 Blindmate Plug Shell	BMHSG-P	-
2x4 Blindmate Receptacle Shell	BMHSG-R	-
Hardware Bag Plug Side	-	110G50
Hardware Bag Receptacle Side	-	110G51

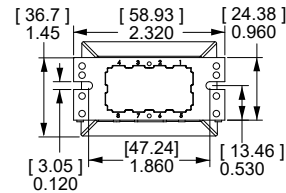
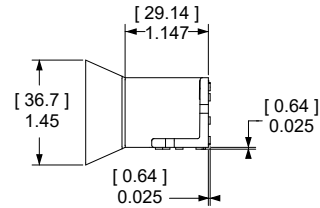
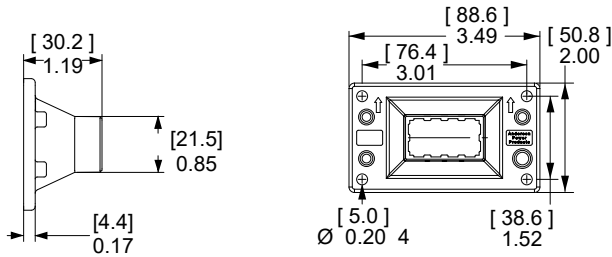

See our innovative MARC Connector that offers straight-on or rotational blindmate capability. MARC holds 6 PP15/45 power contacts and 2 PP15/45 premate ground contacts in a high temperature housing. Visit our website [www.andersonpower.com](http://www.andersonpower.com) to learn more.



## “T” Pak 2 Way Splitter

The Powerpole® “T” Pak connector is a 2 way electrical splitter that splits electrical current from one incoming circuit into two outgoing circuits. The standard configuration is pre-wired for AC 3 phase, 3 wire plus ground configurations. The “T” Pak can also be used for AC single phase plus ground or DC 2 wire plus ground applications by not using either the red or white power positions. “T” Pak is pre-wired from the factory allowing plug and play field installation of modular office and industrial equipment. UL recognition up to 20 amps and 600 volts is achieved when mating Powerpole® Pak plugs with 12 AWG wire.

For OEM manufacturing scale applications, the “T” Pak can be loaded with custom configurations of any of our finger proof, standard, or ground housings and contacts in the PP15/45 series. Contact sales or customer service for additional information.

Description	Part Numbers
Minimum Quantity	80
Assembled “T” Pak	20-01
Mating Plug Shell with Latch 2x2	26-01
Mating Plug Shell without Latch 2x2	27-01

Standard configuration for each side of the T includes (1) each Red, Black, and White Standard PP15/45 Housings & 261G2-LPBK contacts with (1) 45A Green Premate Ground Housing and 1830G1-LPBK contact.

Mating plug shells include (1) each Red, Black, and White Standard PP15/45 Housings & (3) 261G2-LPBK contacts with (1) 45A Green Premate Ground Housing and 1830G1-LPBK contact. Cable clamp & hardware pack also included.

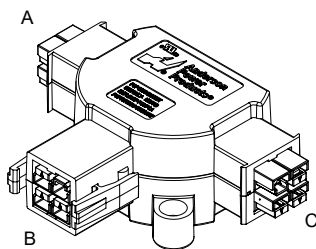
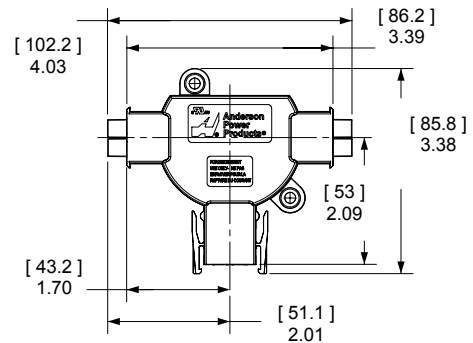

27 - 01  
Mates With B



26 - 01  
Mates With A & C



# PP15/45 CONNECTOR TEMPERATURE CHARTS - Temperature rise charts are based on a 25°C ambient temperature.

Current - Temperature Derating per IEC 60512-5-2 Test 5B

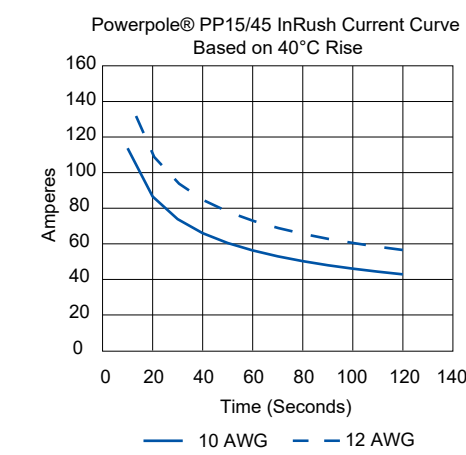
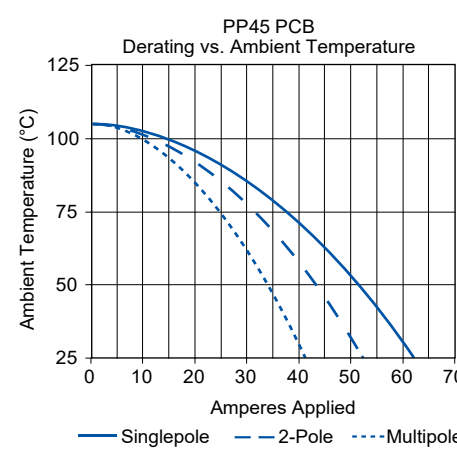
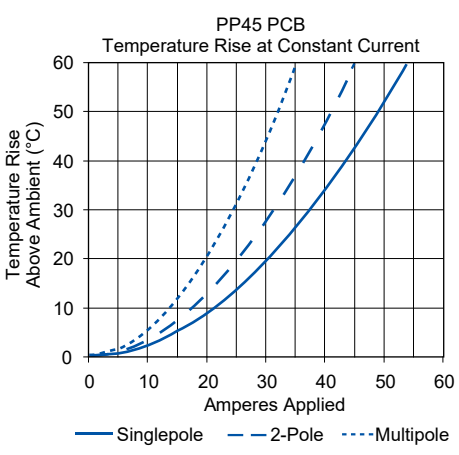
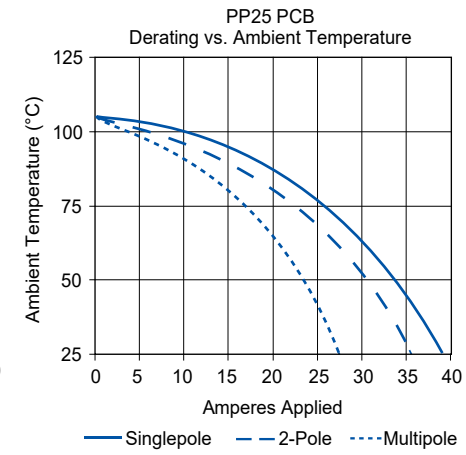
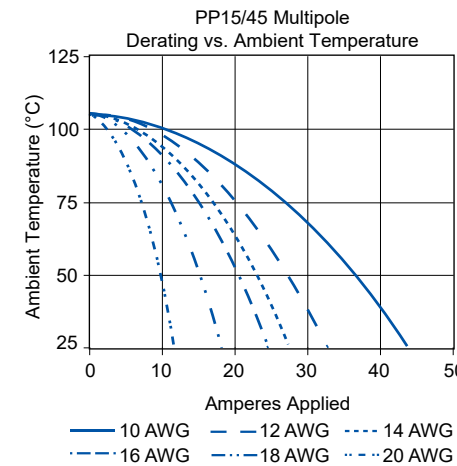
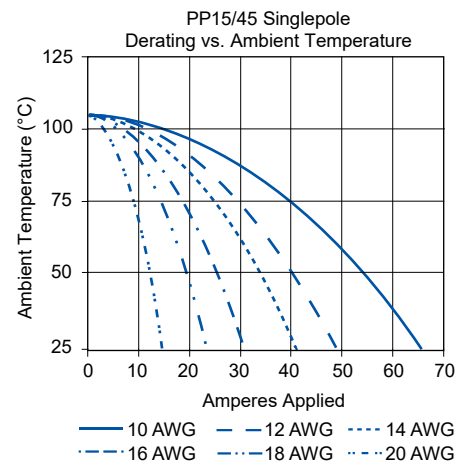
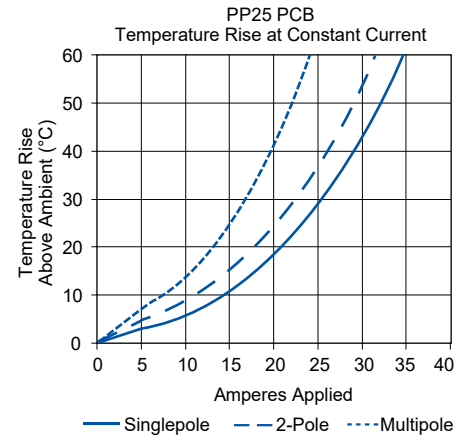
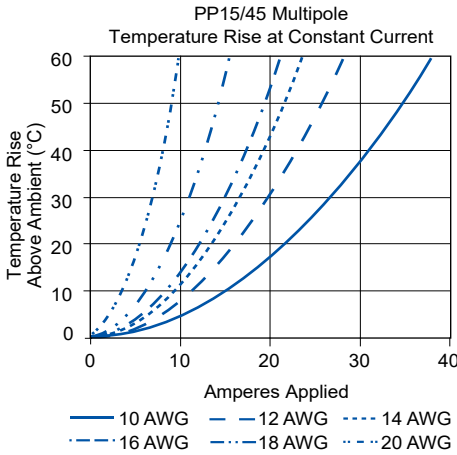
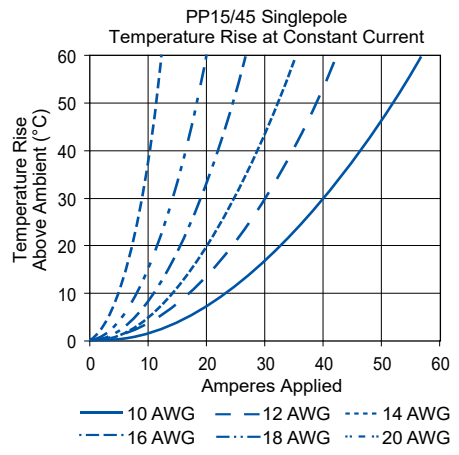

NOTE: PP25 PCB charts based on 0.002 in<sup>2</sup> foil on board side, mated to 12 AWG conductor on wire side. PP45 PCB charts based on 10 AWG equivalent copper foil on board side, mated to 10 AWG conductor on wire side.



# PP15/45 & POWERPOLE® PAK SPECIFICATIONS

## ELECTRICAL

Current Rating Amperes <sup>1</sup>	UL 1977	CSA / TUV
Singlepole Wire-to-Wire (10 AWG)	55	40
Singlepole Ground Wire-to-Wire or PCB (10 AWG)	45	35
3x3 Block Wire-to-Wire (10 AWG)	40	27
Singlepole 25A PCB-to-Wire (12 AWG)	25	-
2x3 Block 25A PCB-to-Wire (12 AWG)	25	22 *
Singlepole 45A PCB-to-Wire (10 AWG)	45	40 *
2x3 Block 45A PCB-to-Wire (10 AWG)	45	25 *

Voltage Rating AC/DC	
UL 1977	600

Dielectric Withstanding Voltage	
Volts AC	2,200

Avg. Mated Contact Resistance Milliohms <sup>1</sup>	
15A Wire Contact with 5/8" of 16 AWG	0.875
30A Wire Contact with 5/8" of 12 AWG	0.600
45A Wire Contact with 5/8" of 10 AWG	0.525
45A PCB Contact to Contact	0.500
25A PCB Contact to Contact	0.600

UL Hot Plug Current Rating Amperes <sup>5</sup>	
250 Cycles at 72V DC	45A
250 Cycles at 120V DC	30A

UL Ground Short Time Current Test - 45A Premate Ground	
750 Amps, 10 AWG Wire	4 Seconds
470 Amps, 12 AWG Wire	4 Seconds

## MATERIAL

### Housing

Plastic Resin	Polycarbonate
Contact Retention Spring	Stainless Steel

### Housing Flammability Rating

UL94	V-0
Glow Wire	825°C (GWFI) / 800°C (GWIT)

### Contact

Base	Copper Alloy
Plating	Tin or Silver

### Contact Termination Methods

Crimp <sup>3</sup>	Wire Contacts
Hand Solder	1331, 1332 & PCB Contacts
Solder Dip	PCB Contacts
Wave Solder	PCB Contacts

## MECHANICAL

Wire Size Range	AWG	mm <sup>2</sup>
	20 to 10	0.75 to 6.0

Max. Wire Insulation Diameter	in.	mm
	0.175	4.450

Operating Temperature <sup>2</sup>	°F	°C
Powerpole® Housings & Powerpole® Pak Shells	-4° to 221°	-20° to 105°

Mating Cycles No Load by Plating	Silver (Ag)	Tin (Sn)
PCB-to-Wire	-	1,500
Wire-to-Wire	10,000	1,500

Avg. Mating / Unmating Force	Lbf.	N
Low Force Wire, High Force PCB, & Ground	3	13
High Force Wire	5	22
Low Force PCB	2	9

Min. Contact / Spring Retention Force	Lbf.	N
	20	90

Powerpole® Pak Latch Avg. Defeat Force	Lbf.	N
	150	667

PCB Specifications		
Mounting Style	Plated Through Hole	
PCB Thickness - in. (mm)	0.090 to 0.150	2.3 to 3.8
25A PCB Recommended Traces	12 AWG Cross Section	
45A PCB Recommended Traces	10 AWG Cross Section	

Mechanical Shock <sup>4</sup>		
MIL-STD-202	213 Condition A	50g's

Vibration High Frequency <sup>4</sup>		
MIL-STD-202	204 Condition A	10g's

NOTE 1: See IEC 60664-1 for working voltage.

NOTE 2: Amp ratings are stated per position and based on all positions being fully loaded.

\* No TUV Recognition

1 - Based on: 105°C rated or better cable of the largest size.

Properly calibrated Anderson Power™ recommended tooling, and a 25°C ambient temperature. UL rating not to exceed the maximum operating temperature. CSA rating below a 30°C temperature rise.

2 - Limited by the thermal properties of the connector plastic housing.

3 - Use Anderson Power™ recommended tooling only. Alternate tools may adversely affect the performance of our connectors along with UL and CSA recognition.

4 - Tested with contact part number 261G2.

5 - Based on 2 housings blocked together.



## IEC INFORMATION

Connector Series	Configurations	Creepage / Clearance per IEC 60950-1	Material Group
PP15/45 Standard	Single Pole	Unmated	1.64 mm
		Mated	1.64 mm
	Stacked Powerpole®	Unmated	1.64 mm
		Mated	1.64 mm
	PCB - 25A	Unmated	1.64 mm
		Mated	1.64 mm
	PCB - 45A	Unmated	1.39 mm
		Mated	1.39 mm
			IIIa

Connector Series	Configurations	Creepage / Clearance per IEC 60950-1	Material Group
PP15/45 Finger Proof	Single Pole	Unmated	1.64 mm
		Mated	4.20 mm
	Stacked Powerpole®	Unmated	1.64 mm
		Mated	4.20 mm
	PCB - 25A	Unmated	1.64 mm
		Mated	2.90 mm
	PCB - 45A	Unmated	1.39 mm
		Mated	1.39 mm
			IIIa

ATTRIBUTES	PP45	PP45 FINGER PROOF
AMP Rating AC/DC	45	45
Voltage Rating AC/DC (Steady State)	160 V AC/DC (Operational)	400 V AC/DC (Operational)
Breaking Capacity - AMP Rating / Cycles	30 Amp / 10 Cycles	30 Amp / 10 Cycles
Voltage Rating (Breaking Capacity)	220 VDC	220 VDC
FINGER Safety - Mated Only	IEC 60529 - IP20	IEC 60529 - IP20 *
Wire Size Tested	6 mm <sup>2</sup>	6 mm <sup>2</sup> (10AWG)
Contact Series Tested	200G3L	200G3L
Climatic Testing (Cold, Heat & MFG)	IEC 60512 Test - 11j, 11i & 11g	IEC 60512 Test-11j, 11i & 11g
Cycle Life	IEC 60512 Test 9a - 5,000 Cycles	IEC 60512 Test 9a - 5,000 Cycles
Mechanical Strength Impact	IEC 60512-5 @ 29.5 Inches - Dropped 8 Times	IEC 60512-5 @ 29.5 Inches - Dropped 8 Times
Temperature Range	-20°C to 105°C -4°F to 221°F	-20°C to 105°C -4°F to 221°F

\* Mated and unmated for the PP15/45 FP version only

### PROTECTION

#### Touch Safety with Finger Proof Housings & Wire Contacts or PCB Mating Interface

UL1977 Sec. 10.2	Pass
IEC 60950	Pass
IEC 60529	IP20

#### Touch Safety With Standard Housings

IEC 60529	IP10
-----------	------



# POWERPOLE® 15/45 ACCESSORIES

## Mounting Wing

Secure dovetailed Powerpole® 15/45 series housings by passing fasteners through the wings in either a horizontal or vertical orientation. Useful for sheet metal panels, printed circuit boards, and many other mounting surfaces. Fasteners not included.

Description	Part Numbers	
Minimum Quantity	2,500	100
Red	1399G9-BK	1399G9
Blue	1399G8-BK	1399G8

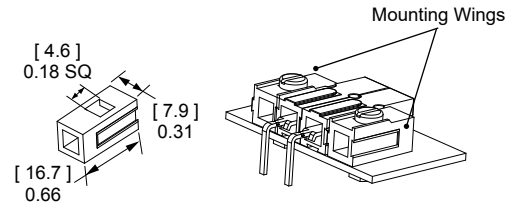

## Spacer

Used to separate housings under high power to minimize derating. They are recommended for squaring off a block of Powerpole® 15/45 housings for use in connector shells and mounting clamps. Use a combination of long and short spacers opposite each other in a mated block to add keying features or use two short spacers to avoid interference. Spacers with holes can also be used to fasten the blocked housings to a surface with a fastener.

Description	Part Numbers	
Minimum Quantity	2,500	100
Red, Short w/ Hole	1399G1-BK	1399G1
Red, Long	1399G2-BK	1399G2
Red, Short	1399G6-BK	1399G6
Black, Long	1399G10-BK	1399G10
Blue, Short	1399G13-BK	1399G13
White, Short w/ Hole	1399G14-BK	1399G14
White, Long	1399G17-BK	1399G17

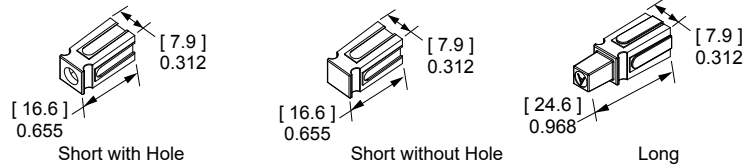

## Retaining Pins

Keep stacked Powerpole® 15/45 series housings from separating. Retaining pins are inserted in the circular opening between two housings stacked side by side.

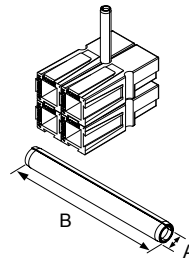

Description	Part Numbers		Dimensions			
			- A -		- B -	
			inches	mm	inches	mm
Minimum Quantity	1,000	100				
1 Block High	H1507P38	110G16	0.093 / 0.103	2.360 / 2.62	0.250	6.350
2 Block High	111812P5	110G17	0.093 / 0.103	2.360 / 2.62	0.440	11.180

## Mounting Clamp

Mounting clamps can be used for fastening a block of Powerpole® 15/45 series housings to a panel. Connector blocks must be a complete square for the clamps to work properly. Fastening hardware not included.

Description	Part Numbers	
Minimum Quantity	100 sets of 2	
2 or 4 Pole	1462G1	
3 or 6 Pole	1462G2	
4 or 8 Pole	1462G3	

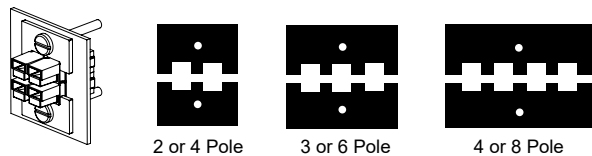

## PCB Mounting Staples

PCB staples are soldered into place to secure Powerpole® 15/45 series housings in a horizontal configuration to the board. Reduce strain on soldering joints during mating and unmating.

Part Numbers	H x W	Length	Dimensions			
			- A -		- B -	
			inches	mm	inches	mm
Minimum Quantity 100						
114555P1	1 x 1	Short	0.47	12.0	0.28	7.0
114555P2	1 x 2	Short	0.47	12.0	0.57	14.5
114555P3	1 x 3	Short	0.47	12.0	0.89	22.5
114555P7	1 x 4	Short	0.47	12.0	1.20	30.5
114555P10	2 x 1	Short	0.79	20.0	0.28	7.0
114555P6	2 x 2	Short	0.79	20.0	0.57	14.5
114555P9	2 x 2	Long	0.91	23.0	0.57	14.5

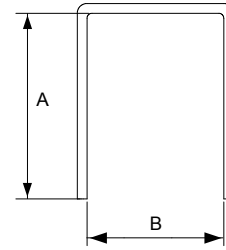

## Retention Clip

Retention clips prevent Powerpole® 15/45 blocks from unintended disconnects. They feature a tab for easy insertion and removal.

Description	Part Number
Minimum Quantity	100
1 Block High	110G68

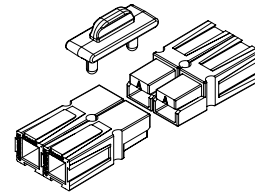

## Block Lok

Block locks secure mated Powerpole® 15/45 series housings together. For use in high vibration or shock applications where connectors are unmated infrequently.

Description	Part Numbers
Minimum Quantity	100
2 Pole, Black	110G21
4 Pole, Black	110G12

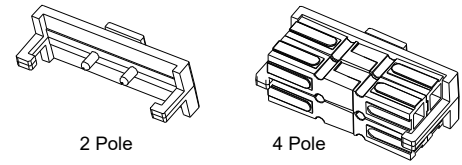

2 Pole  
Shown without Powerpoles

4 Pole  
Shown with Powerpoles

## Splash Boot

Splash boots protect a 2x2 block of any combination of Powerpole® 15/45 series housings and feature snip off sealed ends for flexibility in wire O.D. Designed for through panel or inline applications. Not a hermetic seal.

Description	Part Numbers
Minimum Quantity	25
Female, Black	1441G1
Male, Black	1442G1

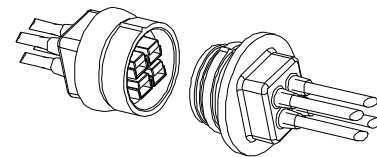

## Dust Cover for Powerpole® Pak

Protect your Powerpole® Pak connector from most foreign material and potentially prevent premature degradation of the product. Contact customer service for the other possible configurations.

Description	Part Numbers	Dimensions	
		- A -	
Minimum Quantity	2,500	500	
2x2, Orange	2-8831P1-BK	2-8831P1	1.32 (33.5)
2x3, Orange	2-8831P2-BK	2-8831P2	1.42 (36.0)

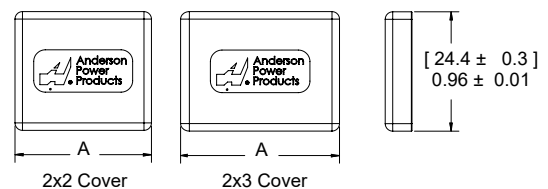

2x2 Cover

2x3 Cover

[ 24.4 ± 0.3 ]  
0.96 ± 0.01

# Powerpole®

Tooling Information - Anderson Power™ Applicators are Mechanical Feed Style and do not Require an Air Feed Kit.

Wire Size		Loose Piece Part Number		Loose Piece Contact Crimp Tools								
AWG	mm <sup>2</sup>	Tin Plating	Silver Plating	Hand Tool	OR	Pneumatic Bench Tool	+	Die	+	Locator	Number of Crimps	Insertion Extraction Tool
<b>PP15 / 45 Flat Wiping Power &amp; Ground</b>												
16 to 20	1.3 to 0.52	N/A	1332	1309G2 or 1309G8								
12 to 16	3.3 to 1.3	N/A	1331									
16 to 20	1.3 to 0.52	262G1-LPBK	262G2-LPBK									
16 to 20	1.3 to 0.52	269G2-LPBK	N/A	1309G3 or 1309G8	N/A			N/A		N/A	Single	111038G2
12 to 16	3.3 to 1.3	261G1-LPBK	N/A									
10 to 14	5.3 to 2.1	261G2-LPBK	261G3-LPBK									
12 to 16	3.3 to 1.3	269G1-LPBK	N/A	1309G6 or 1309G8								
10 to 14	5.3 to 2.1	269G3-LPBK	N/A									
10 to 14	5.3 to 2.1	200G1L-LPBK	200G3L-LPBK									
10 to 14	5.3 to 2.1	201G1H-LPBK	N/A									
10 to 14	5.3 to 2.1	1830G1-LPBK	1830G2-LPBK									

NOTE: see website for the most current information.

Wire Size		Reeled Part Number		Reeled Contact Crimp Tools		
AWG	mm <sup>2</sup>	Tin Plating	Silver Plating	Anderson Power™ Applicator	+	Anderson Power™ Press
<b>PP15/45 Flat Wiping Power &amp; Ground</b>						
16 to 20	1.3 to 0.52	262G1	262G2	TD0101		115V = TE0101 230V = TE0102
16 to 20	1.3 to 0.52	269G2	N/A			
12 to 16	3.3 to 1.3	261G1	N/A			
10 to 14	5.3 to 2.1	261G2	261G3			
12 to 16	3.3 to 1.3	269G1	N/A			
10 to 14	5.3 to 2.1	269G3	N/A	TD0102		
10 to 14	5.3 to 2.1	200G1L	200G3L			
10 to 14	5.3 to 2.1	201G1H	N/A			
10 to 14	5.3 to 2.1	1830G1	1830G2			

NOTE: Loose piece PP15/45 should only be crimped using hand tools. Reeled PP15/45 contacts are to be crimped using appropriate press applicator and die.

All Data Subject to Change Without Notice 2024-0103 DS-PP1545 REV 8 Your Best Connection™

Anderson™ will use reasonable efforts to include accurate and up-to-date content in the data sheet. All product information contained in the data sheet including ordering information, illustrations, specifications, and dimensions, are believed to be reliable as of the date of publishing, but is subject to change without notice. Anderson™ makes no warranty or representation as to its accuracy. Content in the data sheet may contain technical inaccuracies, typographical errors and may be changed or updated without notice. Anderson™ may also make improvements and/or changes to the products and/or to the programs described in the content at any time without notice. Current sales drawings and specifications are available upon request.

©2024 Anderson Power Products, Inc. All rights reserved. Anderson Power Products®, and Powerpole® are registered trademarks of Anderson Power Products, Inc. Anderson™, Anderson Power™, Anderson Power™ logo and Your Best Connection™ are trademarks of Anderson Power Products, Inc.



**HEADQUARTERS:** Anderson Power Products®, 13 Pratts Junction Road, Sterling, MA 01564-2305 USA T: +1 978-422-3800 F: +1 978-422-0128 • **EUROPE:** Anderson Power Products® Ltd., Unit 3, Europa Court, Europa Boulevard, Westbrook, Warrington, Cheshire, WA5 7TN United Kingdom T: +44 (0) 1925 428390 F: +44 (0) 1925 520203 • **GERMANY:** IDEAL® Industries Germany GmbH, Esslinger Strasse 7, D – 70771 Leinfelden-Echterdingen, T: +49 (0) 711 – 997606666 • **ASIA / PACIFIC:** IDEAL® Anderson Asia Pacific Ltd., Unit 922-928 Topsail Plaza, 11 On Sum Street, Shatin N.T., Hong Kong T: +(852) 2636 0836 F: +(852) 2635 9036 • **INDIA:** IDEAL® INDUSTRIES India Private Limited, 229-230, SPAZEDGE, Tower B, Sector 47, Sohna Road, Gurgaon – 122018, Haryana, India T: +(91) 956-0075905 T: +(91) 124-4495101 • **CHINA:** IDEAL® Anderson Technologies (Shenzhen) Ltd., Block A8 Tantou Western Industrial Park, Songgang Baoan District, Shenzhen, PR. China 518105 T: +(86) 755 2768 2118 F: +(86) 755 2768 2218 • [www.ideal-industries.in](http://www.ideal-industries.in) • [www.andersonpower.com](http://www.andersonpower.com)