



LTCC SMT

High Pass Filter

HFCG-2500+

50Ω 2.7 to 14.5 GHz

THE BIG DEAL

- Low Insertion Loss, 0.9 dB Typ.
- Return Loss, 11 dB Typ.
- Stop Band Rejection, 48 dB Typ.
- 0805 Surface Mount Footprint
- Power Handling: 4 Watts



Generic photo used for illustration purposes only

CASE STYLE: GE0805C-9

+RoHS Compliant

The +Suffix identifies RoHS Compliance. See our website for methodologies and qualifications

APPLICATIONS

- Test and Measurement Equipment
- Communications, Radar, EW, and ECM Defense Systems
- 5G MIMO and Back Haul Radio Systems
- 5G Sub 6 GHz
- WiFi 6E

PRODUCT OVERVIEW

HFCG-2500+ is a miniature low temperature co-fired ceramic (LTCC) high pass filter with a 2.7 to 14.5 GHz passband supporting a variety of applications. This model provides 0.9 dB typical insertion loss over a wide band due to its rugged monolithic construction. Housed in a tiny 0805 ceramic form factor with inspectable wrap-around terminations, the filter is ideal for dense signal chain PCB layouts where it complements MMIC size and performance. The LTCC fabrication process assures minimal RF performance variation while delivering a product that is well suited for environmental extremes of high humidity and temperature.

KEY FEATURES

Feature	Advantages
Small size, 0805	Accommodates tight space requirements for dense PCB layouts.
Wrap around termination	Provides excellent solderability and easy visual inspection capability.
LTCC construction	Provides a rugged package that is well suited for tough environments including high humidity and high temperature extremes.
Ultra-wide pass band	This filter has a very wide passband from 2.7 to 14.5 GHz.
Rugged Power handling	Handles up to 4 Watts in a small 0805 package.

REV. B
ECO-016177
HFCG-2500+
EDU4458
URJ
221220





LTCC SMT

High Pass Filter

HFCG-2500+

ELECTRICAL SPECIFICATIONS^{1,2} AT 25°C

Parameter		F#	Frequency (GHz)	Min.	Typ.	Max.	Units
Stopband	Rejection	DC-F1	DC - 1.55	42	48	—	dB
		F1-F2	1.55 - 1.95	20	30	—	
	Freq. Cut-Off	F3 ^(note 3)	2.5	—	3	—	
Passband	Insertion Loss	F4-F5	2.7 - 3.5	—	2.0	—	dB
		F5-F6	3.5 - 13.5	—	0.9	1.5	
		F6-F7	13.5 - 14.5	—	1.2	—	
	Return Loss	F4-F5	2.7 - 3.5	—	13	—	dB
		F5-F6	3.5 - 13.5	—	11	—	
		F6-F7	13.5 - 14.5	—	14	—	

1. This component should not be employed as a DC-block. DC blocking capacitors are required in applications where DC voltage and/or current is present at either input or output ports. Please contact Mini-Circuits for further support.

2. Measured on Mini-Circuits Characterization Test Board TB-HFCG-2500+

3. Typically, a ±5% frequency deviation from the stated value may occur on a unit-to-unit basis.

ABSOLUTE MAXIMUM RATINGS¹

Parameter	Ratings
Operating temperature	-55°C to 125°C
Storage temperature	-55°C to 125°C
RF Power Input ²	4W @25°C

1. Permanent damage may occur if any of these limits are exceeded.

2. Power rating applies only to signals within the passband. Power rating above +25°C should be derated linearly to 0.9W at +125°C.

TYPICAL FREQUENCY RESPONSE

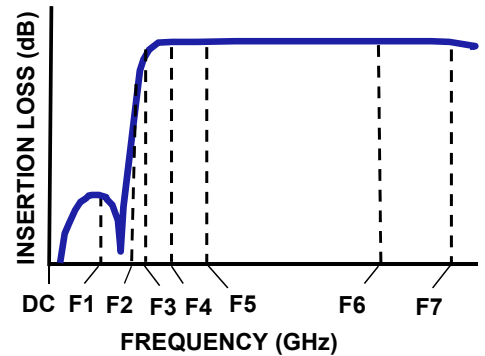

FUNCTIONAL DIAGRAM

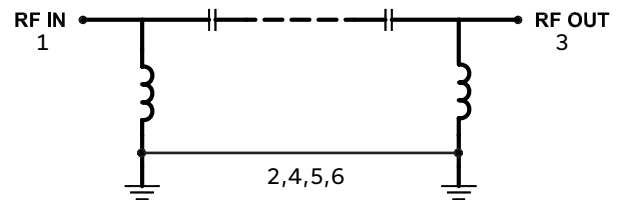



LTCC SMT

High Pass Filter

HFCG-2500+

PAD CONNECTIONS

RF IN	1
RF OUT	3
GROUND	2,4,5,6

PRODUCT MARKING: VU

DEMO BOARD MCL P/N: TB-HFCG-2500+
SUGGESTED PCB LAYOUT (PL-633)

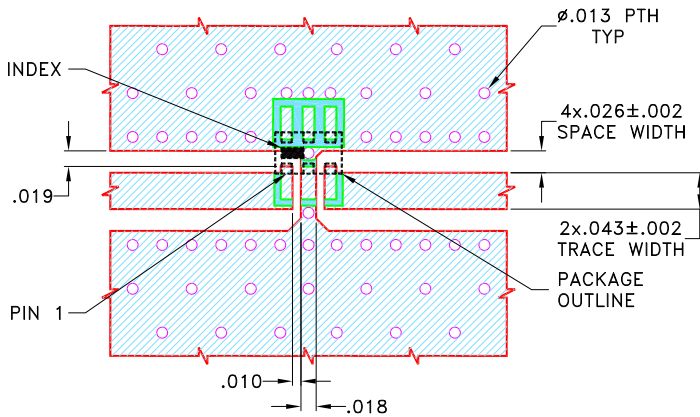

NOTES:

1. COPLANAR WAVEGUIDE PARAMETERS ARE SHOWN FOR ROGERS (R04350B) WITH DIELECTRIC THICKNESS $.020 \pm .0015$. COPPER: 1/2 Oz. EACH SIDE. FOR OTHER MATERIALS TRACE WIDTH AND GAP MAY NEED TO BE MODIFIED.
 2. BOTTOM SIDE OF THE PCB IS CONTINUOUS GROUND PLANE.
- DENOTES PCB COPPER PATTERN WITH SMOBC (SOLDER MASK OVER BARE COPPER)
 DENOTES PCB COPPER PATTERN FREE OF SOLDERMASK

OUTLINE DRAWING

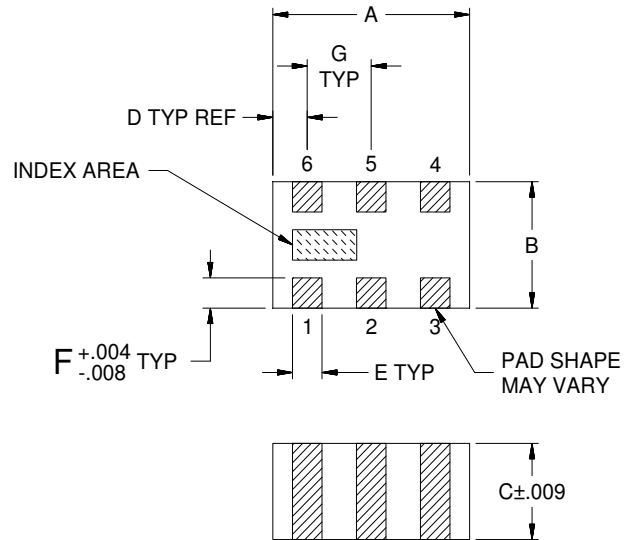

OUTLINE DIMENSIONS (Inches/mm)

A	B	C	D	E	F	G	Wt.
.079	.049	.037	.014	.012	.012	.026	grams
2.00	1.25	0.95	0.35	0.30	0.30	0.65	.008



LTCC SMT

High Pass Filter

HFCG-2500+

TYPICAL PERFORMANCE DATA AT 25°C

Frequency (MHz)	Insertion Loss (dB)	Return Loss (dB)
10	76.08	0.04
100	65.86	0.03
1000	48.66	0.12
1550	54.66	0.26
1950	31.74	0.41
2000	28.55	0.47
2100	22.40	0.67
2300	10.51	2.06
2500	2.65	11.94
2700	1.40	16.04
3500	0.55	30.24
5000	0.31	20.98
10000	0.31	16.50
13500	0.57	22.61
14500	0.79	19.66

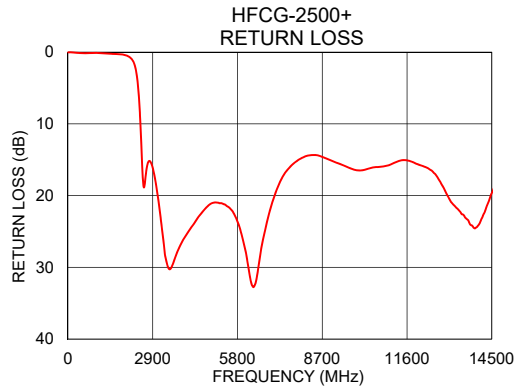
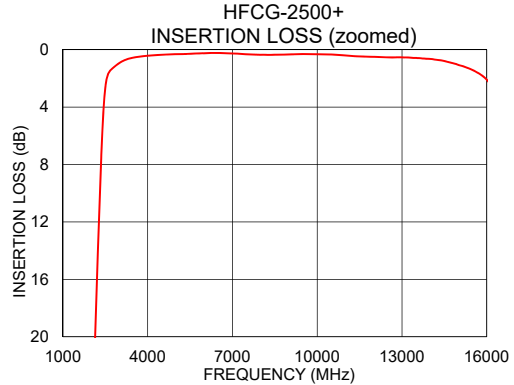
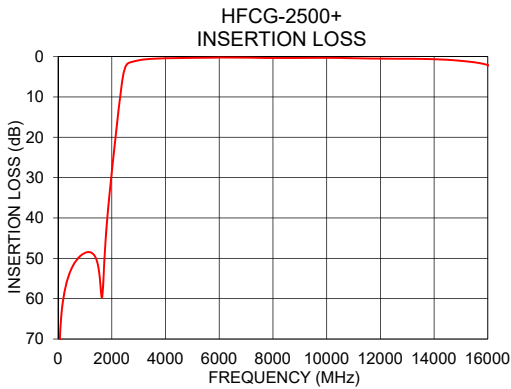

NOTES

- A. Performance and quality attributes and conditions not expressly stated in this specification document are intended to be excluded and do not form a part of this specification document.
- B. Electrical specifications and performance data contained in this specification document are based on Mini-Circuit's applicable established test performance criteria and measurement instructions.
- C. The parts covered by this specification document are subject to Mini-Circuits standard limited warranty and terms and conditions (collectively, "Standard Terms"); Purchasers of this part are entitled to the rights and benefits contained therein. For a full statement of the standard. Terms and the exclusive rights and remedies thereunder, please visit Mini-Circuits' website at www.minicircuits.com/MCLStore/terms.jsp

