

Coaxial Frequency Mixer

ZFM-11+

Level 7 (LO Power +7 dBm) 1 to 2000 MHz



Generic photo used for illustration purposes only

CASE STYLE: K18

Connectors	Model
BNC	ZFM-11+
SMA	ZFM-11-S+
BRACKET (OPTION "B")	

+RoHS Compliant

The +Suffix identifies RoHS Compliance. See our web site for RoHS Compliance methodologies and qualifications

Maximum Ratings

Operating Temperature	-55°C to 100°C
Storage Temperature	-55°C to 100°C
RF Power	50mW
IF Current	40mA

Permanent damage may occur if any of these limits are exceeded.

Coaxial Connections

LO	1
RF	2
IF	3

Features

- low conversion loss, 7.03 dB typ.
- good L-R isolation, 35 dB typ, L-I, 27 dB typ.
- wideband, 1 to 2000 MHz
- rugged shielded case

Applications

- VHF/UHF
- cellular
- GPS
- satellite distribution
- instrumentation

Outline Drawing

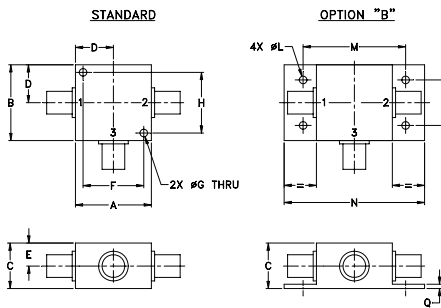

Outline Dimensions (inch/mm)

A	B	C	D	E	F	G	H
1.25	1.25	.75	.63	.38	1.00	.125	1.000
31.75	31.75	19.05	16.00	9.65	25.40	3.18	25.40

J	K	L	M	N	P	Q	wt
--	--	.125	1.688	2.18	.75	.07	grams
--	--	3.18	42.88	55.37	19.05	1.78	70.0

Electrical Specifications

FREQUENCY (MHz)		CONVERSION LOSS (dB)				LO-RF ISOLATION (dB)			LO-IF ISOLATION (dB)							
LO/RF	IF	Mid-Band m		Total Range	L	M	U	L	M	U						
f_L-f_U		\bar{X}	σ	Max.	Typ.	Min.	Typ.	Min.	Typ.	Min.						
1-2000	5-600	7.03	.017	8.5	9.0	50	45	35	25	20	45	40	27	20	25	20

1 dB COMP.: +1 dBm typ.

L = low range [f_L to $10 f_L$] M = mid range [$10 f_L$ to $f_U/2$] U = upper range [$f_U/2$ to f_U]
m = mid band [$2f_L$ to $f_U/2$]

Typical Performance Data

Frequency (MHz)		Conversion Loss (dB)	Isolation L-R (dB)	Isolation L-I (dB)	VSWR RF Port (:1)	VSWR LO Port (:1)
RF	LO	LO +7dBm	LO +7dBm	LO +7dBm	LO +7dBm	LO +7dBm
1.00	31.00	6.05	60.95	56.30	2.34	2.51
5.00	35.00	5.78	61.86	55.70	2.49	2.42
20.00	50.00	5.81	61.93	55.12	2.44	2.46
50.00	80.00	5.94	60.22	54.24	2.54	2.19
100.00	70.00	5.92	56.59	50.92	2.88	2.23
200.00	170.00	6.50	48.94	44.33	3.21	2.18
267.53	237.53	6.52	45.81	41.60	3.60	1.98
400.80	370.80	6.74	42.38	38.67	3.74	1.88
500.00	470.00	6.83	41.61	36.88	3.84	1.82
600.70	570.70	7.03	40.10	36.28	3.52	1.69
733.96	704.29	7.24	39.39	34.20	3.24	1.51
867.23	837.52	7.09	39.07	31.66	3.00	1.37
1000.00	969.69	7.12	36.76	29.17	2.77	1.24
1067.10	1037.50	6.97	35.43	28.56	2.54	1.14
1200.40	1170.40	6.77	33.71	27.07	2.23	1.13
1333.70	1303.60	6.72	32.82	25.51	2.13	1.39
1466.90	1436.90	6.80	33.13	24.22	2.16	1.67
1600.20	1570.50	6.93	32.34	23.42	2.27	2.36
1733.50	1703.70	6.92	29.41	27.19	2.54	2.01
2000.00	1970.30	6.99	30.47	25.17	2.89	1.93

Electrical Schematic

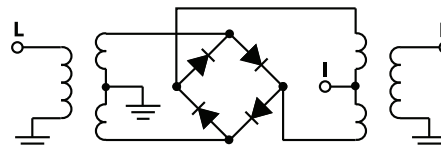

Notes

- Performance and quality attributes and conditions not expressly stated in this specification document are intended to be excluded and do not form a part of this specification document.
- Electrical specifications and performance data contained in this specification document are based on Mini-Circuit's applicable established test performance criteria and measurement instructions.
- The parts covered by this specification document are subject to Mini-Circuit's standard limited warranty and terms and conditions (collectively, "Standard Terms"); Purchasers of this part are entitled to the rights and benefits contained therein. For a full statement of the Standard Terms and the exclusive rights and remedies thereunder, please visit Mini-Circuit's website at www.minicircuits.com/WCLStore/terms.jsp

Mini-Circuits

www.minicircuits.com P.O. Box 350166, Brooklyn, NY 11235-0003 (718) 934-4500 sales@minicircuits.com

REV. C
M151107
ZFM-11+
DJ/TD/CP
200811
Page 1 of 2

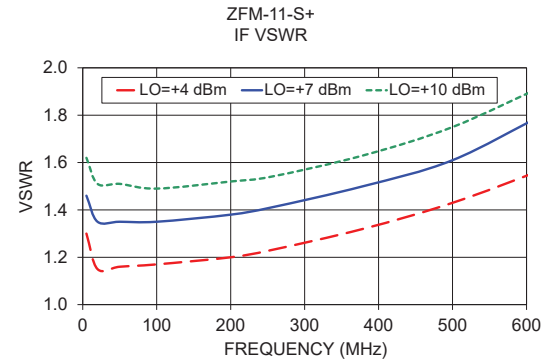
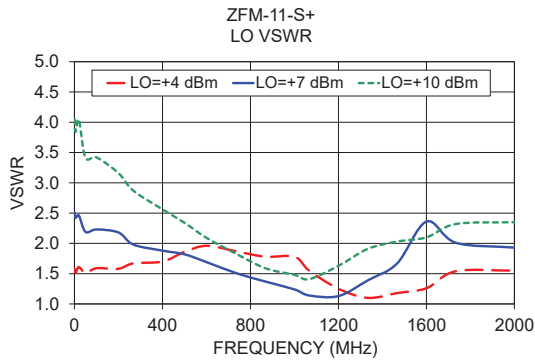
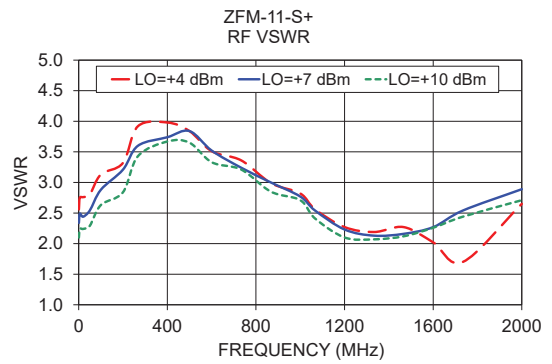
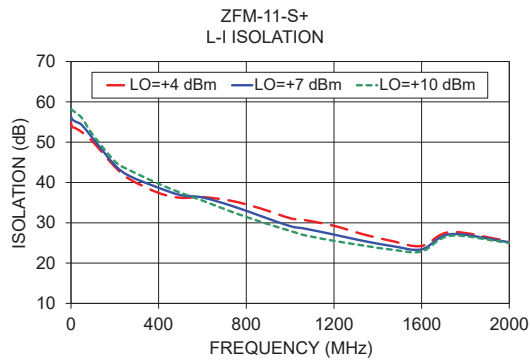
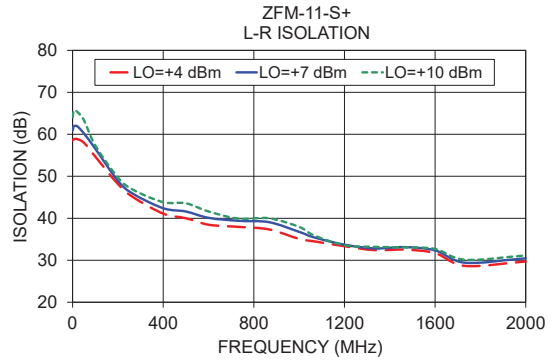
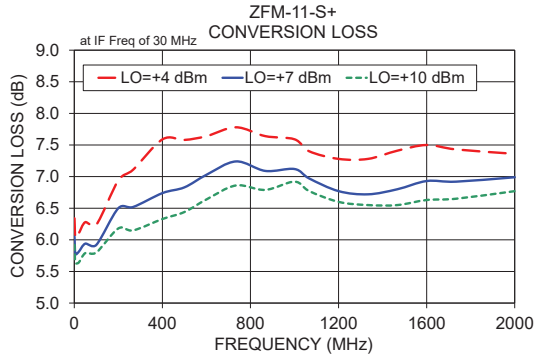

Notes

- A. Performance and quality attributes and conditions not expressly stated in this specification document are intended to be excluded and do not form a part of this specification document.
- B. Electrical specifications and performance data contained in this specification document are based on Mini-Circuit's applicable established test performance criteria and measurement instructions.
- C. The parts covered by this specification document are subject to Mini-Circuits standard limited warranty and terms and conditions (collectively, "Standard Terms"); Purchasers of this part are entitled to the rights and benefits contained therein. For a full statement of the Standard Terms and the exclusive rights and remedies thereunder, please visit Mini-Circuits' website at www.minicircuits.com/MCLStore/terms.jsp

