

Best Selection

Fiber Sensor Best Selection Catalog

Start with Smart!

Easily select the most reliable Fiber Unit for your detection conditions.



Smart Fiber Amplifier Units

E3NX-FA Series

→ 68 Page

Addition of Infrared models, Analog output models and Communications models with wired outputs.



Smart Fiber Amplifier Units

E3X-ZV Series

→ 69 Page

A new fiber amplifier unit able to detect the "presence or absence" of workpieces with "solid stability" at an "amazing price".



Easy

Optimal Fiber Sensor for additional Fiber Units for various Installation Conditions,

"Mounts Anywhere"

Wide Variety

Variouly-shaped, compact heads allow installation in any small space.

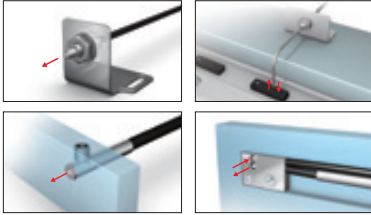

Suitable for Harsh Environments

Fiber Units are available for various installation conditions and can be installed as is, even in harsh environments.

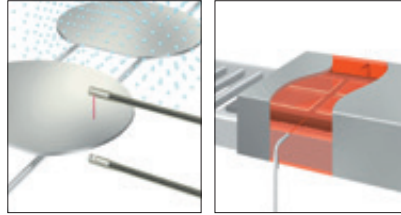

"Achieve Easy Detection in Many Applications"

Smart Tuning

Just press the button to set the optimum incident level and threshold. Consistent settings are achieved for all users with this ultra-easy procedure.



Press the **TUNE** button **once** with a workpiece and **once** without a workpiece

Automatic Setting of Optimum Values

Threshold + Incident Level

5000 9999

Set to the intermediate value between the incident levels with and without a workpiece. Incident level adjustment with and without a workpiece

Optimum Light Intensity Adjustment from Transparent Objects to Black Workpieces

The incident level is optimized to enable stable detection even for saturated or insufficient incident levels.

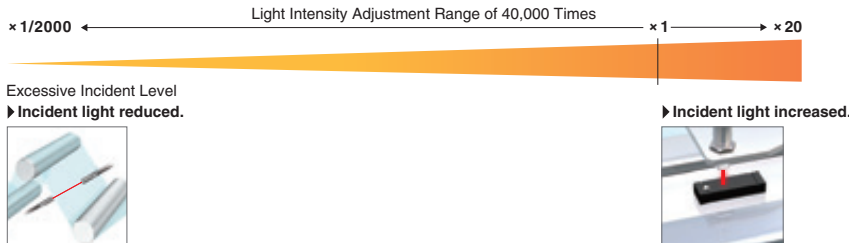

Smart Fiber Amplifier Units E3NX-FA

68, 70 Page

"Smooth Wiring and Setting"

Reduced Wiring

Simply link the Fiber Amplifier Units together for easy wiring and checking.

Separate Installation

Use the Distributed Sensor Unit for distributed installation to reduce introduction costs and work.

Easy Setup

Commissioning time is reduced with batch setting from a Touch Panel or backup data for process switchovers.



Fiber

'Easy' and 'Stable' for

installation when starting production.

Fiber Amplifier Units with easy optimum setting

Stable

Fiber Units E32

06
Page



"Expanded Application Response Capabilities"

Improved Basic Performance

Improvements in the sensing distance and minimum sensing object increase the range of application for stable detection.

1.5 Times
the Sensing Distance*

6 m

For E32-LT11 Fiber Unit with a fiber length of 3.5 m

1/10th
the Minimum Sensing Object*

0.3 μm dia.

Typical example of actual measurements with E32-D11R Fiber Unit.

*Compared to E3X-ZV.

Sensor Communications Units E3NW

EtherCAT
CC-Link V2

68, 70
Page

Sensor

Minimal Cost Process.

Basic Features of Fiber Sensors

Ideal for narrow spaces or for detecting minute objects.

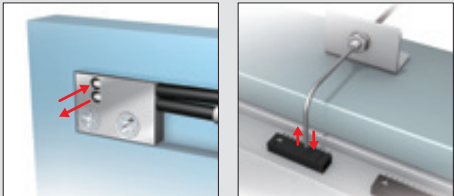

Digital display achieves visual control and quantitative control.

Conventional Photoelectric Sensor with Built-in Amplifier

Set the threshold by a sensitivity adjuster / Check the operation by an indicator.



- Ambiguous standard (e.g., 3/4 turn of adjuster)
- Indicator does not show the present value.

Fiber Sensor

Quantitative control over threshold settings with a digital display.

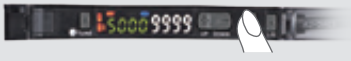

- The reference value can be set numerically for easier specification.
- Easily perceivable present value.

Selection by Category

STEP 1

Select a Fiber Unit.

Select a category.
Fiber Unit Index
05 Page

Select a model.
Category Pages
06 to 66 Page

STEP 2

Select a Fiber Amplifier Unit and Communications Unit.
68 Page

STEP 3

Select Accessories of Fiber Amplifier Unit
71,87 Page



Before Selecting Fiber Units

The Fiber Units specifications give the sensing distance when the Fiber Unit and Fiber Amplifier Unit is combined. Check the Fiber Amplifier Unit series for easier selection.

<Specifications on Each Fiber Unit Category Page>

Appearance (mm)	Bending radius of cable	Sensing distance (mm)		Optical axis diameter (minimum sensing object)	Models
		E3X-ZV	E3NX-FA		
		GIGA-HS Other notes	GIGA-HS Other notes		
		2,000	3,000		
		87 - 1,300	87 - 1,300		
		700	1,000		E32-T11R 2M

Fiber Amplifier Unit Series

		E3X-ZV Series	E3NX-FA Series
			
Fiber Amplifier Unit specifications	Output	1 output	1 or 2 outputs (depending on the model)
	External input	Not supported	Supported or not supported (depending on the model)
	Response time	50 μs /250 μs/1 ms/16 ms (Default: 250 μs)	30 μs (32 μs)/250 μs/1 ms/16 ms (Default: 250 μs)
	Sensing distance (Giga-power mode)	E32-T11R 2,000 mm E32-D11R 840 mm	3,000 mm 1,260 mm
Minimum sensing object	E32-T11R 5 μm dia.	2 μm dia.	
Sensor Communications Unit application	Communications method (Sensor Communications Unit model)	—	EtherCAT (E3NW-ECT) CC-Link (E3NW-CCL)
	Applicable Sensors	—	Fiber Sensor (E3NX-FA0/FA10/FA40/FAH0) Laser Sensors (E3NC-LA0, E3NC-SA0) Contact-Type Sensor (E9NC-TA0)
Page listings	Ordering Information	86 Page	70 Page
	Ratings and Specifications	88 Page	72 Page
	Dimensions	89 Page	76 Page

Selection by Model

STEP 1

Search for the page in the model index.
102 Page

STEP 2

Search for the model on the corresponding pages.
Each Page

Fiber Unit Index

Standard Installation

Threaded Models



Standard screw-type installation. The Fiber Units is mounted into a drilled hole and secured with nuts.

06 Page

Hex-shaped Models



Easily mount tightening just one nut. The cable follows the wall, so extra space is not required.

10 Page

Cylindrical Models

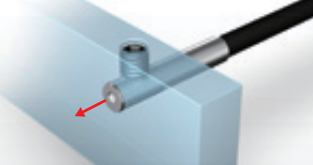

Ideal for installation in narrow spaces. The Fiber Unit is secured with a set screw.

12 Page

Saving Space

Flat Models



Mount directly in limited spaces without using special mounting brackets.

16 Page

Sleeve Models (Close-range Detection)

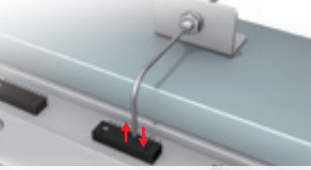

Suitable for close-range detection. Ideal for detecting minute objects in areas with limited space.

20 Page

Beam Improvements

Small-Spot, Reflective (Minute Object Detection)



Small-spot to accurately detect small objects.

24 Page

High-power Beam (Long-distance Installation, Dust-resistant)

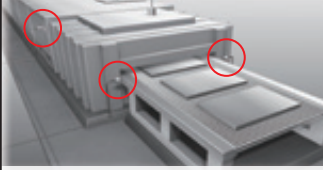

Suitable for detection on large equipment, of large objects, and in environments with airborne particles.

28 Page

Beam Improvements

Narrow View (Detection Across Clearance)



The Fiber Unit emit a non-spreading beam to prevent false detection of light reflected off surrounding objects.

34 Page

Detection without Background Interference



Detect only objects in the sensing range, and not in the background.

36 Page

Retro-reflective

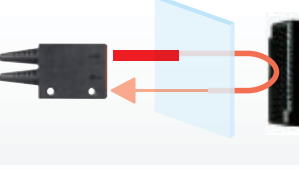

Detect transparent objects reliably because the beam passes through the object twice, resulting in greater light interruption.

38 Page

Limited-reflective (Glass Detection)

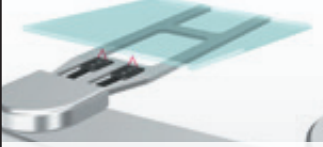

The limited-reflective optical system provides stable detection of specular reflective glass.

40 Page

Transparent Object Detection

Environmental Immunity

Chemical-resistant, Oil-resistant



Made from materials that are resistant to various oils and chemicals.

42 Page

Bending-resistant, Disconnection-resistant



Resistant to repeated bending on moving parts and breaking from snagging or shock.

44 Page

Heat-resistant

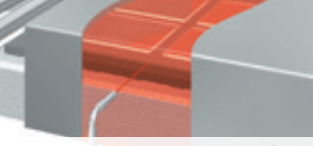

Can be used in high-temperature environments at up to 400°C.

48 Page

Special Applications

Area Beam (Area Detection)

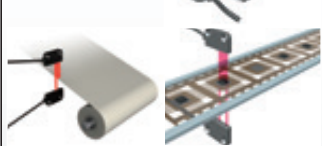

Detect across areas for meandering materials or falling workpieces whose position vary.

52 Page

Liquid-level Detection



Detect only liquid when being mounted on tubes or in liquid.

54 Page

Vacuum-resistant



Can be used under high vacuums of up to 10⁻⁵ Pa.

56 Page

FPD, Semiconductors, and Solar Cells



Designed specifically to reliably detect glass substrates and wafers.

58 Page

Fiber Sensor Features

Selection Guide

Fiber Units

Threaded
Hex-shaped
Cylindrical

Flat
Sleeved

Small Spot

High Power

Narrow view

BGS

Retro-reflective
Limited-reflective

Chemical-resistant,
Oil-resistant

Bending

Heat-resistant

Area Detection

Liquid-level

Vacuum

FPD,
Semi,
Solar

Installation Information

Fiber Amplifiers,
Communications
Unit, and
Accessories

Technical
Guide and
Precautions

Model Index

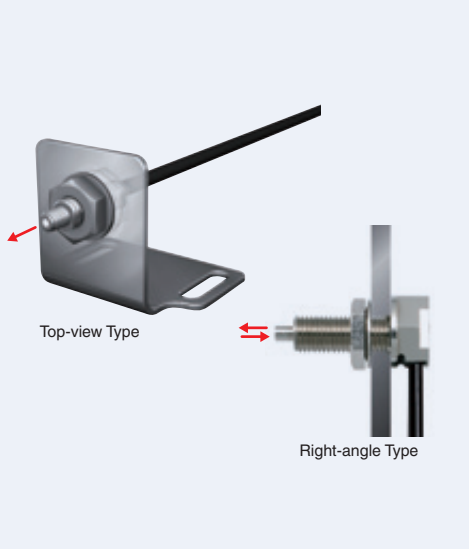

- Standard configuration. These Fiber Units are mounted into a hole drilled in a bracket and secured with nuts.
- The Right-angle Model prevents snagging on the cable because the cable runs along the mounting surface.

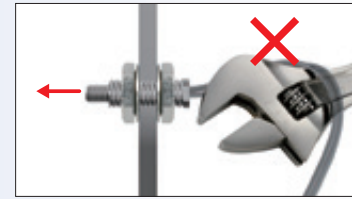
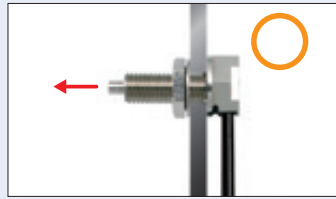

Specifications

Through-beam Fiber Units

Sensing direction (Aperture angle)	Size	Appearance (mm)	Bending radius of cable	Sensing distance (mm)				Optical axis diameter (minimum sensing object)	Models	07 Page Dimensions No.
				E3X-ZV		E3NX-FA				
				GIGA	HS	GIGA	HS			
Right-angle (Approx. 60°)	M4		Flexible, R1	2,000	ST : 1,000	3,000	ST : 1,500	1 dia. (5 μm dia./ 2 μm dia.)	E32-T11N 2M	07-A
				700	SHS: 280	1,050	SHS: 280			
Top-view (Approx. 60°)	M4		R25	4,000*	ST : 4,000*	4,000*	ST : 4,000*	2.3 dia. (0.1 dia./ 0.03 dia.)	E32-LT11 2M	07-C
Top-view (Approx. 15°)	M4		Flexible, R1	2,700	SHS: 1,080	4,000*	SHS: 1,080			
				4,000*	ST : 3,500	4,000*	ST : 4,000*			
				2,300	SHS: 920	3,450	SHS: 920			

* The optical fiber is 2 m long on each side, so the sensing distance is 4,000 mm.

Note 1. The following mode names and response times apply to the modes given in the Sensing distance column.

[E3X-ZV] GIGA: Giga-power mode (16 ms), HS: High-speed mode (250 μs), ST: Standard mode (1 ms), and SHS: Super-high-speed mode (50 μs)

[E3NX-FA] GIGA: Giga-power mode (16 ms), HS: High-speed mode (250 μs), ST: Standard mode (1 ms), and SHS: Super-high-speed mode (30 μs)

2. The values for the minimum sensing object are reference values that indicate values obtained in standard mode with the sensing distance and sensitivity set to the optimum values.

The first value is for the E3X-ZV and the second value is for the E3NX-FA.

3. The sensing distances for E3NX-FA are values for E3NX-FA□ models. The distances for E3NX-FAH□ infrared models are different.

4. The E3X-HD Series offers the same sensing distance as the E3X-ZV.

Dimensions

Installation Information → 62 to 66 Page

Through-beam Fiber Units (Set of 2)

07-A E32-T11N 2M (Free Cutting)

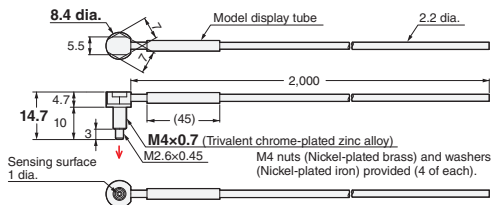

07-B E32-T11R 2M (Free Cutting)

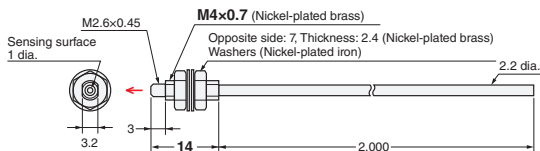

07-C E32-LT11 2M (Free Cutting)

E32-LT11R 2M (Free Cutting)

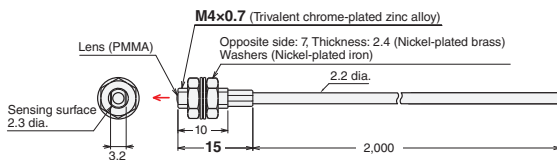

- Reference Information for Model Selection -

Features of the Right-angle Type

- Cable is less prone to snagging.
- Cable runs along the mounting surface for less space compared with Top-view Fiber Units.
- The nut is attached to the Fiber Unit to reduce installation work.

What Is "Flexible" Fiber?

The flexible fiber has a small bending radius for easy routing without easily breaking. It is easy to use because the cable can be bent without significantly reducing light intensity.



Build-in Lens

What Are Fiber Units with Build-in Lenses?

These Fiber Units have built-in lenses. They feature high-power beams. You don't have to worry about the lens falling off and getting lost.

And

Long-distance Sensing Applications

A separate Lens Unit can be attached to extend the sensing distance.
→ 30 Page

Breaking Due to Snagging or Shock

The Fiber Unit can be protected from breaking with stainless steel spiral tube.
→ 44 Page (Excluding the E32-T11N 2M.)

Fiber Sensor
Features

Selection
Guide

Fiber Units

Threaded	Standard Installation
Hex-shaped	
Cylindrical	
Flat	Saving Space
Sleeved	
Small Spot	Beam Improvements
High Power	
Narrow view	
BGS	
Retro-reflective	Transparent Objects
Limited-reflective	
Chemical-resistant, Oil-resistant	Environmental Immunity
Bending	
Heat-resistant	
Area Detection	
Liquid-level	Applications
Vacuum	
FPD, Semi, Solar	

Installation
Information

Fiber Amplifiers,
Communications
Unit, and
Accessories

Technical
Guide and
Precautions

Model Index

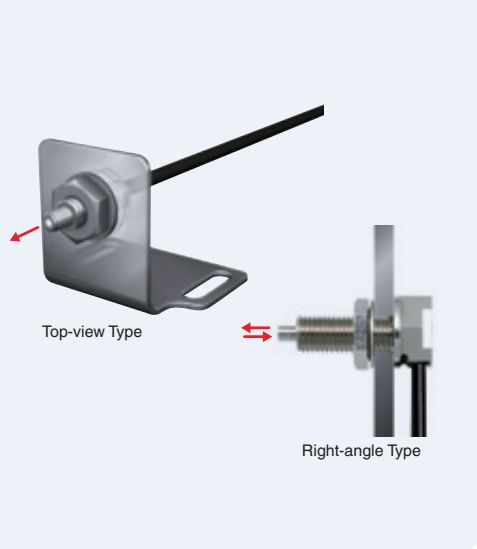

- Standard configuration. These Fiber Units are mounted into a hole drilled in a bracket and secured with nuts.
- The Right-angle Model prevents snagging on the cable because the cable runs along the mounting surface.

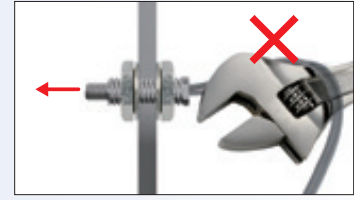
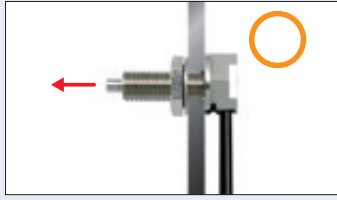

Specifications

Reflective Fiber Units

Sensing direction (Aperture angle)	Size	Appearance (mm)	Bending radius of cable	Sensing distance (mm)				Optical axis diameter (minimum sensing object)	Models	09 Page Dimensions No.
				E3X-ZV		E3NX-FA				
				GIGA	HS	Other modes	GIGA			
Right-angle (Approx. 60°)	M3		Flexible, R4	110 46	ST : 50 SHS: 14	160 69	ST : 75 SHS: 14	5 μm dia./ 2 μm dia.)	E32-C31N 2M	09-A
	M6		Flexible, R4	780 220	ST : 350 SHS: 100	1,170 340	ST : 520 SHS: 100		E32-C91N 2M	09-B
Top-view (Approx. 60°)	M3		Flexible, R1	140 40	ST : 60 SHS: 16	210 60	ST : 90 SHS: 16	5 μm dia./ 2 μm dia.)	E32-D21R 2M	09-C
			R25	330	ST : 150 SHS: 44	490 150	ST : 220 SHS: 44		E32-C31 2M	09-D
			R10	100	ST : 150 SHS: 44	490 150	ST : 220 SHS: 44		E32-C31M 1M	09-E
	M4		Flexible, R1	140 40	ST : 60 SHS: 16	210 60	ST : 90 SHS: 16		E32-D211R 2M	09-F
	M6		Flexible, R1	840 240	ST : 350 SHS: 100	1,260 360	ST : 520 SHS: 100		E32-D11R 2M	09-G
			R25	1,400 400	ST : 600 SHS: 180	2,100 600	ST : 900 SHS: 180		E32-CC200 2M	09-H
Top-view (Approx. 15°)	M6		R25	860 250	ST : 360 SHS: 110	1,290 370	ST : 540 SHS: 110	(1 dia./ 0.03 dia.)	E32-LD11 2M	09-I
			Flexible, R1	840 240	ST : 350 SHS: 100	1,260 360	ST : 520 SHS: 100		E32-LD11R 2M	

Note 1. The following mode names and response times apply to the modes given in the Sensing distance column.
 [E3X-ZV] GIGA: Giga-power mode (16 ms), HS: High-speed mode (250 μs), ST: Standard mode (1 ms), and SHS: Super-high-speed mode (50 μs)
 [E3NX-FA] GIGA: Giga-power mode (16 ms), HS: High-speed mode (250 μs), ST: Standard mode (1 ms), and SHS: Super-high-speed mode (30 μs)
 2. The values for the minimum sensing object are reference values that indicate values obtained in standard mode with the sensing distance and sensitivity set to the optimum values. The first value is for the E3X-ZV and the second value is for the E3NX-FA.
 3. The sensing distances for Reflective Fiber Units are for white paper. (The sensing distance for the E32-LD11 2M / E32-LD11R 2M are for glossy white paper.)
 4. The sensing distances for E3NX-FA are values for E3NX-FA□ models. The distances for E3NX-FAH□ infrared models are different.
 5. The E3X-HD Series offers the same sensing distance as the E3X-ZV.

Dimensions

Installation Information → 62 to 66 Page

Reflective Fiber Units

09-A E32-C31N 2M (Free Cutting)

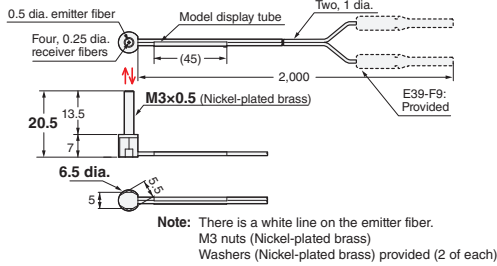

09-B E32-C91N 2M (Free Cutting)

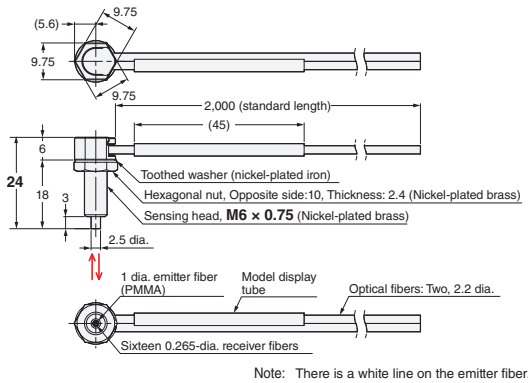

09-C E32-D21R 2M (Free Cutting)

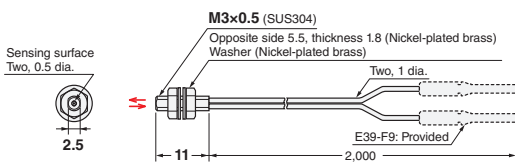

09-D E32-C31 2M (Free Cutting)

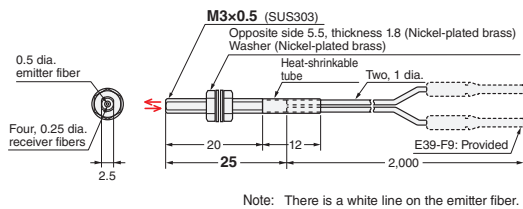

09-E E32-C31M 1M (Free Cutting)

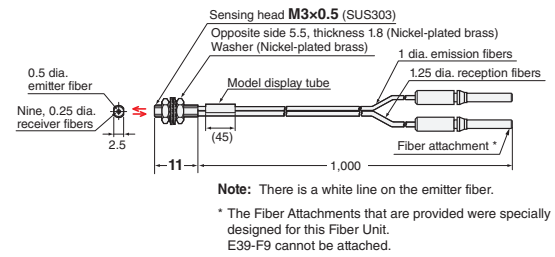

09-F E32-D211R 2M (Free Cutting)

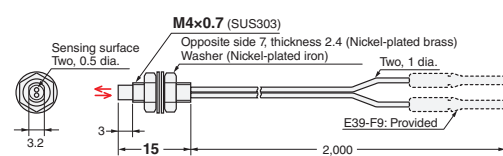

09-G E32-D11R 2M (Free Cutting)

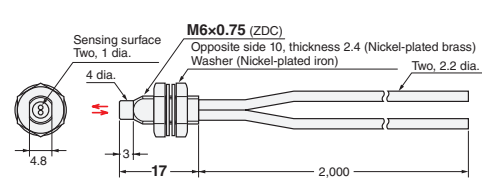

09-H E32-CC200 2M (Free Cutting)

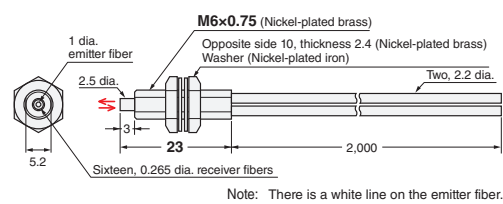

09-I E32-LD11 2M (Free Cutting)

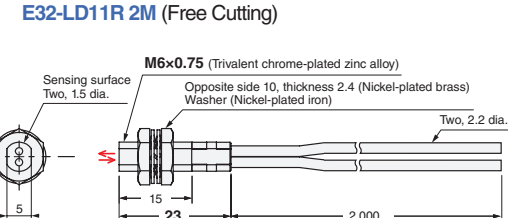

- Reference Information for Model Selection -

Features of Coaxial Reflective Type

These Fiber Units offer better detection of small objects at close distances (of 2 mm or less) than Standard Reflective Fiber Units. They also detect glossy surfaces more reliably than Standard Reflective Fiber Units, even if the surface is tilted. The receiver fibers are arranged around the emitter fiber as shown below.

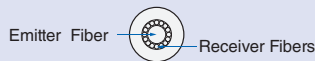

Features of the Right-angle Type

- Cable is less prone to snagging.
- Cable runs along the mounting surface for less space compared with Top-view Fiber Units.
- The nut is attached to the Fiber Unit to reduce installation work.

What Is "Flexible" Fiber?

The flexible fiber has a small bending radius for easy routing without easily breaking. It is easy to use because the cable can be bent without significantly reducing light intensity.

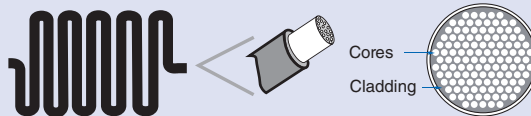

Structure which has a cladding around a large number of ultrafine cores.

Build-in Lens

What Are Fiber Units with Build-in Lenses?

These Fiber Units have built-in lenses. They feature high-power beams. You don't have to worry about the lens falling off and getting lost.

And

Breaking Due to Snagging or Shock

The Fiber Unit can be protected from breaking with stainless steel spiral tube.

→ 46 Page

Fiber Sensor Features

Selection Guide

Fiber Units

Threaded
Hex-shaped
Cylindrical

Flat
Sleeved

Small Spot
High Power

Narrow view
BGS

Retro-reflective
Limited-reflective

Chemical-resistant, Oil-resistant

Bending
Heat-resistant

Area Detection
Liquid-level

Vacuum

Installation Information

Fiber Amplifiers, Communications Unit, and Accessories

Technical Guide and Precautions

Model Index

- Threaded
- Hex-shaped**
- Cylindrical

- Flat
- Sleeved

- Small Spot
- High Power
- Narrow view
- BGS

- Retro-reflective
- Limited-reflective

- Chemical-resistant, Oil-resistant
- Bending
- Heat-resistant

- Area Detection
- Liquid-level
- Vacuum
- FPD, Semi, Solar

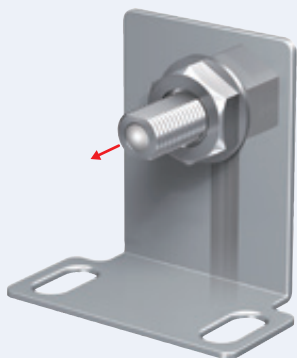

- You can easily mount these Fiber Units by making a hole in the bracket and tightening just one nut.
- The cable follows the wall, so extra space is not required, and the cable will not get caught on other objects.



- Build-in Lens**
A Fiber Unit with Build-in Lens is the new standard in fiber units. We recommend this new standard Fiber Unit that achieves stable detection with a high-power beam. You don't have to worry about the lens falling off and getting lost. Through-beam Flat Fiber Units are also available. (→ 16 page)

Specifications

Through-beam Fiber Units

Aperture angle	Size	Appearance (mm)	Bending radius of cable	Sensing distance (mm)				Optical axis diameter (minimum sensing object)	Models	11 Page Dimensions No.
				E3X-ZV		E3NX-FA				
				GIGA	HS	Other modes	GIGA			
Approx. 15°	M4		Flexible, R2	4,000*	ST : 3,500	4,000*	ST : 4,000*	2.3 dia. (0.1 dia./ 0.03 dia.)	E32-LT11N 2M	11-A
				2,300	SHS: 920	3,450	SHS: 920			
Approx. 60°	M4		Flexible, R1	2,000	ST : 1,000	3,000	ST : 1,500	1 dia. (5 μm dia./ 2 μm dia.)	E32-T11N 2M	11-B
				700	SHS: 280	1,050	SHS: 280			

Reflective Fiber Units

Aperture angle	Size	Appearance (mm)	Bending radius of cable	Sensing distance (mm)				Optical axis diameter (minimum sensing object)	Models	11 Page Dimensions No.
				E3X-ZV		E3NX-FA				
				GIGA	HS	Other modes	GIGA			
Approx. 15°	M6		Flexible, R2	840	ST : 350	1,260	ST : 520	(0.1 dia./ 0.03 dia.)	E32-LD11N 2M	11-C
				240	SHS: 100	360	SHS: 100			
Approx. 60°	M3		Flexible, R2	290	ST : 130	440	ST : 190	(5 μm dia./ 2 μm dia.)	E32-C21N 2M	11-D
	M4			840	ST : 350	1,260	ST : 520			
	M4			240	SHS: 100	360	SHS: 100			
	M6			780	ST : 350	1,170	ST : 520			
				220	SHS: 100	340	SHS: 100	(5 μm dia./ 2 μm dia.)	E32-C91N 2M	11-F

Retro-reflective Fiber Units (With M.S.R. Function)

Aperture angle	Size	Appearance (mm)	Bending radius of cable	Sensing distance (mm)				Optical axis diameter (minimum sensing object)	Models	11 Page Dimensions No.
				E3X-ZV		E3NX-FA				
				GIGA	HS	Other modes	GIGA			
Approx. 15°	M6		Flexible, R2	1,350	ST : 1,200	2,020	ST : 1,800	—	E32-LR11NP 2M + E39-RP1	11-G
				1,000	SHS: 550	1,500	SHS: 550			

* The optical fiber is 2 m long on each side, so the sensing distance is 4,000 mm.

Note 1. The following mode names and response times apply to the modes given in the Sensing distance column.

[E3X-ZV] GIGA: Giga-power mode (16 ms), HS: High-speed mode (250 μs), ST: Standard mode (1 ms), and SHS: Super-high-speed mode (50 μs)

[E3NX-FA] GIGA: Giga-power mode (16 ms), HS: High-speed mode (250 μs), ST: Standard mode (1 ms), and SHS: Super-high-speed mode (30 μs)

2. The values for the minimum sensing object are reference values that indicate values obtained in standard mode with the sensing distance and sensitivity set to the optimum values. The first value is for the E3X-ZV and the second value is for the E3NX-FA.

3. The sensing distances for Reflective Sensors are for white paper. (The sensing distances for the E32-LD11N 2M are for glossy white paper.)

4. With Retro-reflective Models, objects with a high reflection factor may cause the Fiber Sensor to detect reflected light as incident light. Also, stable detection may not be possible for transparent objects. Check suitability beforehand.

5. The E3X-HD Series offers the same sensing distance as the E3X-ZV.

Dimensions

Installation Information → 62 to 66 Page

Through-beam Fiber Units

11-A E32-LT11N 2M (Free Cutting)

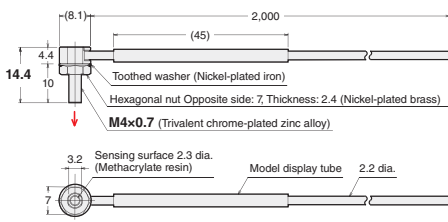

11-B E32-T11N 2M (Free Cutting)

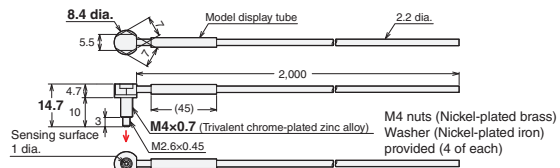

Reflective Fiber Units

11-C E32-LD11N 2M (Free Cutting)

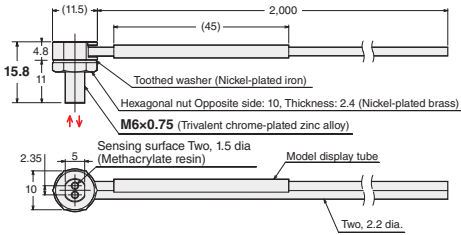

11-D E32-C21N 2M (Free Cutting)

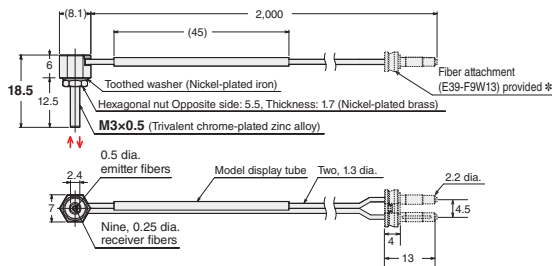

Note: There is a white line on the emitter fiber.
* Applicable Fiber Amplifier Units: E3NX-FA, E3NX-CA, and E3X-HD. Use the enclosed E39-F9-7 Fiber Attachment for other models, such as the E3X-SD, E3X-NA, and other models that have an 8-mm space between the emitter and receiver fiber insertion holes.

11-E E32-D21N 2M (Free Cutting)

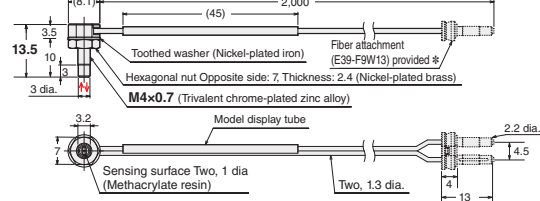

* Applicable Fiber Amplifier Units: E3NX-FA, E3NX-CA, and E3X-HD. Use the enclosed E39-F9-7 Fiber Attachment for other models, such as the E3X-SD, E3X-NA, and other models that have an 8-mm space between the emitter and receiver fiber insertion holes.

11-F E32-C91N 2M (Free Cutting)

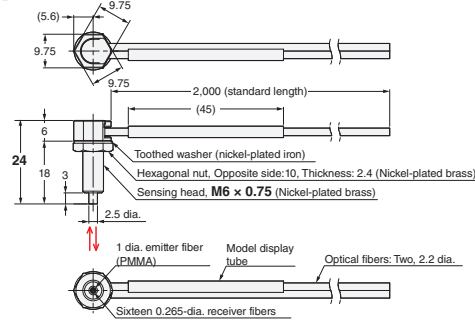

Note: There is a white line on the emitter fiber.

Retro-reflective Fiber Units (With M.S.R. Function)

11-G E32-LR11NP 2M (Free Cutting)

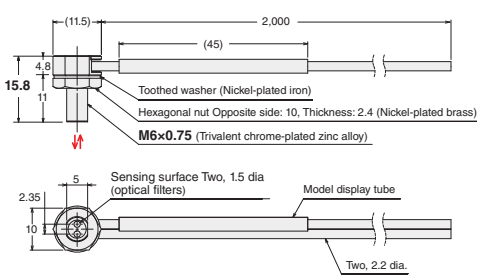

E39-RP1

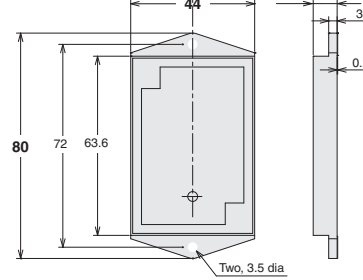

Material:
-<Reflective surface> Methacrylate resin
-<Back> ABS

- Reference Information for Model Selection -

Features of Coaxial Reflective Type

These Fiber Units offer better detection of small objects at close distances (of 2 mm or less) than Standard Reflective Fiber Units. They also detect glossy surfaces more reliably than Standard Reflective Fiber Units, even if the surface is tilted. The receiver fibers are arranged around the emitter fiber as shown below.

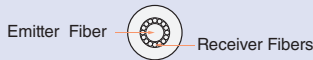

What Is "Flexible" Fiber?

The flexible fiber has a small bending radius for easy routing without easily breaking. It is easy to use because the cable can be bent without significantly reducing light intensity.

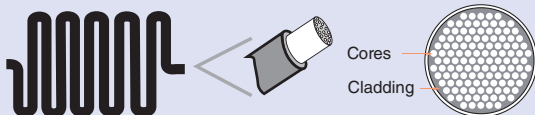

Structure which has a cladding around a large number of ultrafine cores.

Transparent Object Detection

Retro-reflective Models are ideal for detection of transparent objects.
→ 39 Page: Performance Comparison of Transparent Object Detection

And

Long-distance Sensing Applications with the E32-T11N

A separate Lens Unit can be attached to extend the sensing distance.
→ 30 Page

Fiber Sensor Features

Selection Guide

Fiber Units

Threaded
Hex-shaped
Cylindrical
Standard Installation

Flat
Sleeved
Saving Space

Small Spot
High Power
Narrow view
Beam Improvements

BGS
Retro-reflective
Limited-reflective
Transparent Objects

Chemical-resistant, Oil-resistant
Bending
Heat-resistant
Environmental Immunity

Area Detection
Liquid-level
Vacuum
Applications
FPD, Semi, Solar

Installation Information

Fiber Amplifiers, Communications Unit, and Accessories

Technical Guide and Precautions

Model Index

- Threaded
- Hex-shaped
- Cylindrical**

- Flat
- Sleeved

- Small Spot
- High Power
- Narrow view
- BGS

- Retro-reflective
- Limited-reflective

- Chemical-resistant, Oil-resistant
- Bending
- Heat-resistant

- Area Detection
- Liquid-level
- Vacuum
- FPD, Semi, Solar

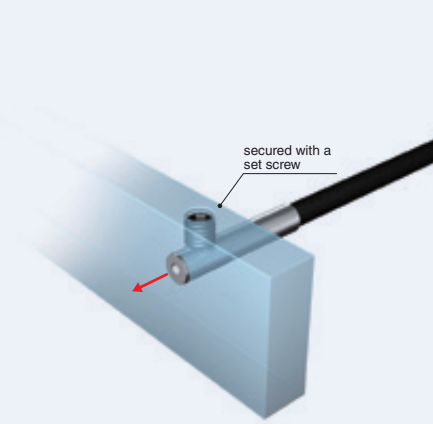

- Inserted where space is limited. (Secured using a set screw.)
- Ultraminate space-saving by micro-fiber head. (1 dia. × 10 mm)

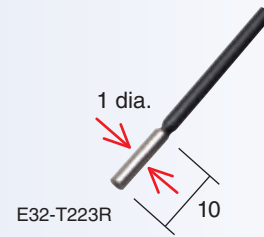

- Side-view models can be mounted where there is limited depth.

Specifications

Through-beam Fiber Units

Size	Sensing direction	Appearance (mm)	Bending radius of cable	Sensing distance (mm)				Optical axis diameter (minimum sensing object)	Models	13 Page Dimensions No.
				E3X-ZV		E3NX-FA				
				GIGA	HS	GIGA	HS			
1 dia.	Top-view		Flexible, R1	450	ST : 250	670	ST : 370	0.5 dia. (5 μm dia./ 2 μm dia.)	E32-T223R 2M	13-A
				150	SHS: 60	220	SHS: 60			
1.5 dia.	Top-view		Bendresistant, R4	680	ST : 400	1,020	ST : 600		E32-T22B 2M	13-B
				220	SHS: 90	330	SHS: 90			
3 dia.	Side-view		Flexible, R1	2,000	ST : 1,000	3,000	ST : 1,500	1 dia. (5 μm dia./ 2 μm dia.)	E32-T12R 2M	13-C
				700	SHS: 280	1,050	SHS: 280			
				750	ST : 450	1,120	ST : 670	E32-T14LR 2M	13-D	
				260	SHS: 100	390	SHS: 100			

- Note 1.** The following mode names and response times apply to the modes given in the Sensing distance column.
 [E3X-ZV] GIGA: Giga-power mode (16 ms), HS: High-speed mode (250 μs), ST: Standard mode (1 ms), and SHS: Super-high-speed mode (50 μs)
 [E3NX-FA] GIGA: Giga-power mode (16 ms), HS: High-speed mode (250 μs), ST: Standard mode (1 ms), and SHS: Super-high-speed mode (30 μs)
2. The values for the minimum sensing object are reference values that indicate values obtained in standard mode with the sensing distance and sensitivity set to the optimum values. The first value is for the E3X-ZV and the second value is for the E3NX-FA.
 3. The sensing distances for E3NX-FA are values for E3NX-FA□ models. The distances for E3NX-FAH□ infrared models are different.
 4. The E3X-HD Series offers the same sensing distance as the E3X-ZV.

Dimensions

Installation Information → 62 to 66 Page

Through-beam Fiber Units (Set of 2)

13-A E32-T223R 2M (Free Cutting)

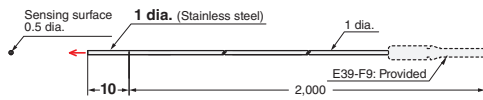

13-B E32-T22B 2M (Free Cutting)

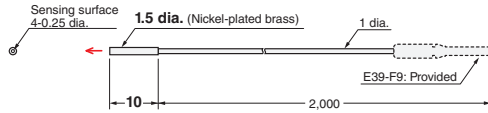

13-C E32-T12R 2M (Free Cutting)

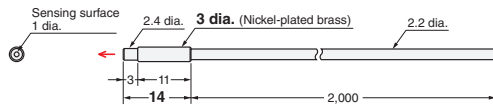

13-D E32-T14LR 2M (Free Cutting)

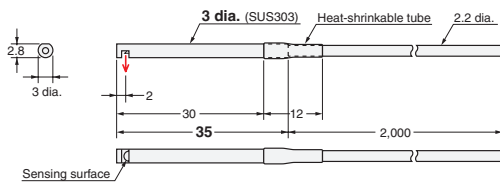

Fiber Sensor
Features

Selection
Guide

Fiber Units

Threaded
Hex-shaped
Cylindrical

Standard Installation

Flat
Sleeved

Saving Space

Small Spot
High Power
Narrow view
BGS

Beam Improvements

Retro-reflective
Limited-reflective

Transparent Objects

Chemical-resistant,
Oil-resistant

Environmental Immunity

Bending
Heat-resistant

Environmental Immunity

Area Detection

Liquid-level
Vacuum
FPD,
Semi,
Solar

Applications

Installation
Information

Fiber Amplifiers,
Communications
Unit, and
Accessories

Technical
Guide and
Precautions

Model Index

- Reference Information for Model Selection -

Recommended Mounting Hole Dimensions

The recommended mounting-hole dimensions for Cylindrical Fiber Units are given below.

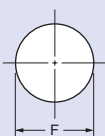

(Unit: mm)

Outer diameter of Fiber Unit	1 dia.	1.5 dia.	3 dia.
Dimension F	1.2 ^{+0.5} ₀ dia.	1.7 ^{+0.5} ₀ dia.	3.2 ^{+0.5} ₀ dia.

- Threaded
- Hex-shaped
- Cylindrical**

- Flat
- Sleeved

- Small Spot
- High Power
- Narrow view
- BGS

- Retro-reflective
- Limited-reflective

- Chemical-resistant, Oil-resistant
- Bending
- Heat-resistant

- Area Detection
- Liquid-level
- Vacuum
- FPD, Semi, Solar

- Inserted where space is limited. (Secured using a set screw.)

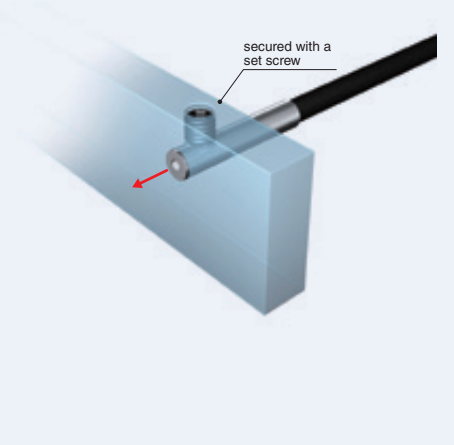

Specifications

Reflective Fiber Units

Size	Sensing direction	Appearance (mm)	Bending radius of cable	Sensing distance (mm)						Optical axis diameter (minimum sensing object)	Models	15 Page Dimensions No.
				E3X-ZV			E3NX-FA					
				GIGA	HS	Other modes	GIGA	HS	Other modes			
1.5 dia.	Top-view		Bend-resistant, R4	140		ST : 60	210		ST : 90	(5 μm dia./ 2 μm dia.)	E32-D22B 2M	15-A
			R4	28		ST : 12	42		ST : 18			
1.5 dia. + 0.5 dia.	Top-view		Flexible, R1	140		ST : 60	210		ST : 90		E32-D22R 2M	15-C
			Bend-resistant, R4	300		ST : 140	450		ST : 210			
3 dia.	Top-view		Coaxial	700		ST : 300	1,050		ST : 450		E32-D32L 2M	15-E
			R25	200		SHS: 90	300		SHS: 90			
3 dia. + 0.8 dia.	Top-view		R25	70		ST : 30	100		ST : 45		E32-D33 2M	15-F
			R25	20		SHS: 8	30		SHS: 8			
6 dia.	Side-view		Flexible, R1	220		ST : 100	330		ST : 150	E32-D14LR 2M	15-G	

Note 1. The following mode names and response times apply to the modes given in the Sensing distance column.

[E3X-ZV] GIGA: Giga-power mode (16 ms), HS: High-speed mode (250 μs), ST: Standard mode (1 ms), and SHS: Super-high-speed mode (50 μs)
 [E3NX-FA] GIGA: Giga-power mode (16 ms), HS: High-speed mode (250 μs), ST: Standard mode (1 ms), and SHS: Super-high-speed mode (30 μs)

2. The values for the minimum sensing object are reference values that indicate values obtained in standard mode with the sensing distance and sensitivity set to the optimum values. The first value is for the E3X-ZV and the second value is for the E3NX-FA.
3. The sensing distances for Reflective Fiber Units are for white paper.
4. The sensing distances for E3NX-FA are values for E3NX-FA□ models. The distances for E3NX-FAH□ infrared models are different.
5. The E3X-HD Series offers the same sensing distance as the E3X-ZV.

Dimensions

Installation Information → 62 to 66 Page

Reflective Fiber Units

15-A E32-D22B 2M (No Cutting)

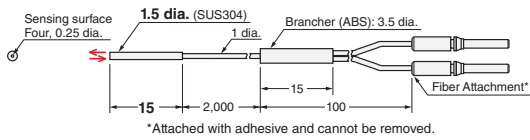

* Attached with adhesive and cannot be removed.

Enlarged View of Sensing Surface

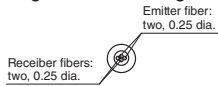

15-B E32-D43M 1M (No Cutting)

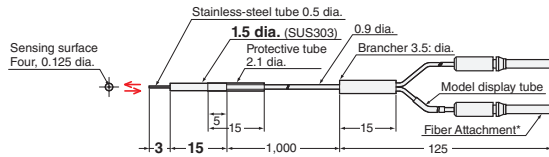

* Attached with adhesive and cannot be removed.

15-C E32-D22R 2M (Free Cutting)

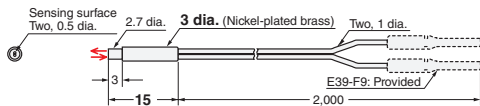

15-D E32-D221B 2M (Free Cutting)

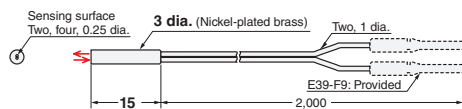

15-E E32-D32L 2M (Free Cutting)

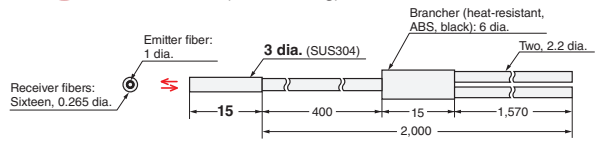

Note: There is a yellow dotted line on the Emitter fiber.

15-F E32-D33 2M (Free Cutting)

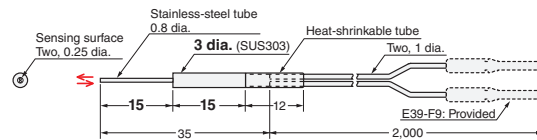

15-G E32-D14LR 2M (Free Cutting)

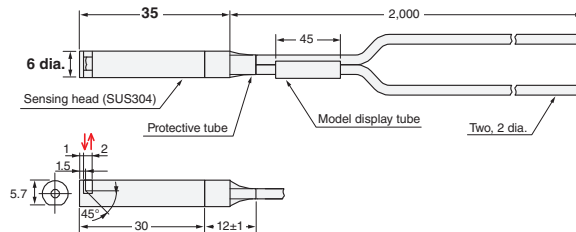

Fiber Sensor Features

Selection Guide

Fiber Units

Threaded	Standard Installation
Hex-shaped	
Cylindrical	
Flat	Saving Space
Sleeved	
Small Spot	Beam Improvements
High Power	
Narrow view	
BGS	Transparent Objects
Retro-reflective	
Limited-reflective	
Chemical-resistant, Oil-resistant	Environmental Immunity
Bending	
Heat-resistant	
Area Detection	Applications
Liquid-level	
Vacuum	
FPD, Semi, Solar	

- Reference Information for Model Selection -

Features of Coaxial Reflective Type

These Fiber Units offer better detection of small objects at close distances (of 2 mm or less) than Standard Reflective Fiber Units. They also detect glossy surfaces more reliably than Standard Reflective Fiber Units, even if the surface is tilted. The receiver fibers are arranged around the emitter fiber as shown below.



Recommended Mounting Hole Dimensions

The recommended mounting-hole dimensions for Cylindrical Fiber Units are given below.

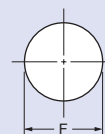

(Unit: mm)

Outer diameter of Fiber Unit	1.5 dia.	3 dia.
Dimension F	1.7 ^{+0.5} ₀ dia.	3.2 ^{+0.5} ₀ dia.

Installation Information

Fiber Amplifiers, Communications Unit, and Accessories

Technical Guide and Precautions

Model Index

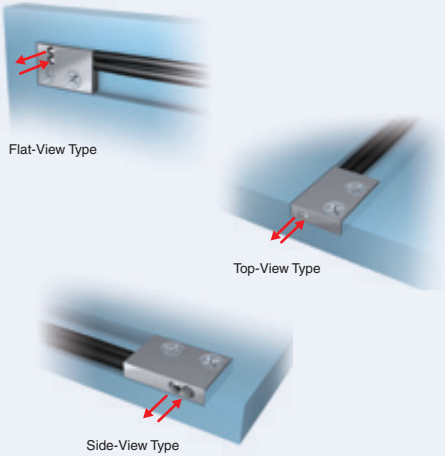

- Thin profile for mounting in limited spaces.
- Mounts directly without using special mounting brackets.

Specifications

Through-beam Fiber Units

Sensing direction	Appearance (mm)	Bending radius of cable	Sensing distance (mm)				Optical axis diameter (minimum sensing object)	Models	17 Page Dimensions No.
			E3X-ZV		E3NX-FA				
			GIGA	HS	GIGA	HS			
Top-view		Flexible, R1	2,000	ST : 1,000	3,000	ST : 1,500	1 dia. (5 μm dia./ 2 μm dia.)	E32-T15XR 2M	17-A
			700	SHS: 280	1,050	SHS: 280			
Side-view		Flexible, R1	450	ST : 250	670	ST : 370	0.5 dia. (5 μm dia./ 2 μm dia.)	E32-T25XR 2M	17-B
			150	SHS: 60	220	SHS: 60			
Flat-view		Flexible, R1	750	ST : 450	1,120	ST : 670	1 dia. (5 μm dia./ 2 μm dia.)	E32-T15ZR 2M	17-E
			260	SHS: 20	390	SHS: 100			
Flat-view		Flexible, R1	170	ST : 100	250	ST : 150	0.5 dia. (5 μm dia./ 2 μm dia.)	E32-T25ZR 2M	17-F
			50	SHS: 20	70	SHS: 20			
Flat-view		Flexible, R1	2,400	ST : 1,200	3,600	ST : 1,800	3 dia. (0.1 dia./ 0.03 dia.)	E32-LT35Z 2M	17-G
			800	SHS: 300	1,200	SHS: 300			

Note 1. The following mode names and response times apply to the modes given in the Sensing distance column.
 [E3X-ZV] GIGA: Giga-power mode (16 ms), HS: High-speed mode (250 μs), ST: Standard mode (1 ms), and SHS: Super-high-speed mode (50 μs)
 [E3NX-FA] GIGA: Giga-power mode (16 ms), HS: High-speed mode (250 μs), ST: Standard mode (1 ms), and SHS: Super-high-speed mode (30 μs)

2. The values for the minimum sensing object are reference values that indicate values obtained in standard mode with the sensing distance and sensitivity set to the optimum values. The first value is for the E3X-ZV and the second value is for the E3NX-FA.

3. The sensing distances for Reflective Fiber Units are for white paper.

4. The sensing distances for E3NX-FA are values for E3NX-FA□ models. The distances for E3NX-FAH□ infrared models are different.

5. The E3X-HD Series offers the same sensing distance as the E3X-ZV.

Dimensions

Installation Information → 62 to 66 Page

Through-beam Fiber Units (Set of 2)

17-A E32-T15XR 2M (Free Cutting)

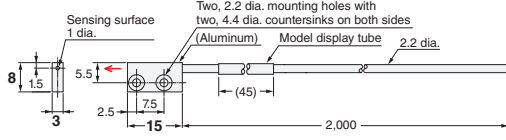

Note: 1. Set of two symmetrically shaped Fiber Units.
2. Four, M2 x 8 stainless steel countersunk mounting screws are provided.

17-B E32-T25XR 2M (Free Cutting)

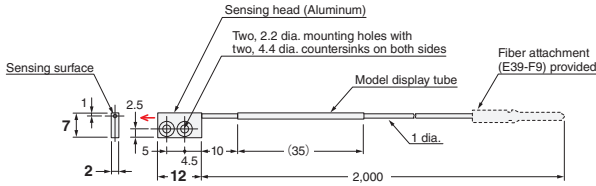

Note: 1. Set of two symmetrically shaped Fiber Units.
2. Four, M2 x 8 stainless steel countersunk mounting screws are provided.

17-C E32-T15YR 2M (Free Cutting)

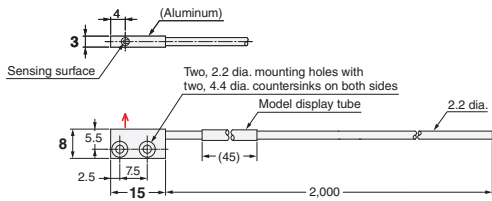

Note: 1. Set of two symmetrically shaped Fiber Units.
2. Four, M2 x 8 stainless steel countersunk mounting screws are provided.

17-D E32-T25YR 2M (Free Cutting)

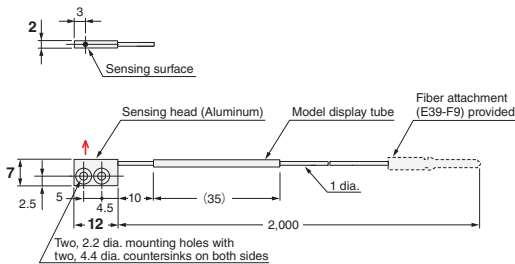

Note: 1. Set of two symmetrically shaped Fiber Units.
2. Four, M2 x 8 stainless steel countersunk mounting screws are provided.

17-E E32-T15ZR 2M (Free Cutting)

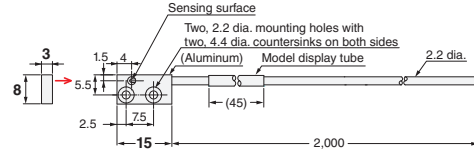

Note: 1. Set of two symmetrically shaped Fiber Units.
2. Four, M2 x 8 stainless steel countersunk mounting screws are provided.

17-F E32-T25ZR 2M (Free Cutting)

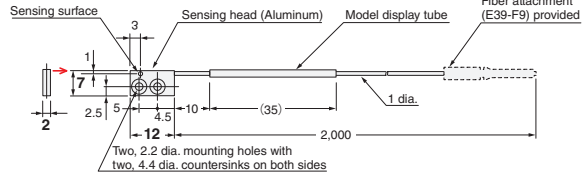

Note: 1. Set of two symmetrically shaped Fiber Units.
2. Four, M2 x 8 stainless steel countersunk mounting screws are provided.

17-G E32-LT35Z 2M (Free Cutting)

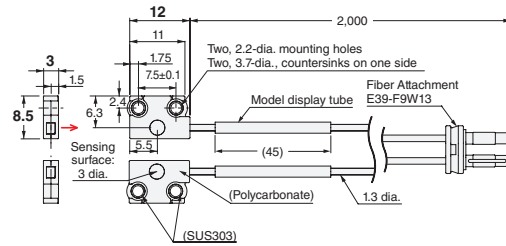

Note: 1. Set of two symmetrically shaped Fiber Units.
2. Four, M2 x 8 stainless-steel, pan-head mounting screws, four spring washers, four flat washers, and four nuts are provided.

Fiber Sensor Features

Selection Guide

Fiber Units

Threaded
Hex-shaped
Cylindrical

Flat
Sleeved

Standard Installation

Saving Space

Small Spot

High Power

Narrow view

Beam Improvements

BGS

Retro-reflective

Limited-reflective

Transparent Objects

Chemical-resistant, Oil-resistant

Bending

Heat-resistant

Environmental Immunity

Area Detection

Liquid-level

Vacuum

Applications

FPD, Semi, Solar

Installation Information

Fiber Amplifiers, Communications Unit, and Accessories

Technical Guide and Precautions

Model Index

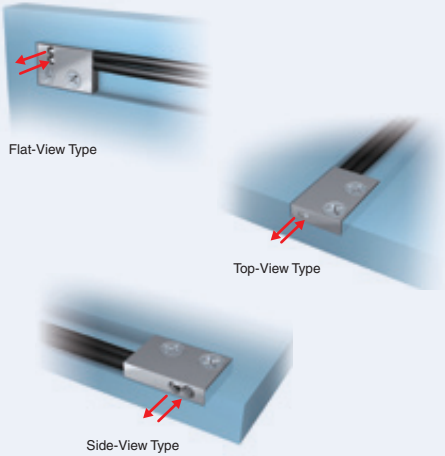

- Thin profile for mounting in limited spaces.
- Mounts directly without using special mounting brackets.

Specifications

Reflective Fiber Units

Sensing direction	Appearance (mm)	Bending radius of cable	Sensing distance (mm)						Optical axis diameter (minimum sensing object)	Models	19 Page Dimensions No.
			E3X-ZV			E3NX-FA					
			GIGA	HS	Other modes	GIGA	HS	Other modes			
Top-view		Flexible, R1	840	350	1,260	520	(5 μm dia./ 2 μm dia.)	E32-D15XR 2M	19-A		
	240		SHS: 100	360	SHS: 100						
Side-view			140	ST : 60	210	ST : 90					
	40		SHS: 16	60	SHS: 16						
Flat-view			200	ST : 100	300	ST : 150					
	52		SHS: 24	78	SHS: 24						
Top-view		40	ST : 16	60	ST : 20						
	10	SHS: 4	10	SHS: 4							
Side-view		200	ST : 100	300	ST : 150						
	52	SHS: 24	78	SHS: 24							
Flat-view		40	ST : 16	60	ST : 20						
	10	SHS: 4	10	SHS: 4							

- Note 1.** The following mode names and response times apply to the modes given in the Sensing distance column.
 [E3X-ZV] GIGA: Giga-power mode (16 ms), HS: High-speed mode (250 μs), ST: Standard mode (1 ms), and SHS: Super-high-speed mode (50 μs)
 [E3NX-FA] GIGA: Giga-power mode (16 ms), HS: High-speed mode (250 μs), ST: Standard mode (1 ms), and SHS: Super-high-speed mode (30 μs)
- The values for the minimum sensing object are reference values that indicate values obtained in standard mode with the sensing distance and sensitivity set to the optimum values. The first value is for the E3X-ZV and the second value is for the E3NX-FA.
 - The sensing distances for Reflective Fiber Units are for white paper.
 - The sensing distances for E3NX-FA are values for E3NX-FA□ models. The distances for E3NX-FAH□ infrared models are different.
 - The E3X-HD Series offers the same sensing distance as the E3X-ZV.

Dimensions

Installation Information → 62 to 66 Page

Reflective Fiber Units

19-A E32-D15XR 2M (Free Cutting)

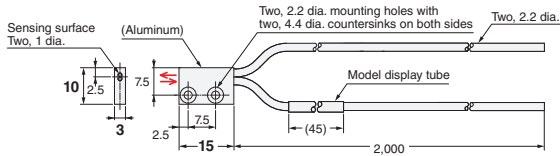

Note: Two, M2 x 8 stainless steel countersunk mounting screws are provided.

19-B E32-D25XR 2M (Free Cutting)

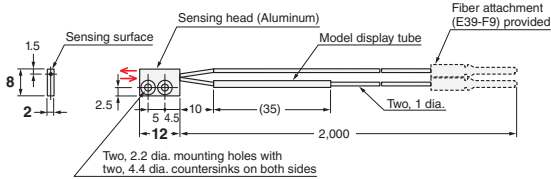

Note: Two, M2 x 8 stainless steel countersunk mounting screws are provided.

19-C E32-D15YR 2M (Free Cutting)

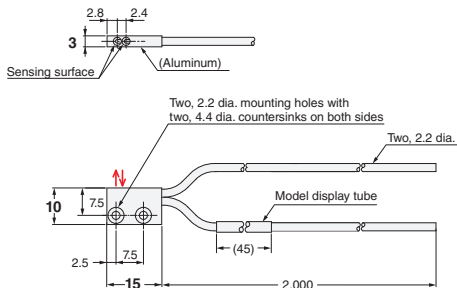

Note: Two, M2 x 8 stainless steel countersunk mounting screws are provided.

19-D E32-D25YR 2M (Free Cutting)

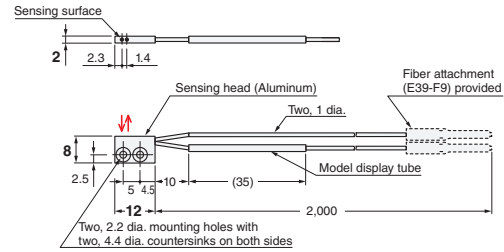

Note: Two, M2 x 8 stainless steel countersunk mounting screws are provided.

19-E E32-D15ZR 2M (Free Cutting)

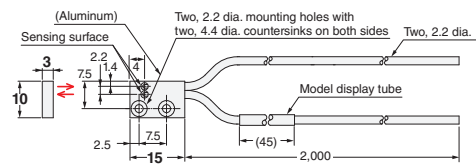

Note: Two, M2 x 8 stainless steel countersunk mounting screws are provided.

19-F E32-D25ZR 2M (Free Cutting)

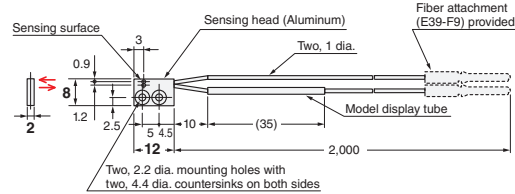

Note: Two, M2 x 8 stainless steel countersunk mounting screws are provided.

Fiber Sensor Features	
Selection Guide	
Fiber Units	
Threaded	Standard Installation
Hex-shaped	
Cylindrical	
Flat	Saving Space
Sleeved	
Small Spot	Beam Improvements
High Power	
Narrow view	
BGS	Transparent Objects
Retro-reflective	
Limited-reflective	
Chemical-resistant, Oil-resistant	Environmental Immunity
Bending	
Heat-resistant	
Area Detection	Applications
Liquid-level	
Vacuum	
FPD, Semi, Solar	

Installation Information

Fiber Amplifiers, Communications Unit, and Accessories

Technical Guide and Precautions

Model Index

- Threaded
- Hex-shaped
- Cylindrical

- Flat
- Sleeved**

- Small Spot
- High Power
- Narrow view
- BGS

- Retro-reflective
- Limited-reflective

- Chemical-resistant, Oil-resistant
- Bending
- Heat-resistant

- Area Detection
- Liquid-level
- Vacuum
- FPD, Semi, Solar

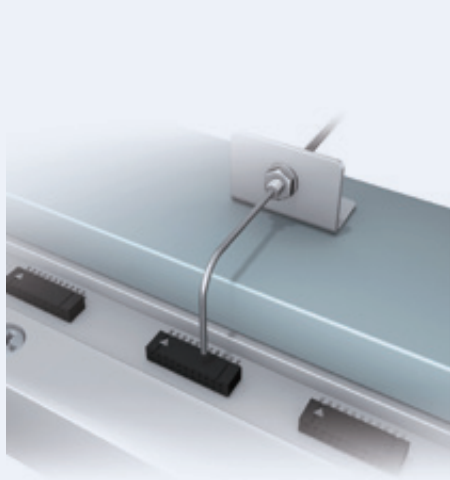

- Sleeve Fiber Units allow detection away from the point of installation for stable close-range detection of small objects.
- The shape of sleeve can be changed freely. (Refer to the sleeve bending specifications in the Appearance column of the specifications table.)

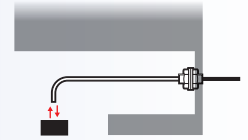

Specifications

Through-beam Fiber Units

Sensing direction	Appearance (mm)	Bending radius of cable	Sensing distance (mm)				Optical axis diameter (minimum sensing object)	Models	21 Page Dimensions No.
			E3X-ZV		E3NX-FA				
			GIGA	HS	Other modes	GIGA			
Side-view	The sleeve cannot be bent. 15 20 1 dia. 2 dia. IP67	Flexible, R1	170	ST : 100	250	ST : 150	0.5 dia. (5 μm dia./ 2 μm dia.)	E32-T24R 2M	21-A
	The sleeve cannot be bent. 15 15 0.81 dia. 2.5 dia. IP67	R10	450	ST : 250	670	ST : 370		E32-T24E 2M	21-B
Top-view	The sleeve cannot be bent. 15 40 3 dia. 0.5 dia. IP67		R10	150	ST : 90	220	ST : 130	0.25 dia. (5 μm dia./ 2 μm dia.)	E32-T33 1M
	The sleeve cannot be bent. 15 15 0.82 dia. M3 IP67	510		ST : 300	760	ST : 450	E32-T21-S1 2M		21-D
	Sleeve bending radius: 5 mm 11 90 1.2 dia. M4 IP67	Flexible, R1	2,000	ST : 1,000	3,000	ST : 1,500	1 dia. (5 μm dia./ 2 μm dia.)	E32-TC200BR 2M	21-E
	700	SHS : 280	1,050	SHS : 280					

Note 1. The following mode names and response times apply to the modes given in the Sensing distance column.

[E3X-ZV] GIGA: Giga-power mode (16 ms), HS: High-speed mode (250 μs), ST: Standard mode (1 ms), and SHS: Super-high-speed mode (50 μs)

[E3NX-FA] GIGA: Giga-power mode (16 ms), HS: High-speed mode (250 μs), ST: Standard mode (1 ms), and SHS: Super-high-speed mode (30 μs)

2. The values for the minimum sensing object are reference values that indicate values obtained in standard mode with the sensing distance and sensitivity set to the optimum values. The first value is for the E3X-ZV and the second value is for the E3NX-FA.
3. The sensing distances for E3NX-FA are values for E3NX-FA□ models. The distances for E3NX-FAH□ infrared models are different.
4. The E3X-HD Series offers the same sensing distance as the E3X-ZV.

Dimensions

Installation Information → 62 to 66 Page



Through-beam Fiber Units (Set of 2)

21-A E32-T24R 2M (Free Cutting)

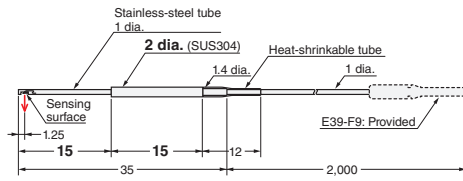

21-B E32-T24E 2M (Free Cutting)

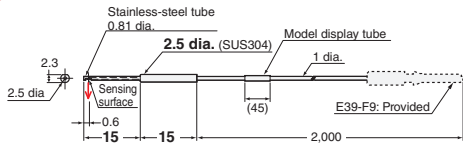

21-C E32-T33 1M (Free Cutting)

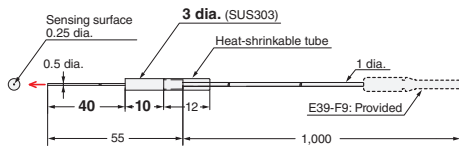

21-D E32-T21-S1 2M (Free Cutting)

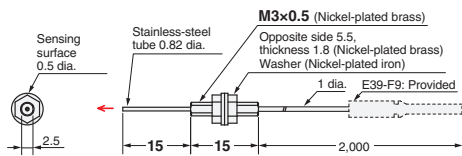

21-E E32-TC200BR 2M (Free Cutting)

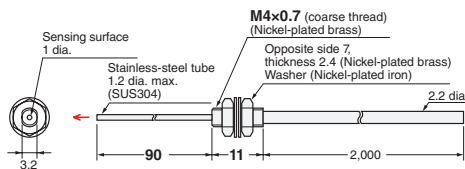

- Reference Information for Model Selection -

And

In case of bending sleeve

The E32-TC200BR has a bendable sleeve.
Use the Sleeve Bender to bend them.

Sleeve Bender (sold separately)

Appearance	Applicable Fiber Units	Model
Uses for the bending of the sleeve.	E32-TC200BR	E39-F11

Fiber Sensor Features

Selection Guide

Fiber Units

Threaded	Standard Installation
Hex-shaped	
Cylindrical	

Flat	Saving Space
Sleeved	

Small Spot	Beam Improvements
High Power	
Narrow view	
BGS	

Retro-reflective	Transparent Objects
Limited-reflective	

Chemical-resistant, Oil-resistant	Environmental Immunity
Bending	
Heat-resistant	

Area Detection	Applications
Liquid-level	
Vacuum	
FPD, Semi, Solar	

Installation Information

Fiber Amplifiers, Communications Unit, and Accessories

Technical Guide and Precautions

Model Index

- Threaded
- Hex-shaped
- Cylindrical

- Flat
- Sleeved

- Small Spot
- High Power
- Narrow view
- BGS

- Retro-reflective
- Limited-reflective

- Bending
- Heat-resistant

- FPD, Semi, Solar

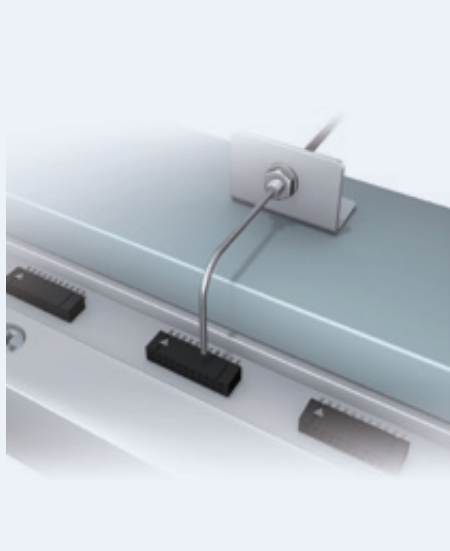



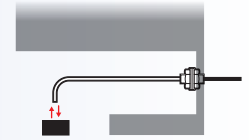

- Sleeve Fiber Units allow detection away from the point of installation for stable close-range detection of small objects.
- The shape of sleeve can be changed freely. (Refer to the sleeve bending specifications in the Appearance column of the specifications table.)

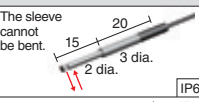
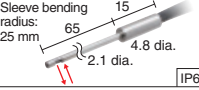

Specifications

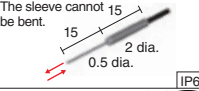
Reflective Fiber Units

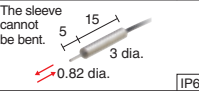
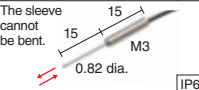
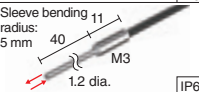
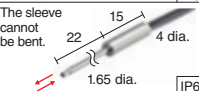
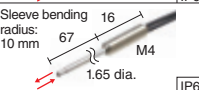
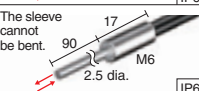
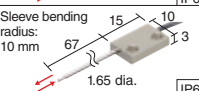
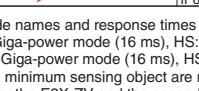
Sensing direction	Appearance (mm)	Bending radius of cable	Sensing distance (mm)						Optical axis diameter (minimum sensing object)	Models	23 Page Dimensions No.
			E3X-ZV			E3NX-FA					
			GIGA	HS	Other modes	GIGA	HS	Other modes			
Side-view	The sleeve cannot be bent. 	Flexible, R1	70	ST : 30	100	ST : 45	5 μm dia./ 2 μm dia.)	E32-D24R 2M	23-A		
	Sleeve bending radius: 25 mm. 	R25	120	ST : 53	180	ST : 79				E32-D24-S2 2M	23-B
	The sleeve cannot be bent. 	R4	28	ST : 12	42	ST : 18				E32-D43M 1M	23-C
Top-view	The sleeve cannot be bent. 	R4	14	ST : 6	21	ST : 9	E32-D331 2M	23-D			
	The sleeve cannot be bent. 	R4	4	SHS: 2	6	SHS: 2	E32-D33 2M	23-E			
	The sleeve cannot be bent. 	R25	70	ST : 30	100	ST : 45	E32-D32-S1 0.5M	23-F			
	The sleeve cannot be bent. 	R4	63	ST : 27	94	ST : 40	E32-D31-S1 0.5M	23-G			
	The sleeve cannot be bent. 	R4	18	SHS: 7	27	SHS: 7	E32-DC200F4R 2M	23-H			
	Sleeve bending radius: 5 mm. 	Flexible, R1	140	ST : 60	210	ST : 90	E32-D22-S1 2M	23-I			
	The sleeve cannot be bent. 	R10	250	ST : 110	370	ST : 160	E32-D21-S3 2M	23-J			
	Sleeve bending radius: 10 mm. 	R10	72	SHS: 30	100	SHS: 30	E32-DC200BR 2M	23-K			
	The sleeve cannot be bent. 	Flexible, R1	840	ST : 350	1,260	ST : 520	E32-D25-S3 2M	23-L			
	Sleeve bending radius: 10 mm. 	R10	250	ST : 110	370	ST : 160					

Note 1. The following mode names and response times apply to the modes given in the Sensing distance column.
 [E3X-ZV] GIGA: Giga-power mode (16 ms), HS: High-speed mode (250 μs), ST: Standard mode (1 ms), and SHS: Super-high-speed mode (50 μs)
 [E3NX-FA] GIGA: Giga-power mode (16 ms), HS: High-speed mode (250 μs), ST: Standard mode (1 ms), and SHS: Super-high-speed mode (30 μs)
2. The values for the minimum sensing object are reference values that indicate values obtained in standard mode with the sensing distance and sensitivity set to the optimum values. The first value is for the E3X-ZV and the second value is for the E3NX-FA. **3.** The sensing distances for Reflective Fiber Units are for white paper.
4. The sensing distances for E3NX-FA are values for E3NX-FA@ models. The distances for E3NX-FAH@ infrared models are different.
5. The E3X-HD Series offers the same sensing distance as the E3X-ZV.

Dimensions

Installation Information → 62 to 66 Page

Reflective Fiber Units

23-A E32-D24R 2M (Free Cutting)

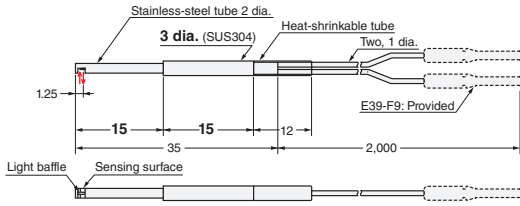

23-B E32-D24-S2 2M (Free Cutting)

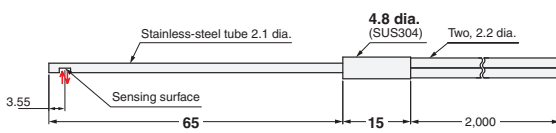

23-C E32-D43M 1M (No Cutting)

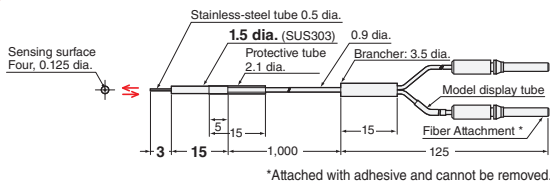

23-D E32-D331 2M (No Cutting)

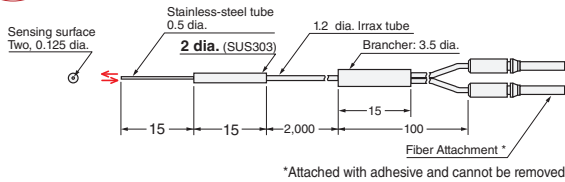

23-E E32-D33 2M (Free Cutting)

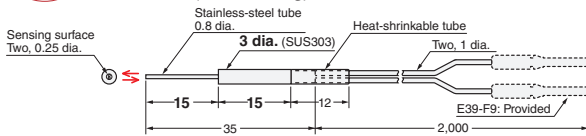

23-F E32-D32-S1 0.5M (No Cutting)

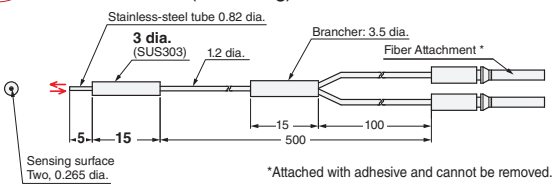

23-G E32-D31-S1 0.5M (No Cutting)

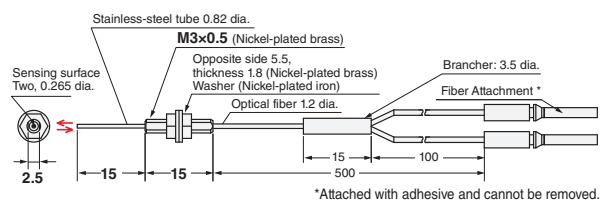

23-H E32-DC200F4R 2M (Free Cutting)

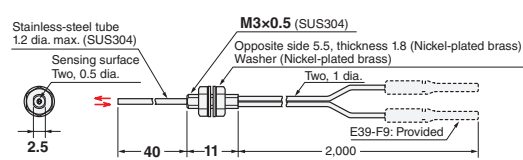

23-I E32-D22-S1 2M (Free Cutting)

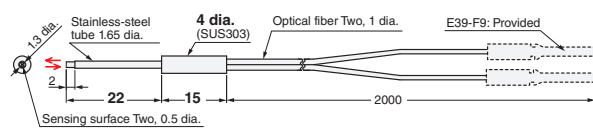

23-J E32-D21-S3 2M (Free Cutting)

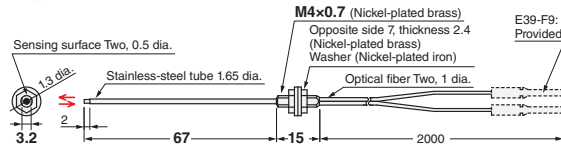

23-K E32-DC200BR 2M (Free Cutting)

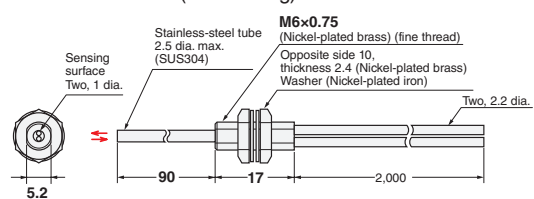

23-L E32-D25-S3 2M (Free Cutting)

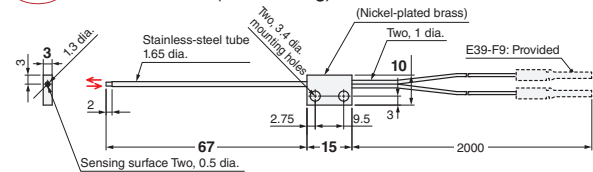

- Reference Information for Model Selection -

And

In case of bending sleeve

The E32-DC200F4R, E32-D21-S3 and E32-D25-S3 have bendable sleeves. Use the Sleeve Bender to bend them.

Sleeve Bender (sold separately)

Appearance	Applicable Fiber Units	Model
 Uses for the bending of the sleeve.	E32-DC200F4R E32-D21-S3 E32-D25-S3	E39-F11

Fiber Sensor Features

Selection Guide

Fiber Units

Threaded	Standard Installation
Hex-shaped	
Cylindrical	
Flat	Saving Space
Sleeved	
Small Spot	Beam Improvements
High Power	
Narrow view	
BGS	
Retro-reflective	Transparent Objects
Limited-reflective	
Chemical-resistant, Oil-resistant	Chemical Immunity
Bending	Environmental Immunity
Heat-resistant	
Area Detection	
Liquid-level	Applications
Vacuum	
FPD, Semi, Solar	

Installation Information

Fiber Amplifiers, Communications Unit, and Accessories

Technical Guide and Precautions

Model Index

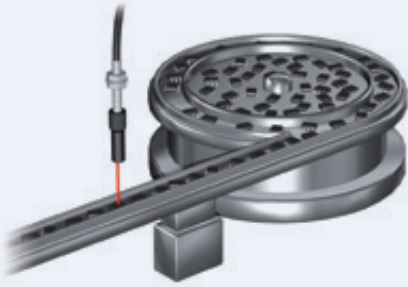

- Small-spot is ideal for detecting minute objects. Select the Fiber Unit that is best suited for the workpiece size and installation distance. (Refer to Reference Information for Model Selection)
- Available with a variable-spot Lens Unit to change the spot diameter without replacing the fiber. The spot diameter can be adjusted according to the size of the workpiece by changing the withdrew length and sensing distance. Refer to the following graph, which shows the relation between the withdrew length, focal distance, and spot diameter.

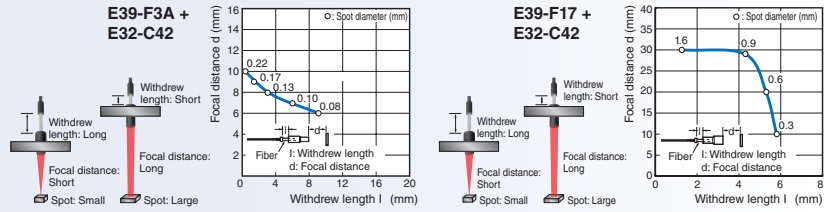

* Withdrew length: Approx. 1.3 to 5.8 mm

Specifications

Reflective Fiber Units

Variable-spot types

Lens Units + Fiber Unit

Type	Spot diameter	Center distance (mm)	Lens Units	Lens Units + Fiber Units	Fiber Unit		25 Page Dimensions No.
			Models	Appearance (mm)	Bending radius of cable	Model	
Variable spot	0.1 to 0.6 dia.	6 to 15	E39-F3A		R25	E32-C42 1M	25-A
	0.3 to 1.6 dia.	10 to 30	E39-F17				25-B

Parallel-light-spot types

Lens Units + Fiber Unit

Type	Spot diameter	Center distance (mm)	Lens Units	Lens Units + Fiber Units	Fiber Unit		25 Page Dimensions No.
			Model	Appearance (mm)	Bending radius of cable	Models	
Parallel light	4 dia.	0 to 20	E39-F3C		R25	E32-C31 2M	25-C
							Flexible, R2

Small-spot types

Integrated Lens

Type	Spot diameter	Center distance (mm)	Appearance (mm)	Bending radius of cable	Models	25 Page Dimensions No.
Short-distance, Small-spot	0.1 dia.	5		R25	E32-C42S 1M	25-E
Long-distance, Small-spot	6 dia.	50			E32-L15 2M	25-F

* The spot diameter and the center distance are the same when using with E3X-ZV series or E3NX-FA□ series. The distance for E3NX-FAH□ infrared models varies.

Dimensions

Installation Information → 62 to 66 Page

Reflective Fiber Units

25-A E32-C42 1M (No Cutting) + E39-F3A

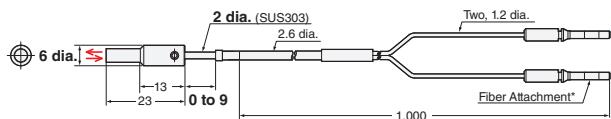

* Attached with adhesive and cannot be removed.
Note: There is a white tube on the emitter fiber.

E39-F3A

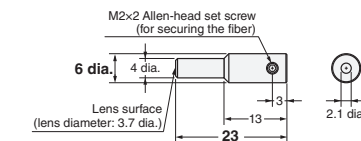

Material: Aluminum for body and optical glass for lens.
Note: This is the Lens Unit for the E32-C42.

25-B E32-C42 1M (No Cutting) + E39-F17

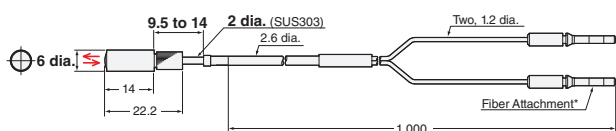

* Attached with adhesive and cannot be removed.
Note: There is a white tube on the emitter fiber.

E39-F17

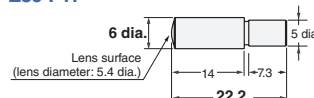

Material: Aluminum for body and optical glass for lens.

25-C E32-C31 2M (Free Cutting) + E39-F3C

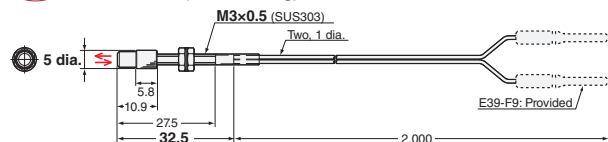

Note: There is a white line on the emitter fiber.

E39-F3C

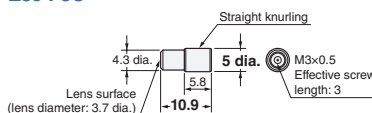

Material: Aluminum for body and optical glass for lens.
Note: This is the Lens Unit for the E32-C31 and E32-C31N.

25-D E32-C21N 2M (Free Cutting) + E39-F3C

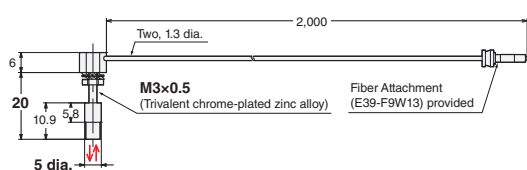

Note: There is a white line on the emitter fiber.

25-E E32-C42S 1M (No Cutting)

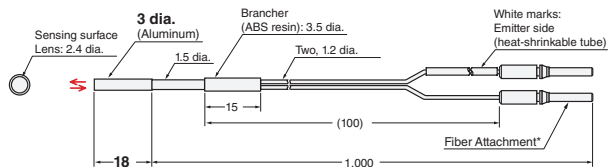

* Attached with adhesive and cannot be removed.
Note: There is a white tube on the emitter fiber.

25-F E32-L15 2M (Free Cutting)

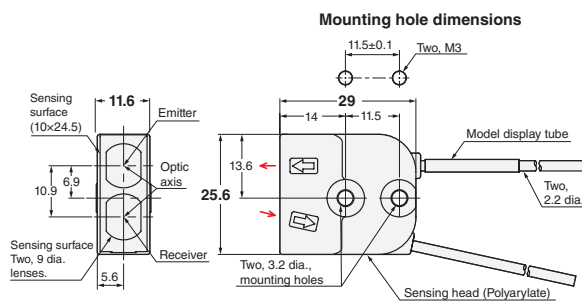

Note: There is a white tube on the emitter fiber.

- Reference Information for Model Selection -

Model Selection Tips

Select the best model by following these steps.

- Select the model based on the spot diameter suitable for the workpiece size.
 * The Variable-spot Type is useful if there are different sensing object sizes.
- Select the model based on the allowable installation distance and center distance.

<Map of Spot Diameters and Center Distances>

(Unit: mm)

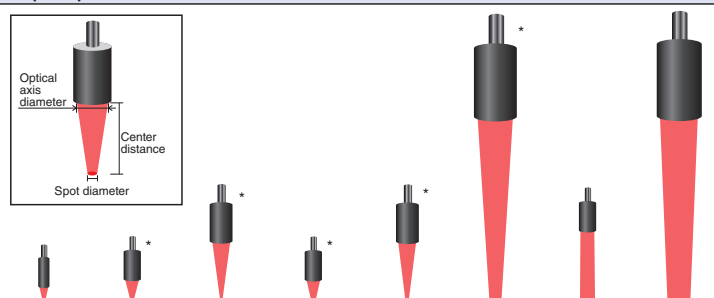

Spot diameter	0.1 dia.	0.1 dia.	0.2 dia.	0.5 dia.	0.5 dia.	3 dia.	4 dia.	6 dia.
Center distance	5	7	17	7	17	50	0 to 20	50
Optical axis diameter	2.4	3.7	4.8	3.7	4.8	9.4	3.7	10
Models	E32-C42S	E39-F3A-5 + E32-C41	E39-F3B + E32-C41	E39-F3A-5 + E32-C31 E32-C21N	E39-F3B + E32-C31 E32-C21N	E39-F18 + E32-CC200 E32-C91N	E39-F3C + E32-C31 E32-C21N	E32-L15

* Refer to page 26 for details.

Fiber Sensor Features

Selection Guide

Fiber Units

Threaded
Hex-shaped
Cylindrical

Standard Installation

Flat

Saving Space

Sleeved

Saving Space

Small Spot

Beam Improvements

High Power

Beam Improvements

Narrow view

Beam Improvements

BGS

Beam Improvements

Retro-reflective

Transparent Objects

Limited-reflective

Transparent Objects

Chemical-resistant, Oil-resistant

Environmental Immunity

Bending

Environmental Immunity

Heat-resistant

Environmental Immunity

Area Detection

Applications

Liquid-level

Applications

Vacuum

Applications

FPD, Semi, Solar

Applications

Installation Information

Fiber Amplifiers, Communications Unit, and Accessories

Technical Guide and Precautions

Model Index

- Threaded
- Hex-shaped
- Cylindrical

- Flat
- Sleeved

- Small Spot
- High Power
- Narrow view
- BGS

- Retro-reflective
- Limited-reflective

- Chemical-resistant, Oil-resistant
- Bending
- Heat-resistant

- Area Detection
- Liquid-level
- Vacuum
- FPD, Semi, Solar

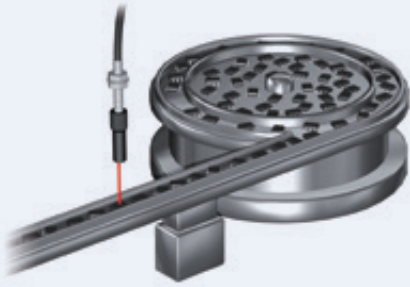

- Small-spot is ideal for detecting minute objects. Select the Fiber Unit that is best suited for the workpiece size and installation distance. (Refer to Reference Information for Model Selection)

Specifications

Reflective Fiber Units

Small-spot Models

Lens Units + Fiber Units

Type	Spot diameter	Center distance (mm)	Lens Units	Lens Units + Fiber Units	Fiber Units		27 Page Dimensions No.	
			Models	Appearance(mm)	Bending radius of cable	Models		
Short-distance, small-spot	0.1 dia.	7	E39-F3A-5		R25		E32-C41 1M	27-A
	0.5 dia.						E32-C31 2M	27-B
						Flexible, R2	E32-C21N 2M	27-C
Medium-distance, small-spot	0.2 dia.	17	E39-F3B		R25		E32-C41 1M	27-D
	0.5 dia.						E32-C31 2M	27-E
						Flexible, R2	E32-C21N 2M	27-F
Long-distance, small-spot	3 dia.	50	E39-F18		R25		E32-CC200 2M	27-G
					Flexible, R4	E32-C91N 2M	27-H	

* The spot diameter and the center distance are the same when using with E3X-ZV series or E3NX-FA□ series. The distance for E3NX-FAH□ infrared models varies.

Dimensions

Installation Information → 62 to 66 Page

Reflective Fiber Units

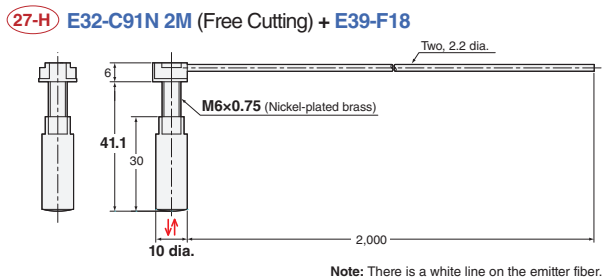
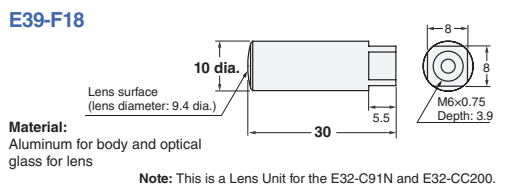
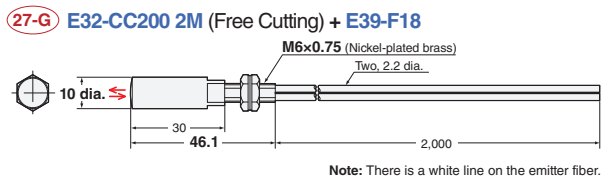
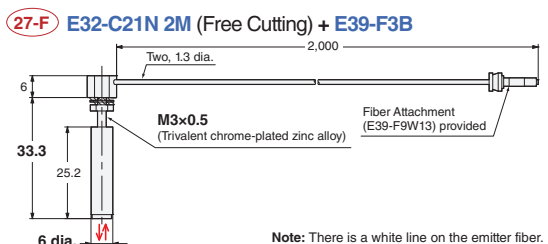
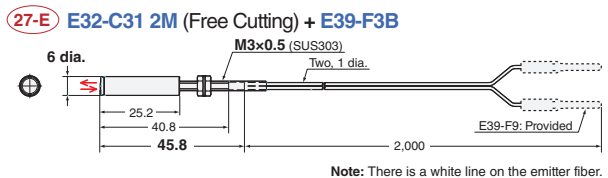
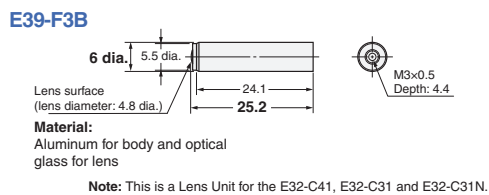
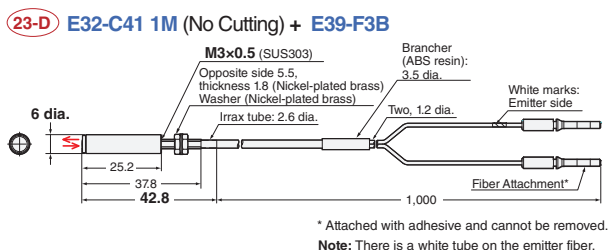
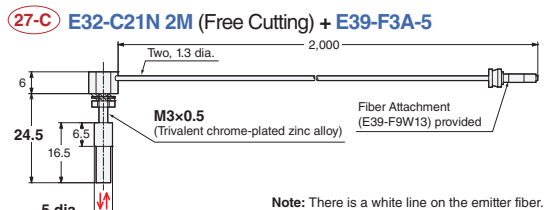
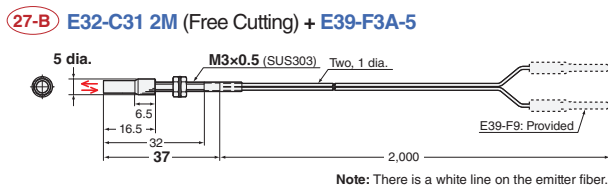
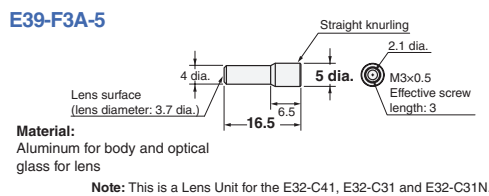
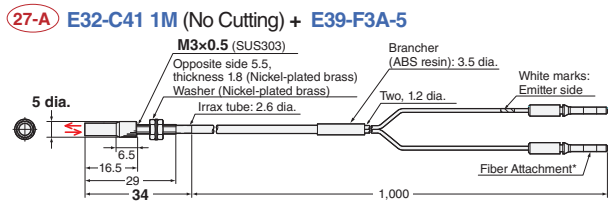

- Reference Information for Model Selection -

Model Selection Tips

- Select the best model by following these steps.
 - Select the model based on the spot diameter suitable for the workpiece size.
 - * The Variable-spot Type is useful if there are different sensing object sizes.
 - Select the model based on the allowable installation distance and center distance.

<Map of Spot Diameters and Center Distances>

(Unit: mm)

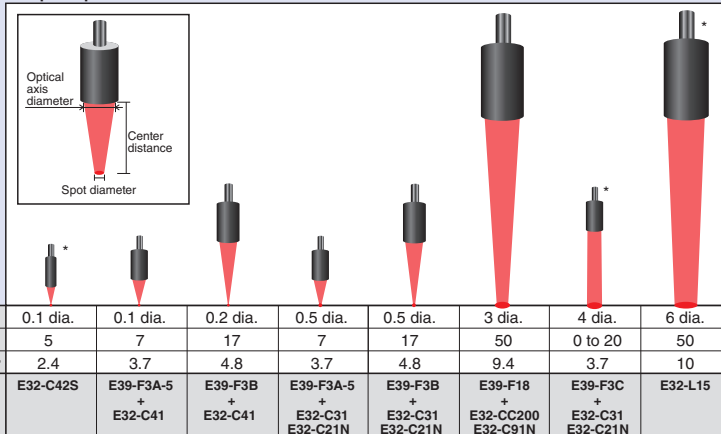

* Refer to page 24 for details.

Fiber Sensor Features

Selection Guide

Fiber Units

Threaded
Hex-shaped
Cylindrical

Standard Installation

Flat

Saving Space

Sleeved

Saving Space

Small Spot

Beam Improvements

High Power

Beam Improvements

Narrow view

Beam Improvements

BGS

Beam Improvements

Retro-reflective

Transparent Objects

Limited-reflective

Transparent Objects

Chemical-resistant, Oil-resistant

Environmental Immunity

Bending

Environmental Immunity

Heat-resistant

Environmental Immunity

Area Detection

Applications

Liquid-level

Applications

Vacuum

Applications

FPD, Semi, Solar

Applications

Installation Information

Fiber Amplifiers, Communications Unit, and Accessories

Technical Guide and Precautions

Model Index

- Threaded
- Hex-shaped
- Cylindrical

- Flat
- Sleeved

- Small Spot
- High Power
- Narrow view
- BGS

- Retro-reflective
- Limited-reflective

- Chemical-resistant, Oil-resistant
- Bending
- Heat-resistant

- Area Detection
- Liquid-level
- Vacuum
- FPD, Semi, Solar

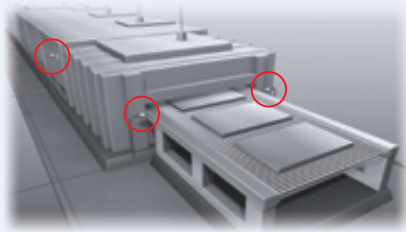

- Maximum sensing distance without attaching a Lens: 20 m (E32-T17L)
Suitable for detection of large objects and for use in large-scale installations.
- Powerful enough to resist the influences of dust and dirt.
(Refer to the comparisons of incident level on the Reference Information for Model Selection.)
- In addition to the products listed on this page, Lenses are available to extend the sensing distance. (→ 30 to 33 pages)

Specifications

Through-beam Fiber Units

Sensing direction	Aperture angle	Appearance (mm)	Bending radius of cable	Sensing distance (mm)				Optical axis diameter (minimum sensing object)	Models	29 Page Dimensions No.
				E3X-ZV		E3NX-FA				
				GIGA = HS	Other modes	GIGA = HS	Other modes			
Right-angle	15°		Flexible, R2	4,000 *1	ST : 3,500	4,000 *1	ST : 4,000	2.3 dia. (0.1 dia./0.03 dia.)	E32-LT11N 2M	29-A
				2,300	SHS: 920	3,450	SHS: 920			
Top-view	10°		R25	20,000 *2	ST : 20,000	20,000 *2	ST : 20,000	10 dia.	E32-T17L 10M	29-B
				20,000 *2	SHS: 8,000	20,000 *2	SHS: 8,000			
	15°		Flexible, R1	4,000 *1	ST : 4,000	4,000 *1	ST : 4,000	2.3 dia. (0.1 dia./0.03 dia.)	E32-LT11 2M	29-C
				2,700	SHS: 1,080	4,000 *1	SHS: 1,080			
Side-view	30°		R25	4,000 *1	ST : 4,000	4,000 *1	ST : 4,000	4 dia. (0.1 dia./0.03 dia.)	E32-T14 2M	29-D
				4,000 *1	SHS: 1,800	4,000 *1	SHS: 1,800			

*1 The optical fiber is 2 m long on each side, so the sensing distance is 4,000 mm.

*2 The optical fiber is 10 m long on each side, so the sensing distance is 20,000 mm.

Note1. The sensing distances for the E3NX-FA are values for E3NX-FA□ infrared models varies.

2. The E3X-HD Series offers the same sensing distance as the E3X-ZV.

Reflective Fiber Units

Sensing direction	Aperture angle	Appearance (mm)	Bending radius of cable	Sensing distance (mm)				Optical axis diameter (minimum sensing object)	Model	29 Page Dimensions No.
				E3X-ZV		E3NX-FA				
				GIGA = HS	Other modes	GIGA = HS	Other modes			
Top-view	4°		Bendresistant, R4	40 to 2,800	ST : 40 to 1,400	40 to 4,200	ST : 40 to 2,100	-	E32-D16 2M	29-E
				40 to 900	SHS: 40 to 480	40 to 1,350	SHS: 40 to 720			

Note 1. The following mode names and response times apply to the modes given in the Sensing distance column.

[E3X-ZV] GIGA: Giga-power mode (16 ms), HS: High-speed mode (250 μs), ST: Standard mode (1 ms), and SHS: Super-high-speed mode (50 μs)

[E3NX-FA] GIGA: Giga-power mode (16 ms), HS: High-speed mode (250 μs), ST: Standard mode (1 ms), and SHS: Super-high-speed mode (30 μs)

2. The values for the minimum sensing object are reference values that indicate values obtained in standard mode with the sensing distance and sensitivity set to the optimum values.

The first value is for the E3X-ZV and the second value is for the E3NX-FA.

3. The sensing distances for Reflective Fiber Units are for white paper.

4. The sensing distances for the E3NX-FA are values for E3NX-FA□ devices. The distance for E3NX-FA□ infrared models varies.

5. The E3X-HD Series offers the same sensing distance as the E3X-ZV.

Dimensions

Installation Information → 62 to 66 Page

Through-beam Fiber Units (Set of 2)

29-A E32-LT11N 2M (Free Cutting)

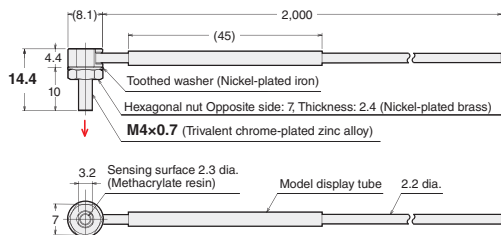

29-C E32-LT11 2M (Free Cutting)
E32-LT11R 2M (Free Cutting)

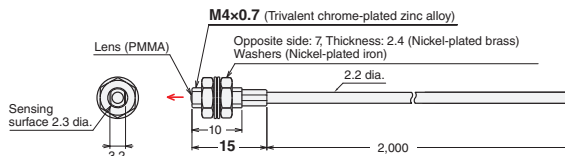

29-B E32-T17L 10M (Free Cutting)

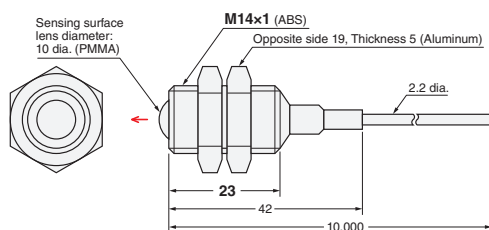

29-D E32-T14 2M (Free Cutting)

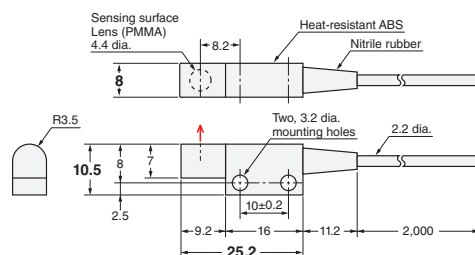

Installation Information → 62 to 66 Page

Reflective Fiber Units

29-E E32-D16 2M (Free Cutting)

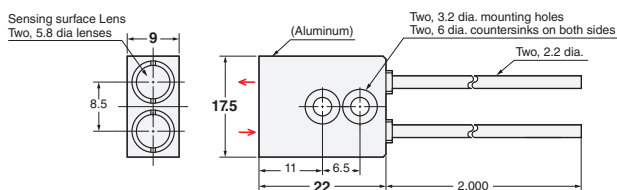

- Reference Information for Model Selection -

Comparisons of incident level

Select the model based on the comparisons of incident level against Standard Fiber Units.

Comparisons of incident level (Through-beam)

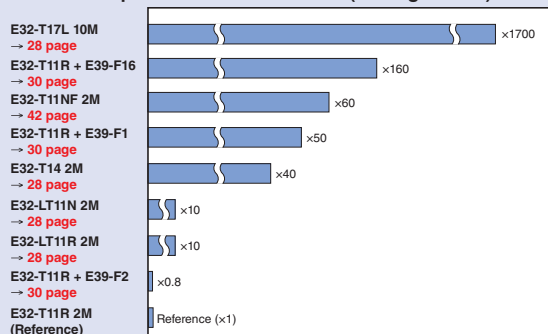

Comparisons of incident level (Reflective)

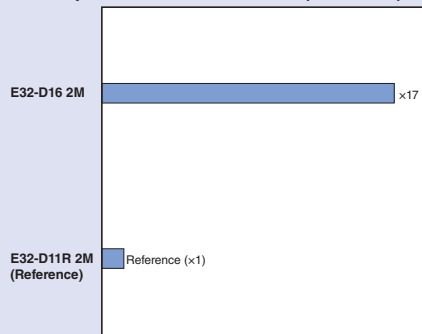

Fiber Sensor Features

Selection Guide

Fiber Units

Threaded
Hex-shaped
Cylindrical

Standard Installation

Flat
Sleeved

Saving Space

Small Spot
High Power

Beam Improvements

Narrow view
BGS

Retro-reflective
Limited-reflective

Transparent Objects

Chemical-resistant, Oil-resistant
Bending
Heat-resistant

Environmental Immunity

Area Detection
Liquid-level
Vacuum

Applications

FPD, Semi, Solar

Installation Information

Fiber Amplifiers, Communications Unit, and Accessories

Technical Guide and Precautions

Model Index

Specifications

Through-beam Fiber Units

Lens Units	Type	High-power (incident level: 50 times)	Ultra-high-power (incident level: 160 times)	Side-View (incident level: 0.8 times)										
	Models	E39-F1	E39-F16	E39-F2										
	Appearance													
	Aperture angle	Approx. 12°	Approx. 6°	Approx. 60°										
	Optical axis diameter (minimum sensing object)	4 dia. (0.1 dia.)	7.2 dia.	3 dia. (0.1 dia.)										
Fiber Units	Models	Appearance (mm)	Sensing distance (mm)											
			E3X-ZV		E3NX-FA		E3X-ZV		E3NX-FA		E3X-ZV		E3NX-FA	
			GIGA=HS	Other modes	GIGA=HS	Other modes	GIGA=HS	Other modes	GIGA=HS	Other modes	GIGA=HS	Other modes	GIGA=HS	Other modes
E32-T11N 2M		4,000* 4,000*	ST : 4,000 SHS: 2,000 31-A	4,000* 4,000*	ST : 4,000 SHS: 2,000	4,000* 4,000*	ST : 4,000 SHS: 3,600 31-D	4,000* 4,000*	ST : 4,000 SHS: 3,600	-	-	-	-	
E32-T11R 2M		4,000* 4,000*	ST : 4,000 SHS: 2,000 31-B	4,000* 4,000*	ST : 4,000 SHS: 2,000	4,000* 4,000*	ST : 4,000 SHS: 3,600 31-E	4,000* 4,000*	ST : 4,000 SHS: 3,600	1,450 500	ST : 800 SHS: 200 31-G	2,170 750	ST : 1,200 SHS: 200	
E32-T11 2M		4,000* 4,000*	ST : 4,000 SHS: 1,860 31-C	4,000* 4,000*	ST : 4,000 SHS: 1,860	4,000* 4,000*	ST : 4,000 SHS: 4,000 31-F	4,000* 4,000*	ST : 4,000 SHS: 4,000	2,300 860	ST : 1,320 SHS: 320 31-H	3,450 1,290	ST : 1,980 SHS: 320	

* The optical fiber is 2 m long on each side, so the sensing distance is 4,000 mm.

Note 1. The following mode names and response times apply to the modes given in the Sensing distance column.

[E3X-ZV] GIGA: Giga-power mode (16 ms), HS: High-speed mode (250 μs), ST: Standard mode (1 ms), and SHS: Super-high-speed mode (50 μs)
 [E3NX-FA] GIGA: Giga-power mode (16 ms), HS: High-speed mode (250 μs), ST: Standard mode (1 ms), and SHS: Super-high-speed mode (30 μs)

- The values for the minimum sensing object are reference values that indicate values obtained in standard mode with the sensing distance and sensitivity set to the optimum values. The first value is for the E3X-ZV and the second value is for the E3NX-FA.
- The sensing distances for the E3NX-FA are values for E3NX-FA□ devices. The distance for E3NX-FAH□ infrared models varies.
- The E3X-HD Series offers the same sensing distance as the E3X-ZV.

Dimensions

Installation Information → 62 to 66 Page

Lens Units (Set of 2)

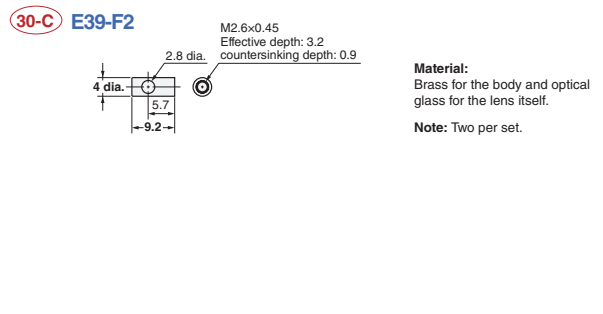
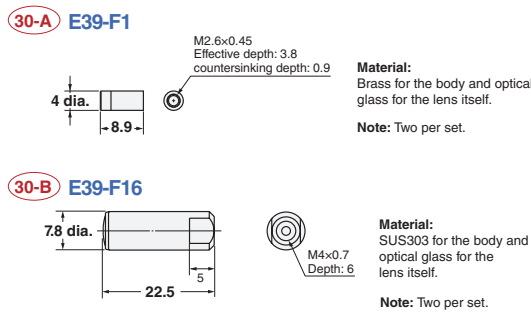

- Fiber Sensor Features
- Selection Guide
- Fiber Units
- Standard Installation
 - Threaded
 - Hex-shaped
 - Cylindrical
- Saving Space
 - Flat
 - Sleeved
- Beam Improvements
 - Small Spot
 - High Power
 - Narrow view
 - BGS
- Transparent Objects
 - Retro-reflective
 - Limited-reflective
- Environmental Immunity
 - Chemical-resistant, Oil-resistant
 - Bending
 - Heat-resistant
- Applications
 - Area Detection
 - Liquid-level
 - Vacuum
 - FPD, Semi, Solar
- Installation Information
- Fiber Amplifiers, Communications Unit, and Accessories
- Technical Guide and Precautions
- Model Index

Dimensions

Installation Information → 62 to 66 Page

Through-beam Fiber Units (Set of 2)

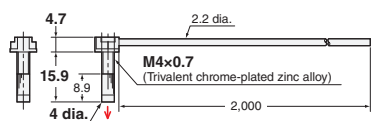
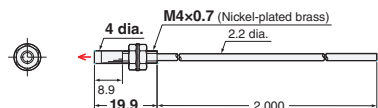
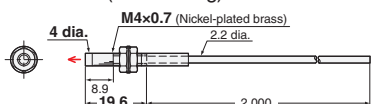
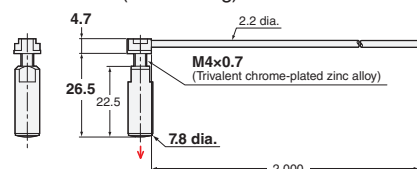
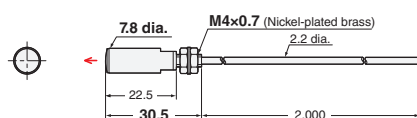
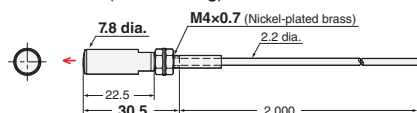
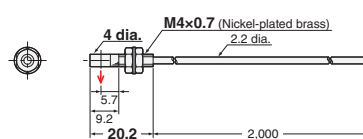
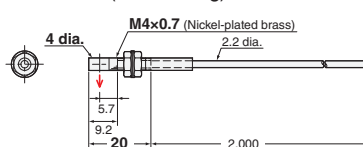
31-A E32-T11N 2M (Free Cutting) + E39-F1

31-B E32-T11R 2M (Free Cutting) + E39-F1

31-C E32-T11 2M (Free Cutting) + E39-F1

31-D E32-T11N 2M (Free Cutting) + E39-F16

31-E E32-T11R 2M (Free Cutting) + E39-F16

31-F E32-T11 2M (Free Cutting) + E39-F16

31-G E32-T11R 2M (Free Cutting) + E39-F2

31-H E32-T11 2M (Free Cutting) + E39-F2

Fiber Sensor Features

Selection Guide

Fiber Units

 Threaded
Hex-shaped
Cylindrical

 Flat
Sleeved

 Small Spot
High Power

 Narrow view
BGS

 Retro-reflective
Limited-reflective

 Chemical-resistant, Oil-resistant
Bending

Heat-resistant

 Area Detection
Liquid-level
Vacuum

 FPD, Semi, Solar
Installation Information

Fiber Amplifiers, Communications Unit, and Accessories

Technical Guide and Precautions

Model Index

- Reference Information for Model Selection -

Comparisons of incident level

Select the model based on the comparisons of incident level against Standard Fiber Units.

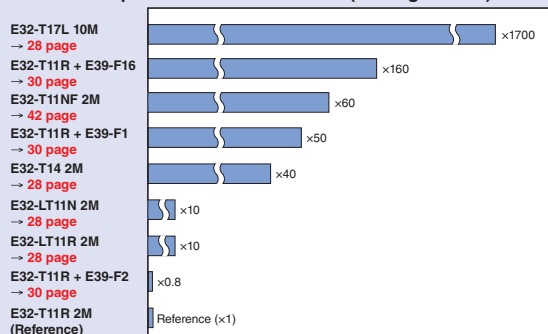
Comparisons of incident level (Through-beam)

Specifications

Through-beam Fiber Units (Heat-resistant)

Lens Units	Type	High-power (incident level: 50 times)	Ultra-high-power (incident level: 160 times)	Side-View (incident level: 0.8 times)					
	Models	E39-F1	E39-F16	E39-F2					
	Appearance								
	Aperture angle	Approx. 12°	Approx. 6°	Approx. 60°					
	Optical axis diameter (minimum sensing object)	4 dia. (0.1 dia.)	7.2 dia.	3 dia. (0.1 dia.)					
Fiber Units		Sensing distance (mm)							
Models	Appearance (mm)	E3X-ZV		E3NX-FA		E3X-ZV		E3NX-FA	
		GIGA=HS	Other modes	GIGA=HS	Other modes	GIGA=HS	Other modes	GIGA=HS	Other modes
E32-T51R 2M	Heat-resistant up to 100°C 	4,000*	ST : 4,000*	4,000*	ST : 4,000*	4,000*	ST : 4,000*	4,000*	ST : 4,000*
		3,900	SHS: 1,500	4,000*	SHS: 1,500	4,000*	SHS: 4,000*	4,000*	SHS: 4,000*
E32-T81R-S 2M	Heat-resistant up to 200°C 	4,000*	ST : 4,000*	4,000*	ST : 4,000*	4,000*	ST : 4,000*	4,000*	ST : 4,000*
		2,700	SHS: 1,000	4,000*	SHS: 1,000	4,000*	SHS: 1,800	4,000*	SHS: 1,800
E32-T61-S 2M	Heat-resistant up to 350°C (200°C) (See Note 3) 	4,000*	ST : 4,000*	4,000*	ST : 4,000*	4,000*	ST : 4,000*	4,000*	ST : 4,000*
		4,000*	SHS: 1,800	4,000*	SHS: 1,800	4,000*	SHS: 3,100	4,000*	SHS: 3,100

* The optical fiber is 2 m long on each side, so the sensing distance is 4,000 mm.

Note 1. The following mode names and response times apply to the modes given in the Sensing distance column.

[E3X-ZV] GIGA: Giga-power mode (16 ms), HS: High-speed mode (250 μs), ST: Standard mode (1 ms), and SHS: Super-high-speed mode (50 μs)

[E3NX-FA] GIGA: Giga-power mode (16 ms), HS: High-speed mode (250 μs), ST: Standard mode (1 ms), and SHS: Super-high-speed mode (30 μs)

2. The values for the minimum sensing object are reference values that indicate values obtained in standard mode with the sensing distance and sensitivity set to the optimum values.

The first value is for the E3X-ZV and the second value is for the E3NX-FA.

3. The ambient temperature of E32-T61-S must be between -40 to 200°C when using it with E39-F1 or E39-F2 Lens Unit.

The ambient temperature of E32-T61-S must be between -40 to 350°C when using it with E39-F16 Lens Unit.

4. The sensing distances for the E3NX-FA are values for E3NX-FA□ devices. The distance for E3NX-FAH□ infrared models varies.

5. The E3X-HD Series offers the same sensing distance as the E3X-ZV.

Lens Units	Type	High-power (incident level: 50 times)	Ultra-high-power (incident level: 160 times)		
	Models	E39-F1-33	E39-F16		
	Appearance				
	Aperture angle	Approx. 12°	Approx. 6°		
	Optical axis diameter (minimum sensing object)	4 dia. (0.1 dia.)	7.2 dia.		
Fiber Units		Sensing distance (mm)			
Models	Appearance (mm)	E3X-ZV		E3NX-FA	
		GIGA=HS	Other modes	GIGA=HS	Other modes
E32-T51 2M	Heat-resistant up to 150°C 	4,000*	ST : 4,000*	4,000*	ST : 4,000*
		2,300	SHS: 1,400	3,450	SHS: 1,400

* The optical fiber is 2 m long on each side, so the sensing distance is 4,000 mm.

Note 1. The following mode names and response times apply to the modes given in the Sensing distance column.

[E3X-ZV] GIGA: Giga-power mode (16 ms), HS: High-speed mode (250 μs), ST: Standard mode (1 ms), and SHS: Super-high-speed mode (50 μs)

[E3NX-FA] GIGA: Giga-power mode (16 ms), HS: High-speed mode (250 μs), ST: Standard mode (1 ms), and SHS: Super-high-speed mode (30 μs)

2. The values for the minimum sensing object are reference values that indicate values obtained in standard mode with the sensing distance and sensitivity set to the optimum values.

The first value is for the E3X-ZV and the second value is for the E3NX-FA.

3. The sensing distances for the E3NX-FA are values for E3NX-FA□ devices. The distance for E3NX-FAH□ infrared models varies.

4. The E3X-HD Series offers the same sensing distance as the E3X-ZV.

Dimensions

Installation Information → 62 to 66 Page

Lens Units (Set of 2)

32-A E39-F1

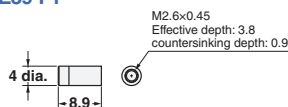

Material: Brass for the body and optical glass for the lens itself.

Note: Two per set.

32-C E39-F2

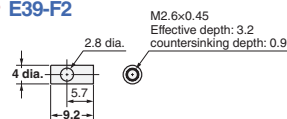

Material: Brass for the body and optical glass for the lens itself.

Note: Two per set.

32-B E39-F16

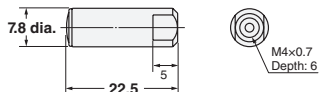

Material: SUS303 for the body and optical glass for the lens itself.

Note: Two per set.

32-D E39-F1-33

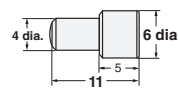

Material: Brass for the body and optical glass for the lens itself.

Note 1: Two per set.

Note 2: This is the Lens Unit for the E32-T51.

Fiber Sensor Features

Selection Guide

Fiber Units

Standard Installation

Saving Space

Beam Improvements

Transparent Objects

Environmental Immunity

Applications

Installation Information

Fiber Amplifiers, Communications Unit, and Accessories

Technical Guide and Precautions

Model Index

Dimensions

Installation Information → 62 to 66 Page

Through-beam Fiber Units (Set of 2)

33-A E32-T51R 2M (Free Cutting) + E39-F1

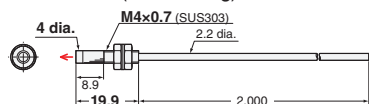

33-G E32-T51R 2M (Free Cutting) + E39-F2

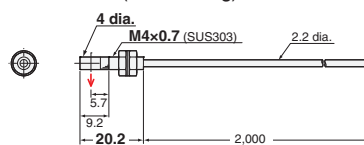

33-B E32-T81R-S 2M (No Cutting) + E39-F1

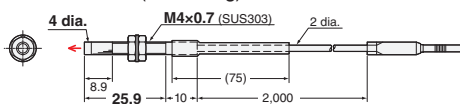

33-H E32-T81R-S 2M (No Cutting) + E39-F2

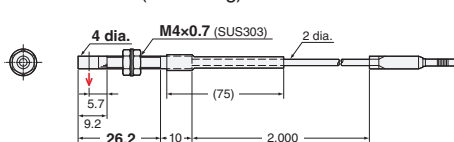

33-C E32-T61-S 2M (No Cutting) + E39-F1

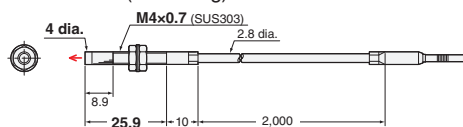

33-I E32-T61-S 2M (No Cutting) + E39-F2

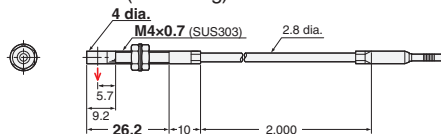

33-D E32-T51R 2M (Free Cutting) + E39-F16

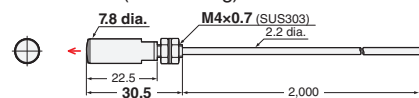

33-J E32-T51 2M (Free Cutting) + E39-F1-33

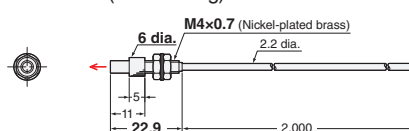

33-E E32-T81R-S 2M (No Cutting) + E39-F16

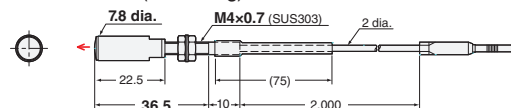

33-K E32-T51 2M (Free Cutting) + E39-F16

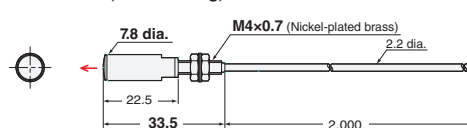

33-F E32-T61-S 2M (No Cutting) + E39-F16

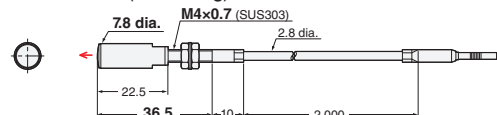

- Reference Information for Model Selection -

Comparisons of incident level

Select the model based on the comparisons of incident level against Standard Fiber Units.

Comparisons of incident level (Through-beam)

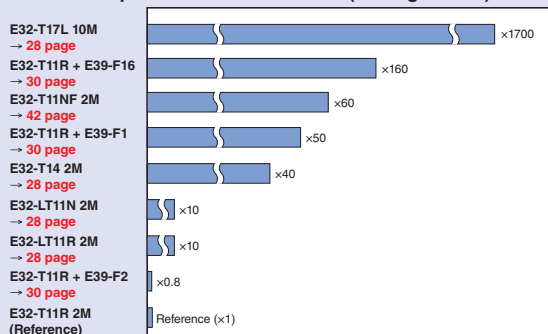

Fiber Sensor Features

Selection Guide

Fiber Units

Threaded
Hex-shaped
Cylindrical

Standard Installation

Flat
Sleeved

Saving Space

Small Spot

High Power

Beam Improvements

Narrow view

BGS

Retro-reflective

Transparent Objects

Limited-reflective

Chemical-resistant, Oil-resistant

Environmental Immunity

Bending

Heat-resistant

Area Detection

Liquid-level

Applications

Vacuum

FPD, Semi, Solar

Installation Information

Fiber Amplifiers, Communications Unit, and Accessories

Technical Guide and Precautions

Model Index

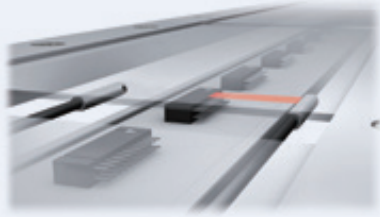

- The fine beam prevents false detection of light that is reflected off surrounding objects.

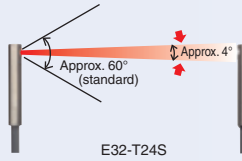

- Standard Installation
- Threaded
 - Hex-shaped
 - Cylindrical

- Saving Space
- Flat
 - Sleeved

- Beam Improvements
- Small Spot
 - High Power

- Beam Improvements
- Narrow view
 - BGS

- Transparent Objects
- Retro-reflective
 - Limited-reflective

- Environmental Immunity
- Chemical-resistant, Oil-resistant
 - Bending
 - Heat-resistant

- Applications
- Area Detection
 - Liquid-level
 - Vacuum
 - FPD, Semi, Solar

- Installation Information

- Fiber Amplifiers, Communications Unit, and Accessories

- Technical Guide and Precautions

- Model Index

Specifications

Through-beam Fiber Units

Sensing direction	Aperture angle	Appearance (mm)	Bending radius of cable	Sensing distance (mm)				Optical axis diameter (minimum sensing object)	Models	35 Page Dimensions No.
				E3X-ZV		E3NX-FA				
				GIGA = HS	Other modes	GIGA = HS	Other modes			
Side-view	1.5°		Flexible, R1	4,000*	ST : 1,780	4,000*	ST : 2,670	2 dia. (0.1 dia./ 0.03 dia.)	E32-A03 2M	35-A
				1,200	SHS: 500	1,800	SHS: 500			
	3.4°		R10	1,280	ST : 680	1,920	ST : 1,020	1.2 dia. (0.1 dia./ 0.03 dia.)	E32-A04 2M	35-C
				450	SHS: 200	670	SHS: 200			
Top-view	4°		Flexible, R1	4,000*	ST : 2,200	4,000*	ST : 3,300	2 dia. (0.1 dia./ 0.03 dia.)	E32-T24SR 2M	35-D
				1,460	SHS: 580	2,190	SHS: 580			
	3.4°		R10	4,000*	ST : 2,600	4,000*	ST : 3,900	1.7 dia. (0.1 dia./ 0.03 dia.)	E32-T24S 2M	35-E
				1,740	SHS: 700	2,610	SHS: 700			
1.5°		R10	4,000*	ST : 3,800	4,000*	ST : 4,000	1.7 dia. (0.1 dia./ 0.03 dia.)	E32-T22S 2M	35-F	
			2,500	SHS: 1,000	3,750	SHS: 1,000				

* The optical fiber is 2 m long on each side, so the sensing distance is 4,000 mm.

Note 1. The following mode names and response times apply to the modes given in the Sensing distance column.

[E3X-ZV] GIGA: Giga-power mode (16 ms), HS: High-speed mode (250 μs), ST: Standard mode (1 ms), and SHS: Super-high-speed mode (50 μs)

[E3NX-FA] GIGA: Giga-power mode (16 ms), HS: High-speed mode (250 μs), ST: Standard mode (1 ms), and SHS: Super-high-speed mode (30 μs)

2. The values for the minimum sensing object are reference values that indicate values obtained in standard mode with the sensing distance and sensitivity set to the optimum values.

The first value is for the E3X-ZV and the second value is for the E3NX-FA.

3. The sensing distances for the E3NX-FA are values for E3NX-FA□ devices. The distance for E3NX-FAH□ infrared models varies.

4. The E3X-HD Series offers the same sensing distance as the E3X-ZV.

Dimensions

Installation Information → 62 to 66 Page

Through-beam Fiber Units (Set of 2)

35-A E32-A03 2M (Free Cutting)

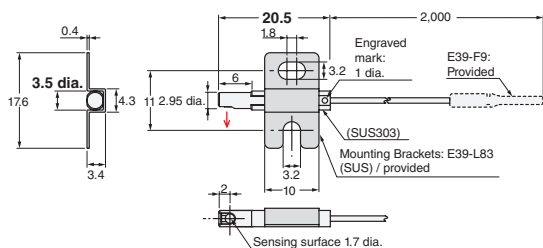

Note: Use the engraved surface and its opposing surface as installation (reference) surfaces.

35-B E32-A03-1 2M (Free Cutting)

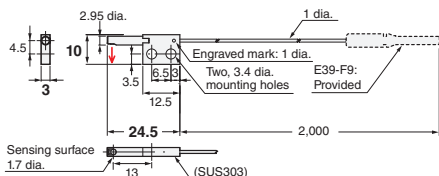

Note 1: Use the engraved surface and its opposing surface as installation (reference) surfaces.
Note 2: Set of two symmetrically shaped Fiber Units.

35-C E32-A04 2M (Free Cutting)

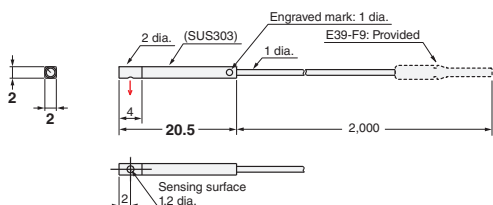

Note: Use the engraved surface and its opposing surface as installation (reference) surfaces.

35-D E32-T24SR 2M (Free Cutting)

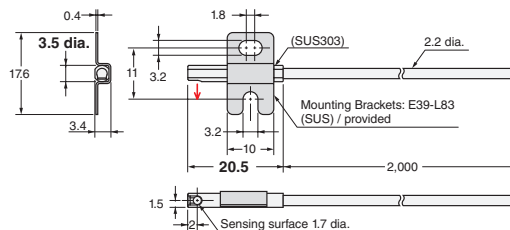

35-E E32-T24S 2M (Free Cutting)

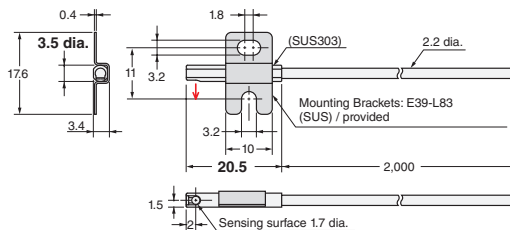

35-F E32-T22S 2M (Free Cutting)

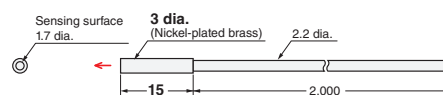

- Reference Information for Model Selection -

Aperture angle and Optical Axis Diameter

The Aperture angle is the output angle of the emitted beam, and the optical axis diameter is the core diameter of the emitter fiber. A fiber with a narrow view has a larger optical axis diameter than standard fibers, but the aperture angle is smaller so it is not influenced by surrounding objects.

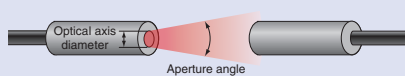

Fiber Sensor Features

Selection Guide

Fiber Units

Threaded
Hex-shaped
Cylindrical

Standard Installation

Flat
Sleeved

Saving Space

Small Spot
High Power

Narrow view

Beam Improvements

BGS

Retro-reflective
Limited-reflective

Transparent Objects

Chemical-resistant,
Oil-resistant

Environmental Immunity

Bending

Heat-resistant

Environmental Immunity

Area Detection

Liquid-level

Applications

Vacuum

FPD,
Semi,
Solar

Installation Information

Fiber Amplifiers,
Communications Unit, and
Accessories

Technical Guide and
Precautions

Model Index

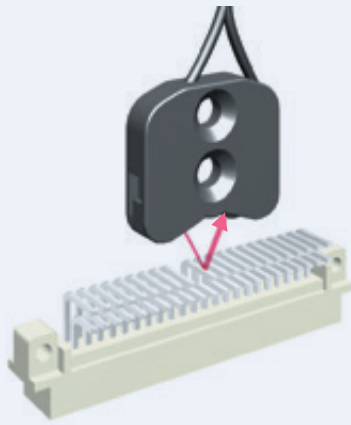

- These Fiber Units detect only objects in the sensing range. Objects in the background that are located beyond a certain point are not detected. They are not easily affected by the material or color of the sensing object.

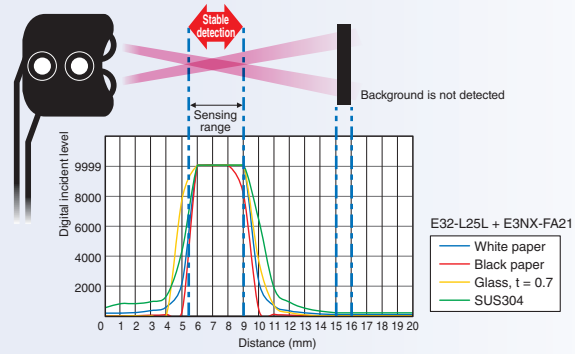

Specifications

Limited-reflective Fiber Units

Sensing direction	Appearance (mm)	Bending radius of cable	Sensing distance (mm)				Standard sensing object (minimum sensing object)	Models	37 Page Dimensions No.
			E3X-ZV		E3NX-FA				
			GIGA/HS	Other modes	GIGA/HS	Other modes			
Flat-view		R25	0 to 15 ST: 0 to 15 SHS: 0 to 12		0 to 15 ST: 0 to 15 SHS: 0 to 12		Soda glass with reflection factor of 7%	E32-L16-N 2M	37-A
		R10	0 to 4 ST: 0 to 4 SHS: 0 to 4		0 to 4 ST: 0 to 4 SHS: 0 to 4		(5 μm dia./ 2 μm dia.)	E32-L24S 2M	37-B
Side-view		R10	5.4 to 9 (Center 7.2) ST: 5.4 to 9 SHS: 5.4 to 9		5.4 to 9 (Center 7.2) ST: 5.4 to 9 SHS: 5.4 to 9			E32-L25L 2M	37-C

- Note 1.** If operation is affected by the background, perform power tuning or use the ECO Mode to decrease the incident light level.
- 2.** The following mode names and response times apply to the modes given in the Sensing distance column.
[E3X-ZV] GIGA: Giga-power mode (16 ms), HS: High-speed mode (250 μs), ST: Standard mode (1 ms), and SHS: Super-high-speed mode (50 μs)
[E3NX-FA] GIGA: Giga-power mode (16 ms), HS: High-speed mode (250 μs), ST: Standard mode (1 ms), and SHS: Super-high-speed mode (30 μs)
- 3.** The values for the minimum sensing object are reference values that indicate values obtained in standard mode with the sensing distance and sensitivity set to the optimum values.
The first value is for the E3X-ZV and the second value is for the E3NX-FA.
- 4.** The sensing distances for Reflective Fiber Units are for white paper.
- 5.** The sensing distances for the E3NX-FA are values for E3NX-FA□ devices. The distance for E3NX-FAH□ infrared models varies.
- 6.** The E3X-HD Series offers the same sensing distance as the E3X-ZV.

Dimensions

Installation Information → 62 to 66 Page

Limited-reflective Fiber Units

37-A E32-L16-N 2M (Free Cutting)

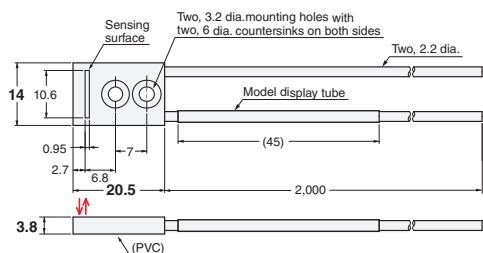

37-B E32-L24S 2M (Free Cutting)

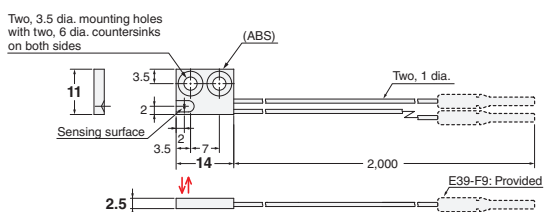

37-C E32-L25L 2M (Free Cutting)

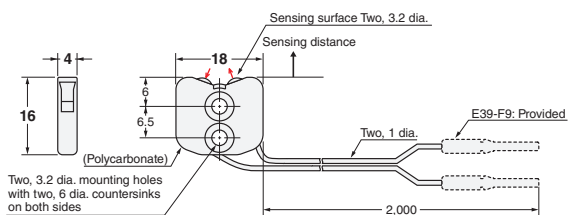

- Reference Information for Model Selection -

Sensing Distance vs. Digital Value

The following graphs show how the digital value is high within the sensing range and small outside. This explains why false detection does not occur outside the sensing range, even against common metal backgrounds, such as stainless steel.

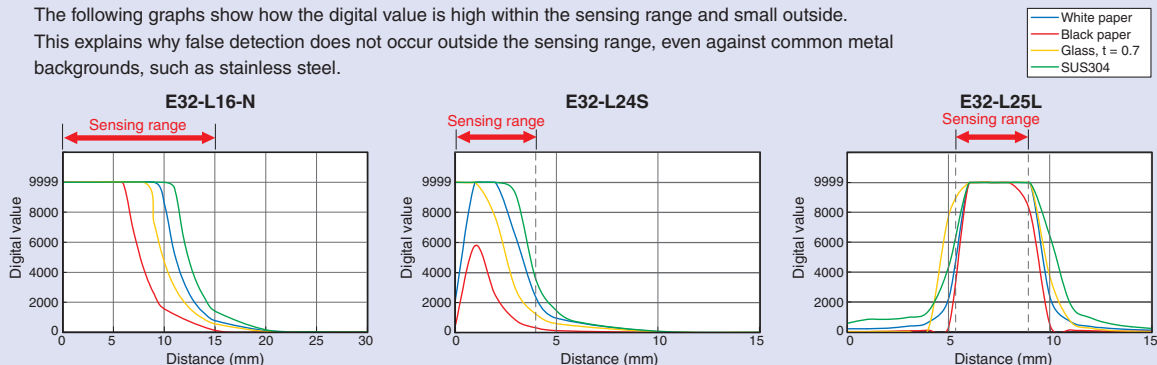

* E3NX-FA21 used in high-speed (HS) mode

Fiber Sensor Features

Selection Guide

Fiber Units

Threaded
Hex-shaped
Cylindrical

Standard Installation

Flat
Sleeved

Saving Space

Small Spot
High Power

Beam Improvements

Narrow view
BGS

Transparent Objects

Retro-reflective
Limited-reflective

Chemical-resistant, Oil-resistant

Bending
Heat-resistant

Environmental Immunity

Area Detection
Liquid-level

Applications

Vacuum
FPD, Semi, Solar

Installation Information

Installation Information

Fiber Amplifiers, Communications Unit, and Accessories

Technical Guide and Precautions

Model Index

- Threaded
- Hex-shaped
- Cylindrical

- Flat
- Sleeved

- Small Spot
- High Power
- Narrow view
- BGS

- Retro-reflective
- Limited-reflective

- Chemical-resistant, Oil-resistant
- Bending
- Heat-resistant

- Area Detection
- Liquid-level
- Vacuum
- FPD, Semi, Solar

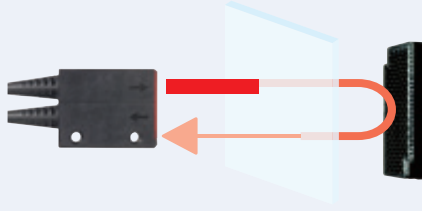

- Retro-reflective Fiber Units are ideal for detecting transparent objects. The light beam passes through the object twice, this model interrupts light more than Through-beam model.

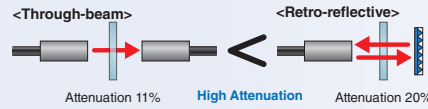

- Excellent detection performance with transparent films. (E32-LR11NP + E39-RP1)
The specially designed filter eliminates undesirable light, which allows significantly more light to be interrupted for stable detection of films.

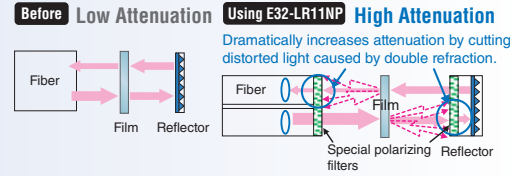
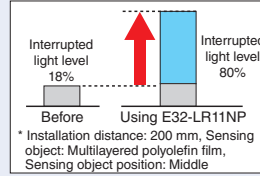

Specifications

Retro-reflective Fiber Units (With M.S.R. Function)

Type		Appearance (mm)	Bending radius of cable	Sensing distance (mm)				Optical axis diameter (minimum sensing object)	Models	39 Page Dimensions No.
Features	Size			E3X-ZV		E3NX-FA				
				GIGA HS	Other modes	GIGA HS	Other modes			
Film detection *	M6		Flexible, R2	1,350	ST : 1,200	2,020	ST : 1,800	-	E32-LR11NP 2M + E39-RP1	39-A
				1,000	SHS: 550	1,500	SHS: 550			
Square	—		R25	150 to 1,500	ST : 150 to 1,500	150 to 1,500	ST : 150 to 1,500	(0.2 dia./ 0.07 dia.)	E32-R16 2M	39-B
Threaded Models	M6		R10	10 to 250	ST : 10 to 250	10 to 370	ST : 10 to 370	(0.1 dia./ 0.03 dia.)	E32-R21 2M	39-C
				10 to 250	SHS: 10 to 250	10 to 370	SHS: 10 to 250			

* This effect may not be as strong for some films. Check suitability beforehand.

Note 1. Objects with a high reflection factor may cause the Fiber Sensor to detect reflected light as incident light. Also, stable detection may not be possible for transparent objects. Check suitability beforehand.

- The following mode names and response times apply to the modes given in the Sensing distance column.
[E3X-ZV] GIGA: Giga-power mode (16 ms), HS: High-speed mode (250 μs), ST: Standard mode (1 ms), and SHS: Super-high-speed mode (50 μs)
[E3NX-FA] GIGA: Giga-power mode (16 ms), HS: High-speed mode (250 μs), ST: Standard mode (1 ms), and SHS: Super-high-speed mode (30 μs)
- The values for the minimum sensing object are reference values that indicate values obtained in standard mode with the sensing distance and sensitivity set to the optimum values. The first value is for the E3X-ZV and the second value is for the E3NX-FA.
- The sensing distances for the E3NX-FA are values for E3NX-FA□ devices. The distance for E3NX-FAH□ infrared models varies.
- The E3X-HD Series offers the same sensing distance as the E3X-ZV.

Dimensions

Installation Information → 62 to 66 Page

Retro-reflective Fiber Units (With M.S.R. Function)

39-A E32-LR11NP 2M (Free Cutting)

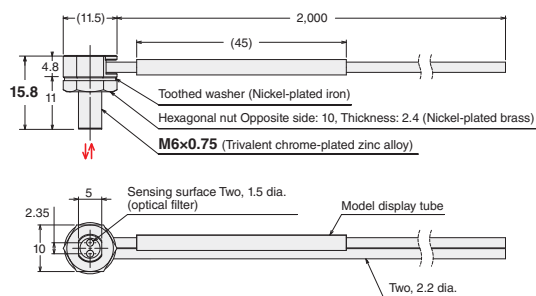

E39-RP1

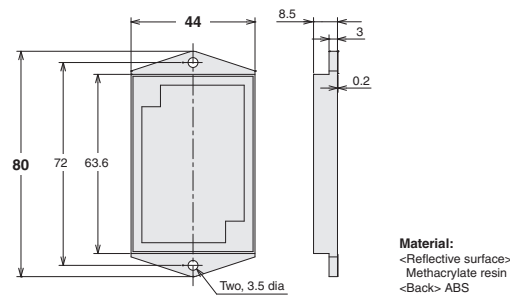

Material:
 <Reflective surface>
 Methacrylate resin
 <Back> ABS

39-B E32-R16 2M (Free Cutting)

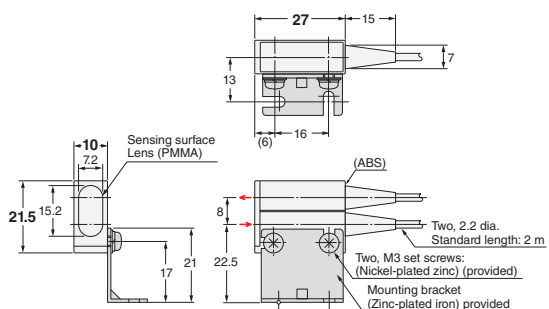

E39-R1 (Provided)

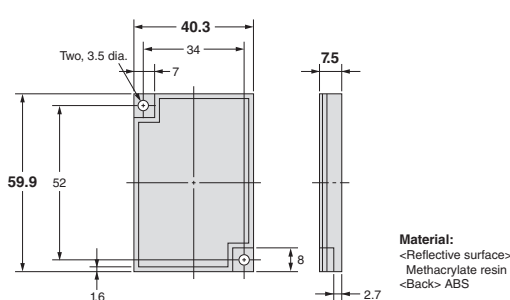

Material:
 <Reflective surface>
 Methacrylate resin
 <Back> ABS

39-C E32-R21 2M (Free Cutting)

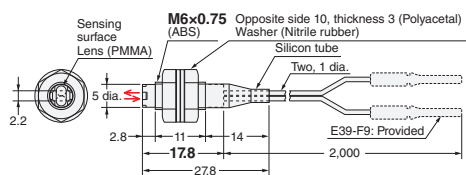

E39-R3 (Provided)

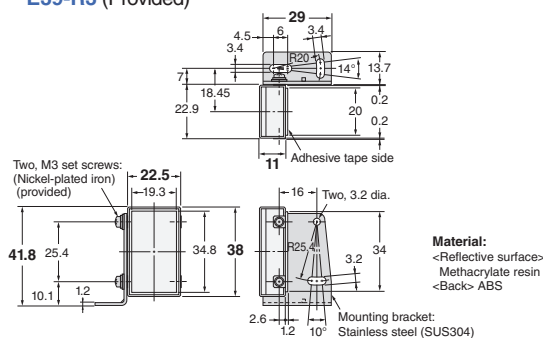

Material:
 <Reflective surface>
 Methacrylate resin
 <Back> ABS

- Reference Information for Model Selection -

Performance Comparison of Transparent Object Detection



For detecting transparent objects, consider using following products together: E32-LR11NP 2M + E39-RP1.

- This configuration features a special built-in optical filter that ensures stable detection of double-refractive materials, such as films and PET bottles.
- The retro-reflective model is suitable for detecting glass.

Sensing object	Film wrapper on cigarette packs	PET bottles	Glass bottles	Plate glass, t: 0.7
Models				
E32-LR11NP 2M + E39-RP1	○	○	○	○
E32-R16 2M	△	△	○	○
E32-R21 2M	△	△	○	○

E32-LR11NP Usage in Combination with a Sheet Reflector

Reference values of sensing distance are provided in the following table.

Reflector shape (mm)	Sensing distance (mm) (reference values)				Models
	E3X-ZV		E3NX-FA		
	GIGA	HS	GIGA	HS	
	550	ST : 500	820	ST : 750	E39-RSP1
	430	SHS: 250	640	SHS: 250	
	210	ST : 190	310	ST : 280	E39-RP37
	160	-	240	-	

Fiber Sensor Features

Selection Guide

Fiber Units

Threaded
Hex-shaped
Cylindrical

Standard Installation

Flat
Sleeved

Saving Space

Small Spot
High Power

Beam Improvements

Narrow view
BGS

Transparent Objects

Retro-reflective
Limited-reflective

Chemical-resistant, Oil-resistant
Bending

Environmental Immunity

Heat-resistant
Area Detection

Liquid-level
Vacuum

Applications

FPD, Semi, Solar
Installation Information

Fiber Amplifiers, Communications Unit, and Accessories

Technical Guide and Precautions

Model Index

- Threaded
- Hex-shaped
- Cylindrical

- Flat
- Sleeved

- Small Spot
- High Power
- Narrow view
- BGS

- Retro-reflective
- Limited-reflective

- Chemical-resistant, Oil-resistant
- Bending
- Heat-resistant

- Area Detection
- Liquid-level
- Vacuum
- FPD, Semi, Solar

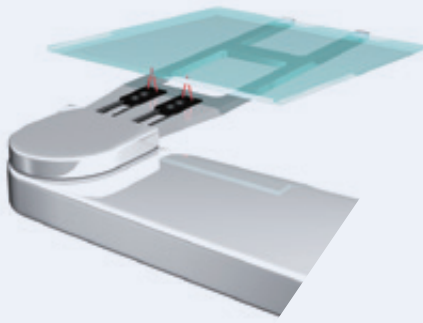

- These Fiber Units are based on a limited-reflective optical system where the emitting light and receiving light axes intersect at the same angle. This allows for stable detection of glass because the Fiber Units receives the specular reflection of the glass when the glass is in the sensing range.

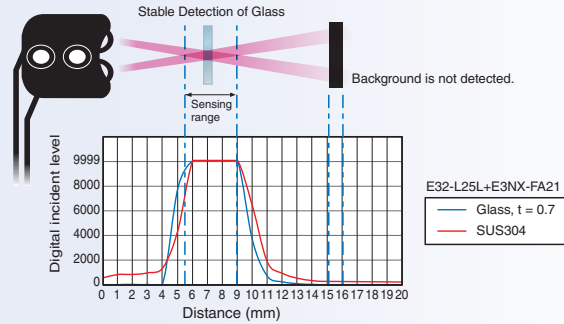

Specifications

Limited-reflective Fiber Units

Features	Type	Appearance (mm)	Bending radius of cable	Sensing distance (mm)				Standard sensing object (minimum sensing object)	Models	41 Page Dimensions No.
				E3X-ZV		E3NX-FA				
				GIGA	HS	GIGA	HS			
Small size	Flat-view		R10	0 to 4	ST : 0 to 4	0 to 4	ST : 0 to 4	(5 μm dia./ 2 μm dia.)	E32-L24S 2M	41-A
				0 to 4	SHS: 0 to 4	0 to 4	SHS: 0 to 4			
				0 to 15	ST : 0 to 15	0 to 15	ST : 0 to 15			
				0 to 15	SHS: 0 to 12	0 to 15	SHS: 0 to 12			
Standard	Flat-view		R25	10 to 20	ST : 10 to 20	10 to 20	ST : 10 to 20	Soda glass with reflection factor of 7%	E32-A08 2M	41-C
				10 to 20	SHS: -	10 to 20	SHS: -			
Standard long distance	Flat-view		R25	12 to 30	ST : 12 to 30	12 to 30	ST : 12 to 30	Soda glass with reflection factor of 7%	E32-A12 2M	41-D
				12 to 30	SHS: -	12 to 30	SHS: -			
Side View form	Side-view		R10	5.4 to 9	ST : 5.4 to 9 SHS: 5.4 to 9 (Center 7.2)	5.4 to 9	ST : 5.4 to 9 SHS: 5.4 to 9 (Center 7.2)	(5 μm dia./ 2 μm dia.)	E32-L25L 2M	41-E
Glass-substrate Mapping, 70°C	Top-view		R25	15 to 38 15 to 38 (Center 25)	ST : 15 to 38 (Center 25) SHS: -	15 to 38 15 to 38 (Center 25)	ST : 15 to 38 (Center 25) SHS: -	End surface of soda glass with reflection factor of 7% (t = 0.7 mm, rounded edges)	E32-A09 2M	41-F

* If operation is affected by the background, perform power tuning to decrease the incident light level.

Note 1. The following mode names and response times apply to the modes given in the Sensing distance column.

[E3X-ZV] GIGA: Giga-power mode (16 ms), HS: High-speed mode (250 μs), ST: Standard mode (1 ms), and SHS: Super-high-speed mode (50 μs)

[E3NX-FA] GIGA: Giga-power mode (16 ms), HS: High-speed mode (250 μs), ST: Standard mode (1 ms), and SHS: Super-high-speed mode (30 μs)

2. The values for the minimum sensing object are reference values that indicate values obtained in standard mode with the sensing distance and sensitivity set to the optimum values.

The first value is for the E3X-ZV and the second value is for the E3NX-FA.

3. The sensing distances for Reflective Fiber Units are for white paper.

4. The sensing distances for the E3NX-FA are values for E3NX-FA□ devices. The distance for E3NX-FA□ infrared models varies.

5. The E3X-HD Series offers the same sensing distance as the E3X-ZV.

Dimensions

Installation Information → 62 to 66 Page

Limited-reflective Fiber Units

(41-A) E32-L24S 2M (Free Cutting)

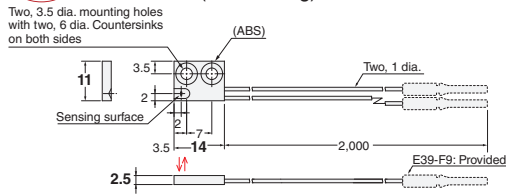

(41-B) E32-L16-N 2M (Free Cutting)

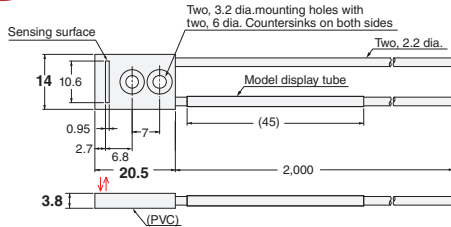

(41-C) E32-A08 2M (Free Cutting)

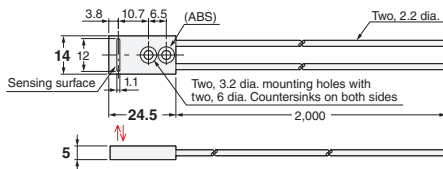

(41-D) E32-A12 2M (Free Cutting)

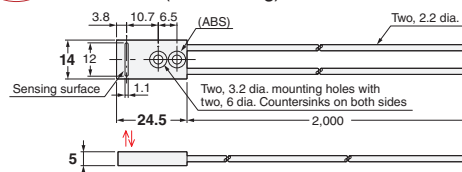

(41-E) E32-L25L 2M (Free Cutting)

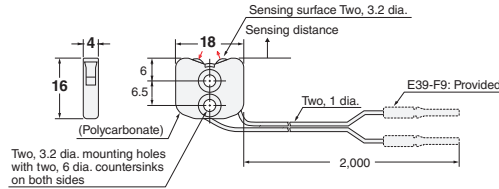

(41-F) E32-A09 2M (Free Cutting)

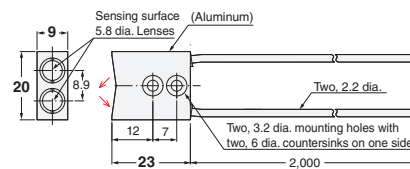

- Reference Information for Model Selection -

Sensing Distance vs. Digital Value

Limited-reflective Fiber Unit can keep high digital value within the sensing area for glass.
The digital value gets lower out of the sensing area for metals, including SUS (common as background).

— Glass, t = 0.7
— SUS304

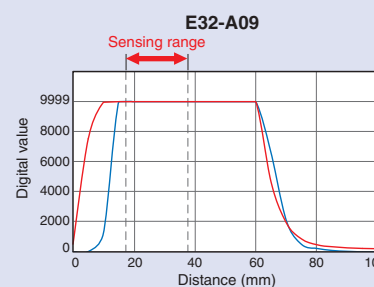
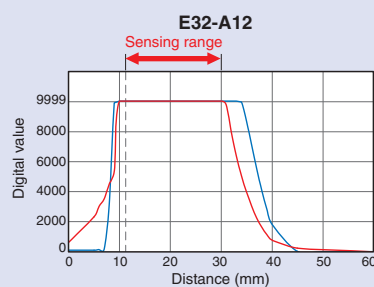
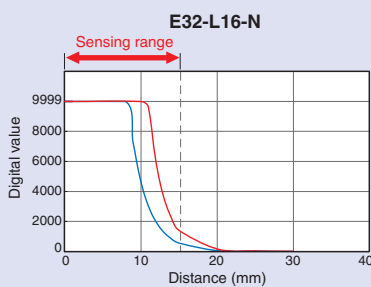
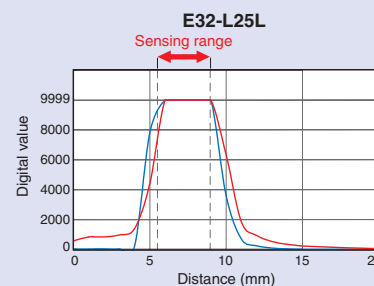
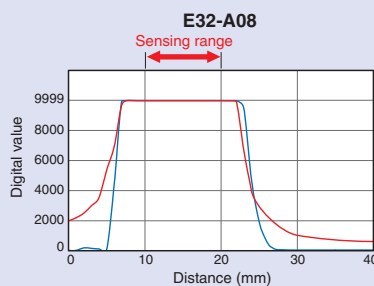
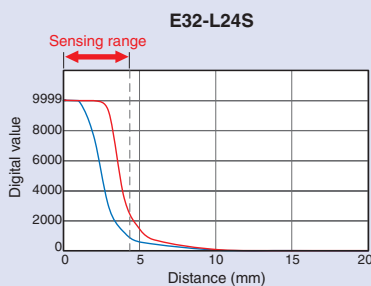

* E3NX-FA21 used in high-speed (HS) mode.

Fiber Sensor Features

Selection Guide

Fiber Units

Threaded	Standard Installation
Hex-shaped	
Cylindrical	
Flat	Saving Space
Sleeved	
Small Spot	Beam Improvements
High Power	
Narrow view	
BGS	

Retro-reflective	Transparent Objects
Limited-reflective	

Chemical-resistant, Oil-resistant	Environmental Immunity
Bending	
Heat-resistant	

Area Detection	Applications
Liquid-level	
Vacuum	
FPD, Semi, Solar	

Installation Information

Fiber Amplifiers, Communications Unit, and Accessories

Technical Guide and Precautions

Model Index

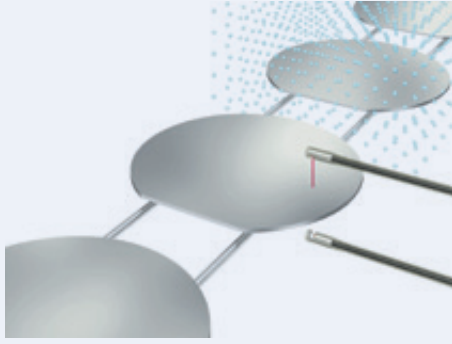

- These Fiber Units are made from fluororesin for resistance to chemicals.

Chemical-resistant Data for Fluororesin (Reference)

Chemical	Fluororesin	Acryl	ABS	Polycarbonate	Polyethylene	PVC
Hydrochloric acid	◎	△	△	△	△	×
Sulfuric acid	◎	×	×	×	×	×
Sodium hydroxide	◎	△	△	×	○	×
Methyl alcohol	◎	×	△	×	○	×
Acetone	◎	×	×	×	△	×
Toluene	◎	△	×	×	△	×
Benzene	◎	△	△	×	△	×

Note: Results depend on concentration.

Specifications

Through-beam Fiber Units

Type	Sensing direction	Appearance (mm)	Bending radius of cable	Sensing distance (mm)				Optical axis diameter (minimum sensing object)	Models	43 Page Dimensions No.
				E3X-ZV		E3NX-FA				
				GIGA	HS	Other modes	GIGA			
Oil-resistant	Right-angle		Flexible, R1	4,000 *1	*1	4,000 *1	*1	4 dia. (0.1 dia./0.03 dia.)	E32-T11NF 2M	43-A
			Flexible, R1	2,200	ST : 1,100	3,300	ST : 1,600	2 dia. (0.1 dia./0.03 dia.)	E32-T11NFS 2M	43-A2
Chemical/oil resistant	Top-view		R40	4,000 *1	*1	4,000 *1	*1	4 dia. (0.1 dia./0.03 dia.)	E32-T12F 2M	43-B
			R4	4,000 *1	*1	4,000 *1	*1		E32-T11F 2M	43-C
	Side-view		R40	1,400	ST : 800	2,100	ST : 1,200	3 dia. (0.1 dia./0.03 dia.)	E32-T14F 2M	43-D
Chemical/oil resistant 150°C *2	Top-view		R40	4,000 *1	*1	4,000 *1	*1	4 dia. (0.1 dia./0.03 dia.)	E32-T51F 2M	43-E

*1 The optical fiber is 2 m long on each side, so the sensing distance is 4,000 mm. *2 For continuous operation, use the Fiber Unit between -40 and 130°C.
 *3. The IP68G is the degree of protection which is defined according to the JIS (Japanese Industrial Standards). The IP68 indicates the same level of protection as defined by the IEC, and the G indicates that a device has resistance to oil. Passed OMRON's Oil-resistant Component Evaluation Standards (OMRON's own durability evaluation standards) (Cutting oil type: specified in JIS K 2241:2000; Temperature: 35°C max.)

Note1. The sensing distances for the E3NX-FA are values for E3NX-FA□ devices. The distance for E3NX-FAH□ infrared models varies.
 2. The E3X-HD Series offers the same sensing distance as the E3X-ZV.

Reflective Fiber Units

Type	Sensing direction	Appearance (mm)	Bending radius of cable	Sensing distance (mm)				Standard sensing object (minimum sensing object)	Models	43 Page Dimensions No.
				E3X-ZV		E3NX-FA				
				GIGA	HS	Other modes	GIGA			
Semiconductors: Cleaning, developing, and etching, 60°C	Top-view		R40	8 to 20 mm from tip of lens (Recommended sensing distance: 11 mm) 19 to 31 mm from center of mounting hole A (Recommended sensing distance: 22 mm)				Glass (t=0.7 mm)	E32-L11FP 2M	43-F
Semiconductors: Resist stripping, 85°C				8 to 20 mm from tip of lens (Recommended sensing distance: 11 mm) 32 to 44 mm from center of mounting hole A (Recommended sensing distance: 35 mm)					E32-L11FS 2M	43-G
Chemical/oil resistant				GIGA -	ST : 190	GIGA -	ST : 280	(5 μm dia./2 μm dia.)	E32-D12F 2M	43-H
Only cable: chemical resistant		R4	840	ST : 350	1,260	ST : 520	E32-D11U 2M		43-I	

Note 1. The following mode names and response times apply to the modes given in the Sensing distance column.
 [E3X-ZV] GIGA: Giga-power mode (16 ms), HS: High-speed mode (250 μs), ST: Standard mode (1 ms), and SHS: Super-high-speed mode (50 μs)
 [E3NX-FA] GIGA: Giga-power mode (16 ms), HS: High-speed mode (250 μs), ST: Standard mode (1 ms), and SHS: Super-high-speed mode (30 μs)
 2. The values for the minimum sensing object are reference values that indicate values obtained in standard mode with the sensing distance and sensitivity set to the optimum values. The first value is for the E3X-ZV and the second value is for the E3NX-FA. 3. The sensing distances for Reflective Fiber Units are for white paper.
 4. The sensing distances for the E3NX-FA are values for E3NX-FA□ devices. The distance for E3NX-FAH□ infrared models varies.
 5. The E3X-HD Series offers the same sensing distance as the E3X-ZV.

Dimensions

Installation Information → 62 to 66 Page

Installation Information → 62 to 66 Page

Through-beam Fiber Units (Set of 2)

Reflective Fiber Units

43-A E32-T11NF 2M (Free Cutting)

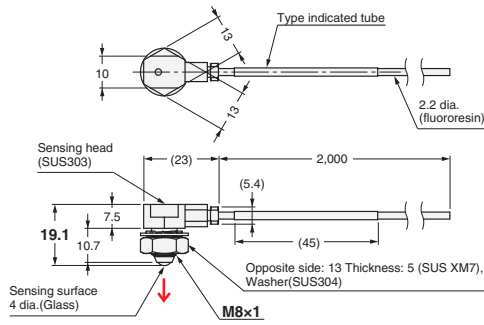

43-A2 E32-T11NFS 2M (Free Cutting)

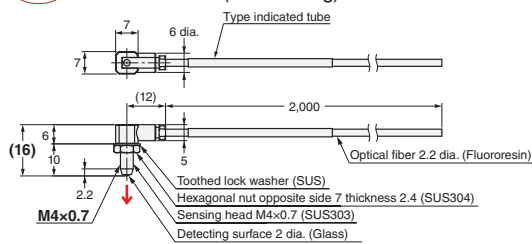

43-B E32-T12F 2M (Free Cutting)

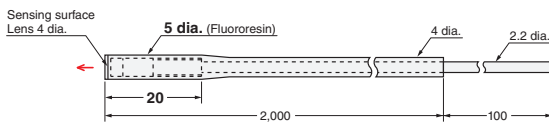

43-C E32-T11F 2M (Free Cutting)

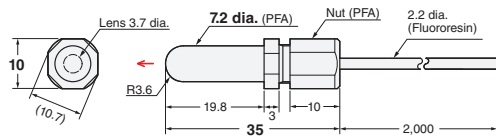

43-D E32-T14F 2M (Free Cutting)

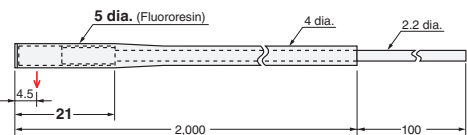

43-E E32-T51F 2M (Free Cutting)

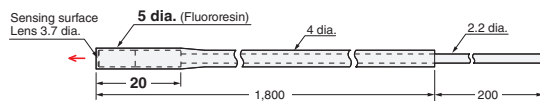

43-F E32-L11FP 2M (Free Cutting)

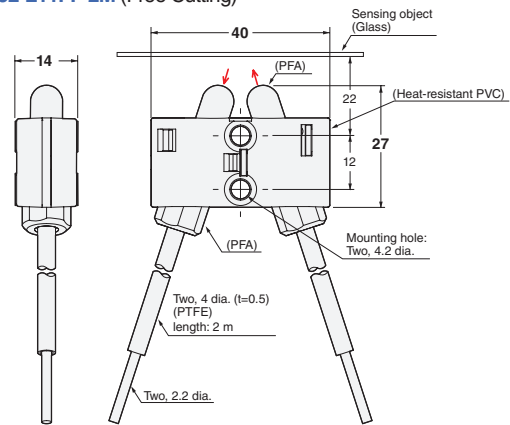

43-G E32-L11FS 2M (Free Cutting)

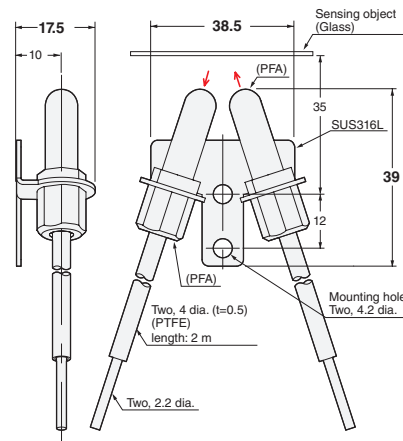

43-H E32-D12F 2M (Free Cutting)

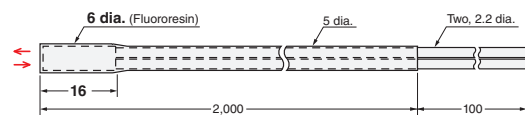

43-I E32-D11U 2M (Free Cutting)

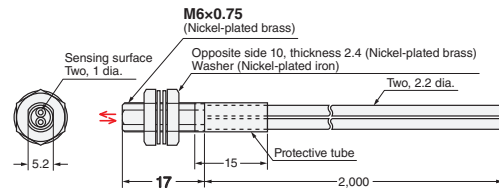

- Reference Information for Model Selection -

Oil-resistance performance of the E32-T11NF

Fluororesin Outer Cable Sheath

The fluororesin that covers the entire surface of the cable sheath (fiber covering) prevents the penetration of cutting oil.

Mechanical Seal Structure

An aluminum ring bushing is compressed and deformed by a set screw to seal the structure by pressing against the fluororesin part of the fiber core. This prevents the ingress of cutting oil from the joined surfaces.

Mechanical Seal Structure

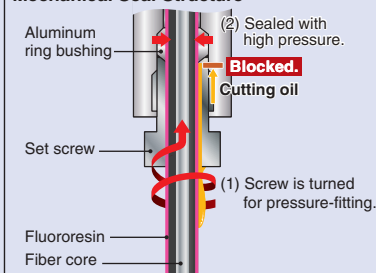

Structure Around Sensing Surface Also Resists Cutting Oil and Cutting Chips

Shape that prevents accumulation of oil drops and cutting chips

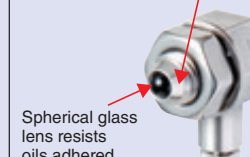

Fiber Sensor Features

Selection Guide

Fiber Units

Threaded
Hex-shaped
Cylindrical

Flat
Sleeved

Small Spot
High Power

Narrow view
BGS

Retro-reflective
Limited-reflective

Chemical-resistant, Oil-resistant
Bending
Heat-resistant

Area Detection
Liquid-level

Vacuum
FPD, Semi, Solar

Installation Information

Fiber Amplifiers, Communications Unit, and Accessories

Technical Guide and Precautions

Model Index

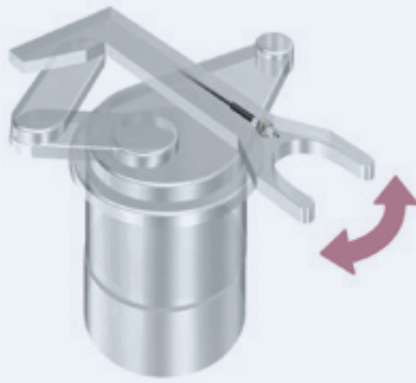

- Capable of withstanding one million repeated bends.

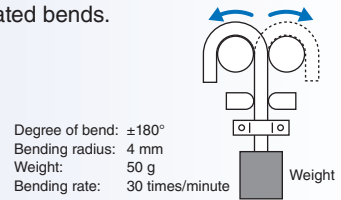

- A large number of independent fine fibers ensures good flexibility. Suitable for use on moving parts without easily breaking.



- Protective Stainless Spiral Tube is available for covering the fiber cable to protect it from accidental breaking due to snagging or shock.

Specifications

Through-beam Fiber Units

Size	Appearance (mm)	Bending radius of cable	Sensing distance (mm)				Optical axis diameter (minimum sensing object)	Models	45 Page Dimensions No.
			E3X-ZV		E3NX-FA				
			GIGA HS	Other modes	GIGA HS	Other modes			
1.5 dia.		Bendresistant, R4	680	ST : 400	1,020	ST : 600	0.5 dia. (5 μm dia./ 2 μm dia.)	E32-T22B 2M	45-A
M3			220	SHS: 90	330	SHS: 90		E32-T21 2M	45-B
M4			2,500	ST : 1,350	3,750	ST : 2,020	1 dia. (5 μm dia./ 2 μm dia.)	E32-T11 2M	45-C
Square			900	SHS: 360	1,350	SHS: 360			
			500	ST : 300	750	ST : 450	0.5 dia. (5 μm dia./ 2 μm dia.)	E32-T25XB 2M	45-D

- Note 1.** The following mode names and response times apply to the modes given in the Sensing distance column.
 [E3X-ZV] GIGA: Giga-power mode (16 ms), HS: High-speed mode (250 μs), ST: Standard mode (1 ms), and SHS: Super-high-speed mode (50 μs)
 [E3NX-FA] GIGA: Giga-power mode (16 ms), HS: High-speed mode (250 μs), ST: Standard mode (1 ms), and SHS: Super-high-speed mode (30 μs)
- The values for the minimum sensing object are reference values that indicate values obtained in standard mode with the sensing distance and sensitivity set to the optimum values. The first value is for the E3X-ZV and the second value is for the E3NX-FA.
 - The sensing distances for the E3NX-FA are values for E3NX-FA□ devices. The distance for E3NX-FA□ infrared models varies.
 - The E3X-HD Series offers the same sensing distance as the E3X-ZV.

Protective Stainless Spiral Tube (Sold separately)

Insert the fiber cable into the protective tube to prevent breaking by snagging or shock.

Applicable Fiber Units	Model	Quantity	45 Page Dimensions No.
E32-T11R 2M/E32-T11 2M/ E32-LT11 2M/E32-LT11R 2M/ E32-T51R 2M/E32-T51 2M	E39-F32C 1M	2 pieces	45-E

* This Tube cannot be used if a Lens Unit is being used.

Dimensions

Installation Information → 62 to 66 Page

Through-beam Fiber Units (Set of 2)

45-A E32-T22B 2M (Free Cutting)

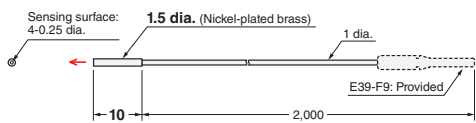

45-D E32-T25XB 2M (Free Cutting)

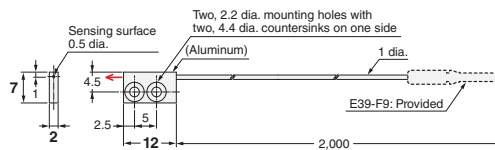

Note 1: Set of two symmetrically shaped Fiber Units.
Note 2: Four, M2 x 8 stainless steel countersunk mounting screws are provided.

45-B E32-T21 2M (Free Cutting)

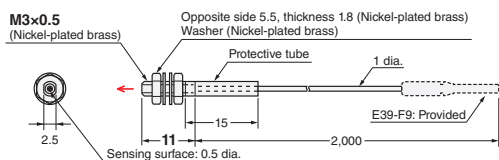

45-E E39-F32C 1M

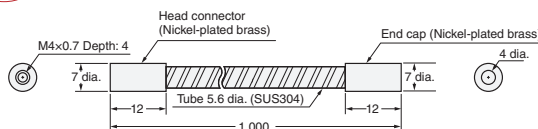

Note: Saddles (four, trivalent chromate-plated iron) are provided.

45-C E32-T11 2M (Free Cutting)

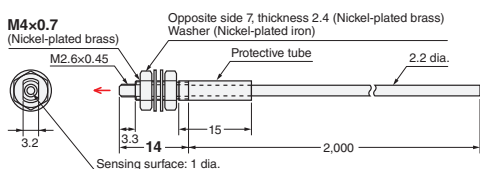

Fiber Sensor Features

Selection Guide

Fiber Units

Threaded
Hex-shaped
Cylindrical

Flat
Sleeved

Small Spot
High Power

Narrow view
BGS

Retro-reflective
Limited-reflective

Chemical-resistant, Oil-resistant
Bending
Heat-resistant

Area Detection
Liquid-level
Vacuum

FPD, Semi, Solar

Installation Information

Fiber Amplifiers, Communications Unit, and Accessories

Technical Guide and Precautions

Model Index

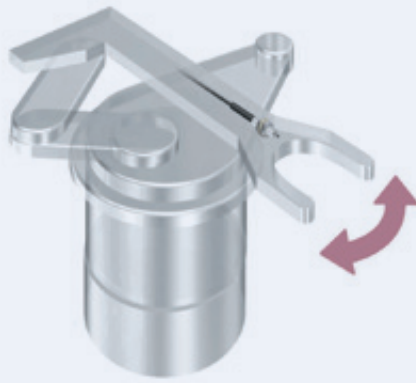

- Capable of withstanding one million repeated bends.

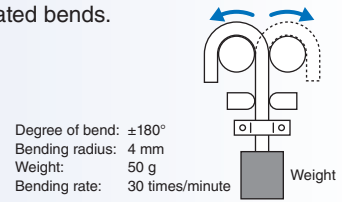

- A large number of independent fine fibers ensures good flexibility. Suitable for use on moving parts without easily breaking.



- Protective Stainless Spiral Tube is available for covering the fiber cable to protect it from accidental breaking due to snagging or shock.

Specifications

Reflective Fiber Units

Size	Appearance (mm)	Bending radius of cable	Sensing distance (mm)				Optical axis diameter (minimum sensing object)	Models	47 Page Dimensions No.
			E3X-ZV		E3NX-FA				
			GIGA	HS	Other modes	GIGA			
1.5 dia.		Bendresistant, R4	140		ST : 60	210	ST : 90	E32-D22B 2M	47-A
M3			40		SHS: 16	60	SHS: 16	E32-D21 2M	47-B
3 dia.			300		ST : 140	450	ST : 210	E32-D221B 2M	47-C
M4			90		SHS: 40	130	SHS: 40	E32-D21B 2M	47-D
M6			840		ST : 350	1,260	ST : 520	E32-D11 2M	47-E
Square			240		SHS: 100	360	SHS: 100	E32-D25XB 2M	47-F
			240		SHS: 30	90	SHS: 30		

Note 1. The following mode names and response times apply to the modes given in the Sensing distance column.
 [E3X-ZV] GIGA: Giga-power mode (16 ms), HS: High-speed mode (250 μs), ST: Standard mode (1 ms), and SHS: Super-high-speed mode (50 μs)
 [E3NX-FA] GIGA: Giga-power mode (16 ms), HS: High-speed mode (250 μs), ST: Standard mode (1 ms), and SHS: Super-high-speed mode (30 μs)
 2. The values for the minimum sensing object are reference values that indicate values obtained in standard mode with the sensing distance and sensitivity set to the optimum values.
 3. The first value is for the E3X-ZV and the second value is for the E3NX-FA. The sensing distances for Reflective Fiber Units are for white paper.
 4. The sensing distances for the E3NX-FA are values for E3NX-FA□ devices. The distance for E3NX-FAH□ infrared models varies.
 5. The E3X-HD Series offers the same sensing distance as the E3X-ZV.

Protective Stainless Spiral Tube (Sold separately)

Insert the fiber cable into the protective tube to prevent breaking by snagging or shock.

Applicable Fiber Units	Models	Quantity	47 Page Dimensions No.
E32-D21R 2M/E32-C31 2M/ E32-D21 2M	E39-F32A 1M	1 piece	47-G
E32-D211R 2M/E32-D21B 2M	E39-F32C 1M	2 pieces	
E32-D11R 2M/E32-CC200 2M/ E32-D11 2M/E32-D51R 2M/ E32-D51 2M	E39-F32D 1M	1 piece	

* This Tube cannot be used if a Lens Unit is being used.

Dimensions

Installation Information → 62 to 66 Page

Limited-reflective Fiber Units

47-A E32-D22B 2M (No Cutting)

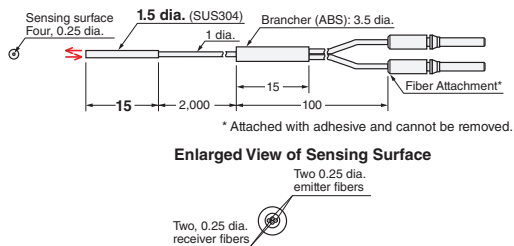

47-B E32-D21 2M (Free Cutting)

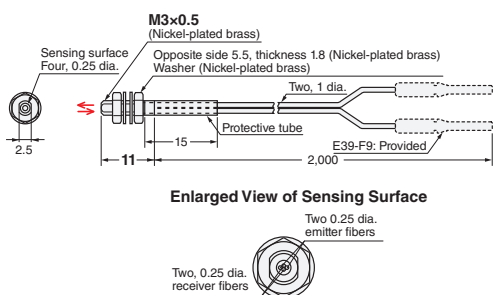

47-C E32-D221B 2M (Free Cutting)

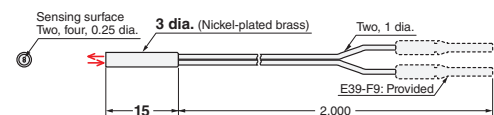

47-D E32-D21B 2M (Free Cutting)

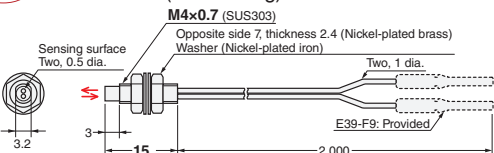

47-E E32-D11 2M (Free Cutting)

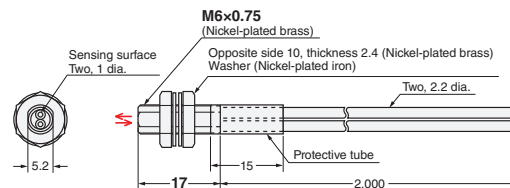

47-F E32-D25XB 2M (Free Cutting)

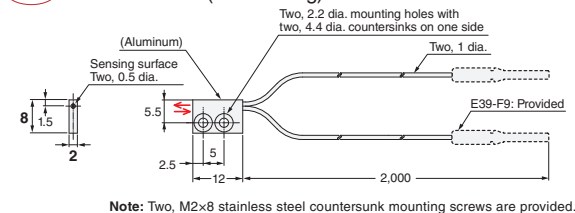

47-G E39-F32A 1M/E39-F32C 1M/E39-F32D 1M

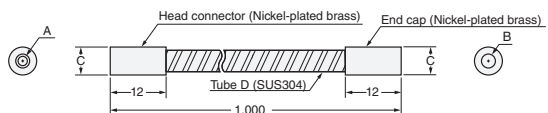

Models	A	B	C	D
E39-F32A 1M	M3x0.5 Depth: 4	3 dia.	6 dia.	(4.6 dia.)
E39-F32C 1M	M4x0.7 Depth: 4	4 dia.	7 dia.	(5.6 dia.)
E39-F32D 1M	M6x0.75 Depth: 4	5 dia.	8.5 dia.	(7 dia.)

Note: Saddles (two (four for the E39-F32C 1M), trivalent chromate-plated iron) are provided.

Fiber Sensor Features

Selection Guide

Fiber Units

Threaded
Hex-shaped
Cylindrical

Standard Installation

Flat
Sleeved

Saving Space

Small Spot
High Power

Beam Improvements

Narrow view
BGS

Retro-reflective
Limited-reflective

Transparent Objects

Chemical-resistant, Oil-resistant

Bending
Heat-resistant

Environmental Immunity

Area Detection
Liquid-level

Applications

Vacuum
FPD, Semi, Solar

Installation Information

Fiber Amplifiers, Communications Unit, and Accessories

Technical Guide and Precautions

Model Index

- Threaded
- Hex-shaped
- Cylindrical

- Flat
- Sleeved

- Small Spot
- High Power
- Narrow view
- BGS

- Retro-reflective
- Limited-reflective

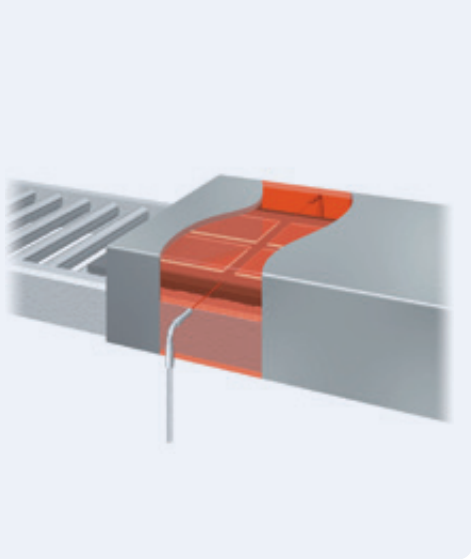

- Wide product variety for temperatures from 100 to 350°C. Select the model according to heat-resistant temperature.

Specifications

Through-beam Fiber Units

Heat-resistant temperature	Appearance (mm)	Bending radius of cable	Sensing distance (mm)				Optical axis diameter (minimum sensing object)	Models	49 Page Dimensions No.
			E3X-ZV		E3NX-FA				
			GIGA	HS	Other modes	GIGA			
100°C *1		Flexible, R2	1,600	ST : 800 SHS: 225	2,400	ST : 1,200 SHS: 225	1 dia. (0.1 dia./0.03 dia.)	E32-T51R 2M	49-A
150°C *2		R35	2,800	ST : 1,500 SHS: 400	4,000 *5	ST : 2,250 SHS: 400	1.5 dia. (0.1 dia./0.03 dia.)	E32-T51 2M	49-B
150°C *2		R35	840	ST : 450 SHS: 120	1,260	ST : 670 SHS: 120	1.5 dia. (0.1 dia./0.03 dia.)	E32-T54 2M	49-C
200°C *3		R10	1,000	ST : 550 SHS: 140	1,500	ST : 820 SHS: 140	0.7 dia. (5 µm dia./2 µm dia.)	E32-T61R-S 2M	49-D
200°C		R25	4,000 *5	ST : 2,600 SHS: 700	4,000 *5	ST : 3,900 SHS: 700	1.7 dia. (0.1 dia./0.03 dia.)	E32-T64S-S 2M	49-E
300°C		R25	360	ST : 190 SHS: 50	540	ST : 290 SHS: 70	—	E32-T64-2 2M	49-F
350°C *4		R25	1,680	ST : 900 SHS: 240	2,520	ST : 1,350 SHS: 240	1 dia. (5 µm dia./2 µm dia.)	E32-T61-S 2M	49-G
70°C			—					Standard Fiber Units can be used.	—

*1 For continuous operation, use the Fiber Unit between -40 to 90°C.
 *2 For continuous operation, use the Fiber Unit between -40 to 130°C.
 *3 The heat-resistant rating is not the same for all parts of the Fiber Unit. Refer to the dimensions diagrams for details.
 *4 The ambient operating temperature for the E32-T61-S 2M is -60 to 350°C.
 *5 The optical fiber is 2 m long on each side, so the sensing distance is 4,000 mm.

Note 1. The following mode names and response times apply to the modes given in the Sensing distance column.
 [E3X-ZV] GIGA: Giga-power mode (16 ms), HS: High-speed mode (250 µs), ST: Standard mode (1 ms), and SHS: Super-high-speed mode (50 µs)
 [E3NX-FA] GIGA: Giga-power mode (16 ms), HS: High-speed mode (250 µs), ST: Standard mode (1 ms), and SHS: Super-high-speed mode (30 µs)
 2. The values for the minimum sensing object are reference values that indicate values obtained in standard mode with the sensing distance and sensitivity set to the optimum values. The first value is for the E3X-ZV and the second value is for the E3NX-FA.
 3. The sensing distances for the E3NX-FA are values for E3NX-FA□ infrared models varies.
 4. The E3X-HD Series offers the same sensing distance as the E3X-ZV.

Dimensions

Installation Information → 62 to 66 Page

Through-beam Fiber Units (Set of 2)

49-A E32-T51R 2M (Free Cutting)

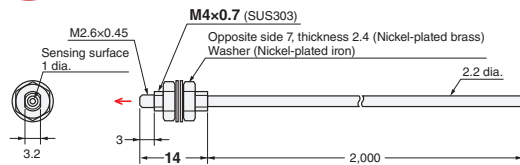

49-B E32-T51 2M (Free Cutting)

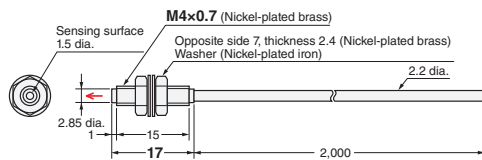

49-C E32-T54 2M (Free Cutting)

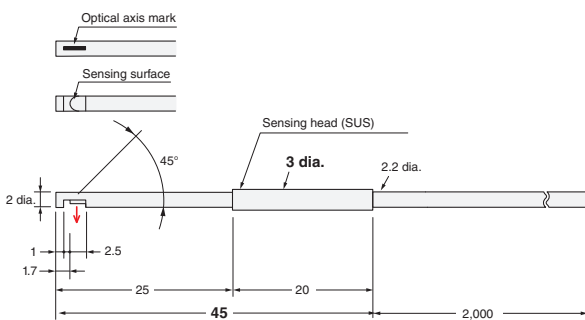

49-D E32-T81R-S 2M (No Cutting)

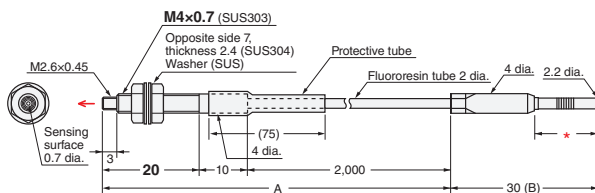

Note: The maximum allowable temperatures for sections A and B are 200°C and 110°C, respectively. The section inserted into the Amplifier Unit (indicated by *) must be maintained within the Amplifier Unit's operating temperature range.

49-E E32-T84S-S 2M (No Cutting)

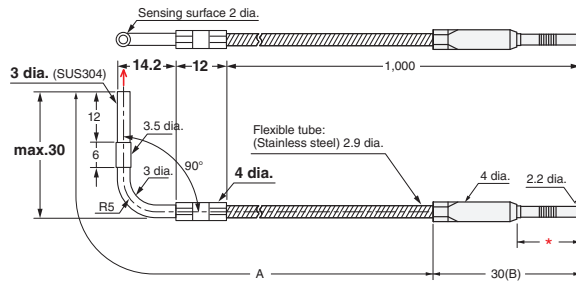

Note: The maximum allowable temperatures for sections A and B are 200°C and 110°C, respectively. The section inserted into the Amplifier Unit (indicated by *) must be maintained within the Amplifier Unit's operating temperature range.

49-F E32-T64-2 2M (No Cutting)

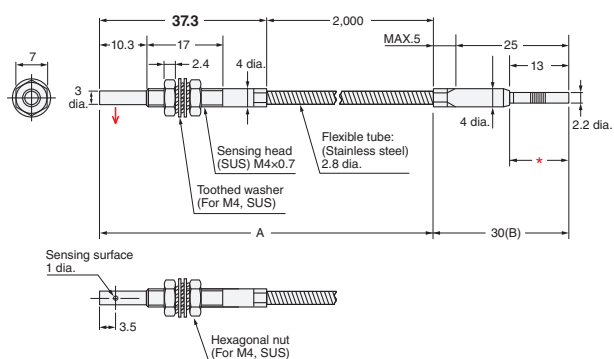

Note: The maximum allowable temperatures for sections A and B are 300°C and 110°C, respectively. The section inserted into the Amplifier Unit (indicated by *) must be maintained within the Amplifier Unit's operating temperature range.

49-G E32-T61-S 2M (No Cutting)

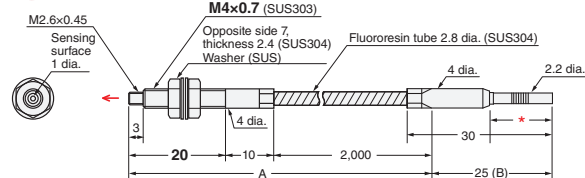

Note: The maximum allowable temperatures for sections A and B are 350°C and 110°C, respectively. The section inserted into the Amplifier Unit (indicated by *) must be maintained within the Amplifier Unit's operating temperature range.

- Reference Information for Model Selection -

And

Long-distance Sensing Applications

A separate Lens Unit can be attached to extend the sensing distance.

→ 32 page

Fiber Sensor
Features

Selection
Guide

Fiber Units

Threaded
Hex-shaped
Cylindrical

Flat
Sleeved

Small Spot
High Power

Narrow view
BGS

Retro-reflective
Limited-reflective

Chemical-resistant,
Oil-resistant
Bending

Heat-resistant
Area Detection

Liquid-level
Vacuum

FPD,
Semi,
Solar

Installation
Information

Fiber Amplifiers,
Communications
Unit, and
Accessories

Technical
Guide and
Precautions

Model Index

Fiber Sensor Features

Selection Guide

Fiber Units

Standard Installation

- Threaded
- Hex-shaped
- Cylindrical

Saving Space

- Flat
- Sleeved

Beam Improvements

- Small Spot
- High Power
- Narrow view
- BGS

Transparent Objects

- Retro-reflective
- Limited-reflective

Environmental Immunity

- Chemical-resistant, Oil-resistant
- Bending
- Heat-resistant

Applications

- Area Detection
- Liquid-level
- Vacuum
- FPD, Semi, Solar

Installation Information

Fiber Amplifiers, Communications Unit, and Accessories

Technical Guide and Precautions

- Wide product variety for temperatures from 100 to 400°C. Select the model according to heat-resistant temperature.

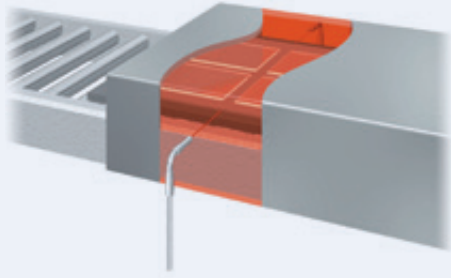

Specifications

Reflective Fiber Units

Heat-resistant temperature	Appearance (mm)	Bending radius of cable	Sensing distance (mm)				Standard sensing object (minimum sensing object)	Models	51 Page Dimensions No.
			E3X-ZV		E3NX-FA				
			GIGA	HS	GIGA	HS			
100°C *1		Flexible, R2	670	ST : 280 SHS: 80	1,000	ST : 420 SHS: 80	(5 μm dia./ 2 μm dia.)	E32-D51R 2M	51-A
150°C *2		R35	1,120	ST : 450 SHS: 144	1,680	ST : 670 SHS: 144	(5 μm dia./ 2 μm dia.)	E32-D51 2M	51-B
200°C *3		R10	420	ST : 180 SHS: 54	630	ST : 270 SHS: 54	(5 μm dia./ 2 μm dia.)	E32-D81R-S 2M	51-C
300°C *3		R25	10 to 20	ST : 10 to 20 SHS: -	10 to 20	ST : 10 to 20 SHS: -	Soda glass with reflection factor of 7%	E32-A08H2 2M	51-D
			1 to 5	ST : 1 to 5 SHS: -	1 to 5	ST : 1 to 5 SHS: -	-	E32-L64 2M	51-E
200°C *3		R25	4 to 10	ST : 4 to 10 SHS: 4 to 10	4 to 10	ST : 4 to 10 SHS: 4 to 10	(5 μm dia./ 2 μm dia.)	E32-L86 2M	51-F
300°C *3		R25	20 to 30	ST : 20 to 30 SHS: -	20 to 30	ST : 20 to 30 SHS: -	End surface of soda glass with reflection factor of 7% (t = 0.7 mm, rounded edges)	E32-A09H2 2M	51-G
350°C *3		R25	420	ST : 180 SHS: 54	630	ST : 270 SHS: 54	(5 μm dia./ 2 μm dia.)	E32-D611-S 2M	51-H
			120	ST : 180 SHS: 36	420	ST : 180 SHS: 36		E32-D61-S 2M	51-I
400°C *3		R25	280	ST : 120 SHS: 36	420	ST : 180 SHS: 36	(5 μm dia./ 2 μm dia.)	E32-D73-S 2M	51-J
70°C			-					Standard Fiber Units can be used.	-

*1 For continuous operation, use the Fiber Unit between -40 to 90°C.
 *2 For continuous operation, use the Fiber Unit between -40 to 130°C.
 *3 The heat-resistant rating is not the same for all parts of the Fiber Unit. Refer to the dimensions diagrams for details.

- Note 1.** The following mode names and response times apply to the modes given in the Sensing distance column.
 [E3X-ZV] GIGA: Giga-power mode (16 ms), HS: High-speed mode (250 μs), ST: Standard mode (1 ms), and SHS: Super-high-speed mode (50 μs)
 [E3NX-FA] GIGA: Giga-power mode (16 ms), HS: High-speed mode (250 μs), ST: Standard mode (1 ms), and SHS: Super-high-speed mode (30 μs)
- The values for the minimum sensing object are reference values that indicate values obtained in standard mode with the sensing distance and sensitivity set to the optimum values. The first value is for the E3X-ZV and the second value is for the E3NX-FA.
 - The sensing distances for Reflective Fiber Units are for white paper.
 - The sensing distances for the E3NX-FA are values for E3NX-FA□ devices. The distance for E3NX-FAH□ infrared models varies.
 - The E3X-HD Series offers the same sensing distance as the E3X-ZV.

Dimensions

Installation Information → 62 to 66 Page

Reflective Fiber Units

51-A E32-D51R 2M (Free Cutting)

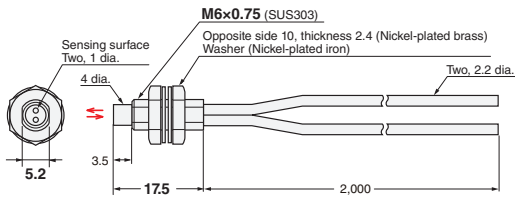

51-B E32-D51 2M (Free Cutting)

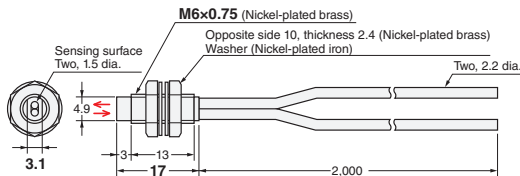

51-C E32-D81R-S 2M (No Cutting)

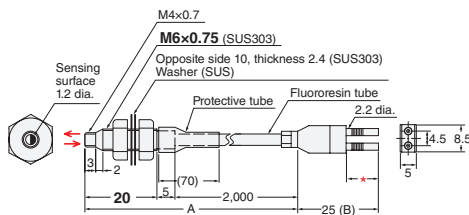

Note: The maximum allowable temperatures for sections A and B are 200°C and 110°C, respectively. The section inserted into the Amplifier Unit (indicated by *) must be maintained within the Amplifier Unit's operating temperature range.

51-D E32-A08H2 2M (No Cutting)

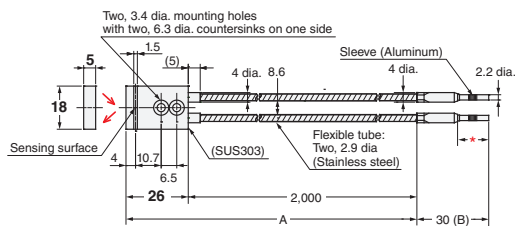

Note: The maximum allowable temperatures for sections A and B are 300°C and 110°C, respectively. The section inserted into the Amplifier Unit (indicated by *) must be maintained within the Amplifier Unit's operating temperature range.

Mounting holes

51-E E32-L64 2M (No Cutting)

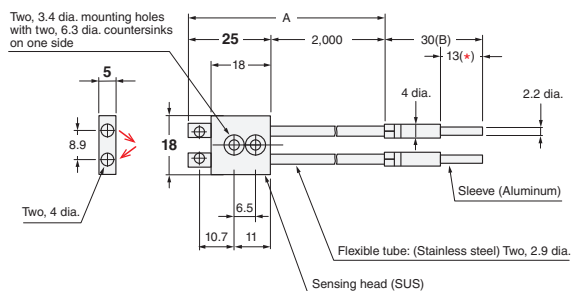

Note: The maximum allowable temperatures for sections A and B are 300°C and 110°C, respectively. The section inserted into the Amplifier Unit (indicated by *) must be maintained within the Amplifier Unit's operating temperature range.

51-F E32-L86 2M (No Cutting)

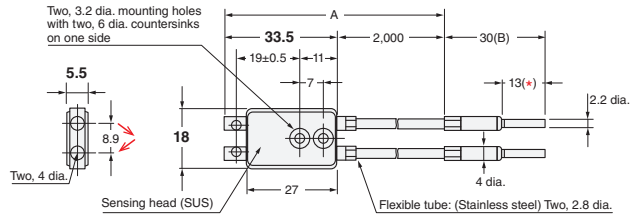

Note: The maximum allowable temperatures for sections A and B are 200°C and 110°C, respectively. The section inserted into the Amplifier Unit (indicated by *) must be maintained within the Amplifier Unit's operating temperature range.

51-G E32-A09H2 2M (No Cutting)

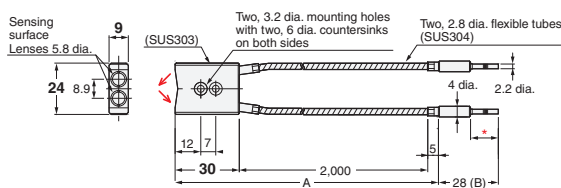

Note: The maximum allowable temperatures for sections A and B are 300°C and 110°C, respectively. The section inserted into the Amplifier Unit (indicated by *) must be maintained within the Amplifier Unit's operating temperature range.

51-H E32-D611-S 2M (No Cutting)

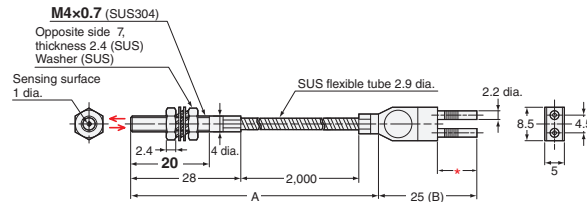

Note: The maximum allowable temperatures for sections A and B are 350°C and 110°C, respectively. The section inserted into the Amplifier Unit (indicated by *) must be maintained within the Amplifier Unit's operating temperature range.

51-I E32-D61-S 2M (No Cutting)

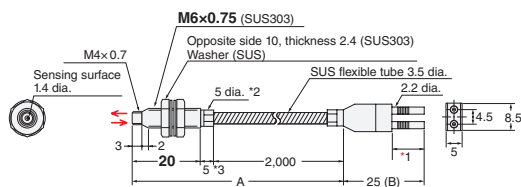

- *2. The diameter is 6 dia. if the fiber length exceeds 10 m.
- *3. The length is 10 if the fiber length exceeds 10 m.

Note: The maximum allowable temperatures for sections A and B are 350°C and 110°C, respectively. The section inserted into the Amplifier Unit (indicated by *) must be maintained within the Amplifier Unit's operating temperature range.

51-J E32-D73-S 2M (No Cutting)

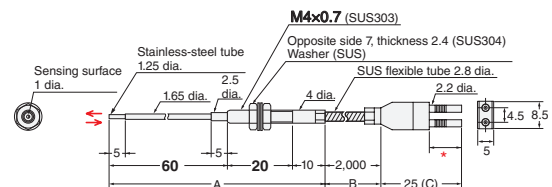

Note: The maximum allowable temperatures for sections A, B, and C are 400°C, 300°C, and 110°C, respectively. The section inserted into the Amplifier Unit (indicated by *) must be maintained within the Amplifier Unit's operating temperature range.

Fiber Sensor Features

Selection Guide

Fiber Units

Threaded	Standard Installation
Hex-shaped	
Cylindrical	
Flat	Saving Space
Sleeved	
Small Spot	Beam Improvements
High Power	
Narrow view	
BGS	Transparent Objects
Retro-reflective	Environmental Immunity
Limited-reflective	
Chemical-resistant, Oil-resistant	
Bending	
Heat-resistant	Applications
Area Detection	
Liquid-level	
Vacuum	
FPD, Semi, Solar	

Installation Information

Fiber Amplifiers, Communications Unit, and Accessories

Technical Guide and Precautions

Model Index

- Threaded
- Hex-shaped
- Cylindrical

- Flat
- Sleeved

- Small Spot
- High Power
- Narrow view
- BGS

- Retro-reflective
- Limited-reflective

- Chemical-resistant, Oil-resistant
- Bending
- Heat-resistant

- Area Detection
- Liquid-level
- Vacuum
- FPD, Semi, Solar

- Area Detection

- Area Detection

- Area Detection

- Area Detection

Detection of falling workpieces

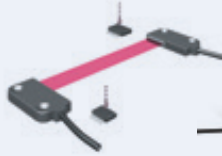

Meander detection

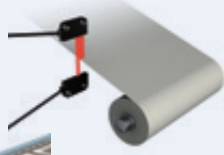

Detection of workpieces with holes

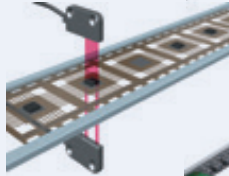

Substrate detection

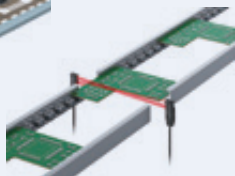

- Area beams are optimum for detecting workpieces presented in inconsistent positions, such as falling workpieces, or for meander detection, or for detecting workpieces with holes.
- This Fiber Unit is ideal for meander detectin because it outputs the digital value in a linear relation to the interrupted light distance.

Characteristics of Light Interruption (Reference Value)

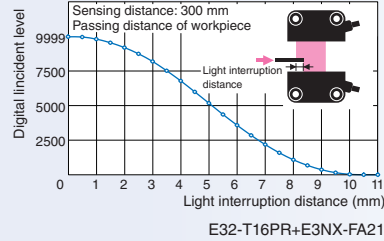

Specifications

Through-beam Fiber Units

Type	Sensing width	Appearance (mm)	Bending radius of cable	Sensing distance (mm)				Optical axis diameter (minimum sensing object)	Models	53 Page Dimensions No.	
				E3X-ZV		E3NX-FA					
				GIGA = HS	Other modes	GIGA = HS	Other modes				
Area	11 mm		Flexible, R1	3,100	ST : 1,700	4,000 *1	ST : 2,550	*2 (0.2 dia./ 0.07 dia.)	E32-T16PR 2M	53-A	
				1,120	SHS: 440	1,680	SHS: 440				
	30 mm		Flexible, R1	2,750	ST : 1,500	4,000 *1	ST : 2,250		—	E32-T16JR 2M	53-B
				960	SHS: 380	1,440	SHS: 380				
Array	10 mm		R5	40 to 420	ST : 40 to 420	40 to 630	ST : 40 to 630	*2 (0.3 dia./ 0.1 dia.)	E32-A13 2M	53-C	
				40 to 420	SHS: 40 to 160	40 to 630	SHS: 40 to 240				
Array	10 mm		R5	4,000 *1	ST : 2,600	4,000 *1	ST : 3,900	*2 (0.3 dia./ 0.1 dia.)	E32-T16WR 2M	53-D	
				1,700	SHS: 680	2,550	SHS: 680				
Array	10 mm		R5	10	ST : 10	10	ST : 10	11 dia.	E32-G16 2M	53-E	
				10	SHS: 10	10	SHS: 10				

*1 The optical fiber is 2 m long on each side, so the sensing distance is 4,000 mm.

*2 The values for the minimum sensing object were obtained for detection in the sensing area with the sensing distance set to 300 mm. (The values are for a stationary sensing object.)

The first value is for the E3X-ZV and the second value is for the E3NX-FA.

Note 1. The sensing distances for the E3NX-FA are values for E3NX-FA□ devices. The distance for E3NX-FAH□ infrared models varies.

2. The E3X-HD Series offers the same sensing distance as the E3X-ZV.

Reflective Fiber Units

Type	Sensing width	Appearance (mm)	Bending radius of cable	Sensing distance (mm)				Optical axis diameter (minimum sensing object)	Model	53 Page Dimensions No.
				E3X-ZV		E3NX-FA				
				GIGA = HS	Other modes	GIGA = HS	Other modes			
Array	11 mm		Bend-resistant, R4	700	ST : 300	1,050	ST : 450	(5 μm dia./ 2 μm dia.)	E32-D36P1 2M	53-F
				200	SHS: 90	300	SHS: 90			

Note 1. The following mode names and response times apply to the modes given in the Sensing distance column.

[E3X-ZV] GIGA: Giga-power mode (16 ms), HS: High-speed mode (250 μs), ST: Standard mode (1 ms), and SHS: Super-high-speed mode (50 μs)

[E3NX-FA] GIGA: Giga-power mode (16 ms), HS: High-speed mode (250 μs), ST: Standard mode (1 ms), and SHS: Super-high-speed mode (30 μs)

2. The values for the minimum sensing object are reference values that indicate values obtained in standard mode with the sensing distance and sensitivity set to the optimum values.

The first value is for the E3X-ZV and the second value is for the E3NX-FA.

3. The sensing distances for the E3NX-FA are values for E3NX-FA□ devices. The distance for E3NX-FAH□ infrared models varies.

4. The E3X-HD Series offers the same sensing distance as the E3X-ZV.

Dimensions

Installation Information → 62 to 66 Page

Through-beam Fiber Units (Set of 2)

53-A E32-T16PR 2M (Free Cutting)

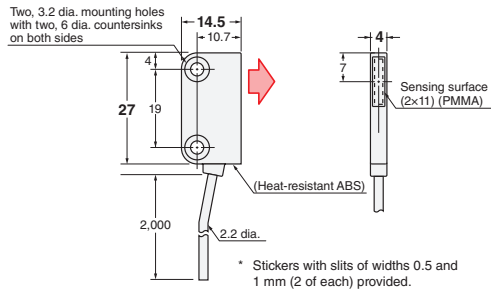

53-B E32-T16JR 2M (Free Cutting)

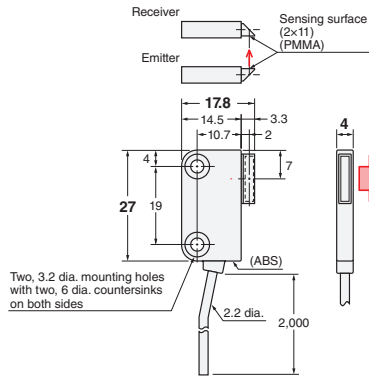

53-C E32-A13 2M (Free Cutting)

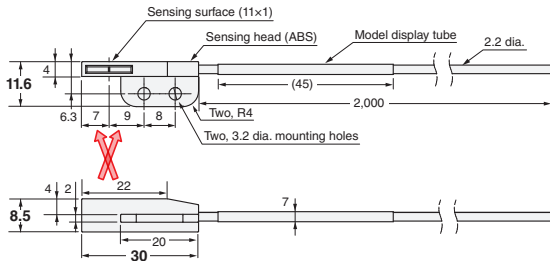

53-D E32-T16WR 2M (Free Cutting)

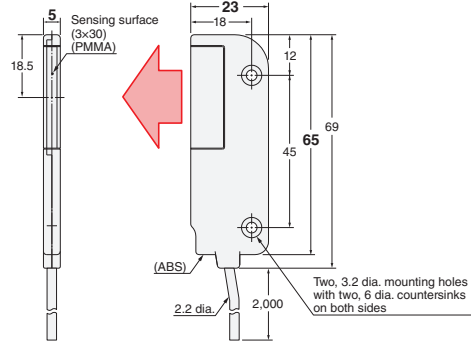

53-E E32-G16 2M

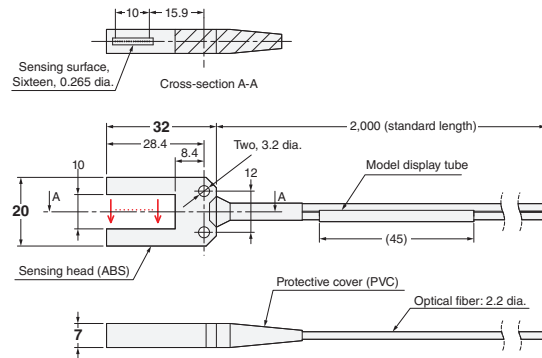

Through-beam Fiber Units (Set of 2)

53-F E32-D36P1 2M (Free Cutting)

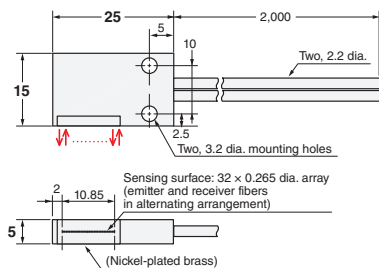

Fiber Sensor Features

Selection Guide

Fiber Units

Threaded	Standard Installation
Hex-shaped	
Cylindrical	
Flat	Saving Space
Sleeved	
Small Spot	Beam Improvements
High Power	
Narrow view	
BGS	
Retro-reflective	Transparent Objects
Limited-reflective	
Chemical-resistant, Oil-resistant	Environmental Immunity
Bending	
Heat-resistant	

Area Detection	Applications
Liquid-level	
Vacuum	
FPD, Semi, Solar	

Installation Information

Fiber Amplifiers, Communications Unit, and Accessories

Technical Guide and Precautions

Model Index

- Threaded
- Hex-shaped
- Cylindrical

- Flat
- Sleeved

- Small Spot
- High Power
- Narrow view
- BGS

- Retro-reflective
- Limited-reflective

- Chemical-resistant, Oil-resistant
- Bending
- Heat-resistant

- Area Detection
- Liquid-level
- Vacuum
- FPD, Semi, Solar



Fiber Units for detecting liquid levels are available in two types: for tube mounting and liquid contact.

▶ **Tube-mounting Types**

Detect the liquid level inside transparent tubes. Strap the Fiber Unit to a tube with band.



▶ **Liquid-contact Type**

Detect the liquid level by direct contact with the liquid. This model has excellent chemical-resistance because the Fiber Unit is covered in fluororesin.

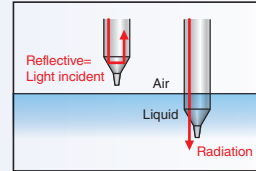

Specifications

Detection scheme	Tube diameter	Features	Appearance (mm)	Bending radius of cable	Applicable range	Optical axis diameter (minimum sensing object)	Models	55 Page Dimensions No.
Tube-mounting	3.2, 6.4 and 9.5 dia.	<ul style="list-style-type: none"> Resistant to bubbles and droplets Residual quantity detection 		Bend-resistant, R4	Applicable tube: Transparent tube with a diameter of 3.2, 6.4, or 9.5 dia. and a recommended wall thickness of 1 mm	—	E32-A01 5M	55-A
	8 to 10 dia.	Ideal for mounting at multilevels		R10	Applicable tube: Transparent tube with a diameter of 8 to 10 dia. and a recommended wall thickness of 1 mm	—	E32-L25T 2M	55-B
	No restrictions	<ul style="list-style-type: none"> Usable on large diameter tubes Resistant to bubbles and droplets 		R4	Applicable tube: Transparent tube (no restrictions on diameter)	—	E32-D36T 2M	55-C
Liquid contact (heat-resistant up to 200°C)	—	—		R40 R25 *3	Liquid-contact Type *1	—	E32-D82F1 4M	55-D

*1 If you want to change the amount of received light, please Refer to the Instruction Sheet of the Fiber Amplifier used.
 *2 The applicable range is the same whether an E3X-ZV series or E3NX-FA series is used. This does not include E3NX-FAH infrared models varies.
 When using a Fiber Amplifier Unit in giga-power mode, level detection may not work depending on the tube diameter. Make sure to confirm operation with the actual tube.
 *3 The bending radius of the sensing section (except for the unbendable section) is 40 mm, and the bending radius of the fiber is 25 mm.

- Reference Information for Model Selection -

Determining the Best Model for Tube-mounted Types

Mounting and conditions	Recommended Unit	Features
When bubbles and the water droplets are generated	E32-A01	<p>This is a Through-beam Model, so the incident light will differ greatly between with and without of liquid. It also uses an area beam, which is less prone to false detection by bubbles and droplets.</p> <div style="display: flex; justify-content: space-around;"> <div style="text-align: center;"> <p>With liquid</p> <p>Light interrupted</p> </div> <div style="text-align: center;"> <p>Without liquid</p> <p>Light incident</p> </div> </div>
Multilevel installation in limited space	E32-L25T	<p>This model is suitable for mounting at multilevels because of the thin type (height: 10 mm).</p>
Mounting on large diameter tubes	E32-D36T	<p>This model has no restrictions on the tube diameter, so it can be mounted on many different tube sizes. It also uses an area beam, which is less prone to false detection by bubbles and droplets.</p> <div style="display: flex; justify-content: space-around;"> <div style="text-align: center;"> <p>With liquid</p> <p>Reflective=Light incident</p> </div> <div style="text-align: center;"> <p>Without liquid</p> <p>Radiation</p> </div> </div>

Dimensions

Installation Information → 62 to 66 Page

55-A E32-A01 5M (Free Cutting)

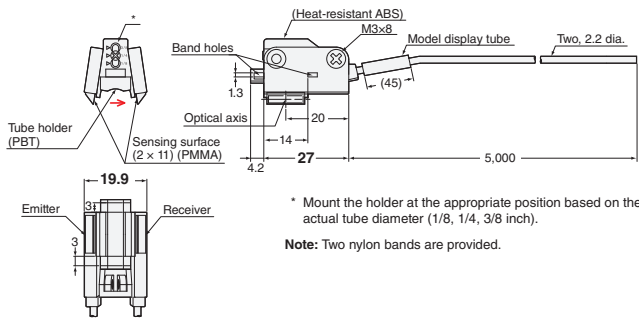

Tube-mounting Examples



55-B E32-L25T 2M (Free Cutting)

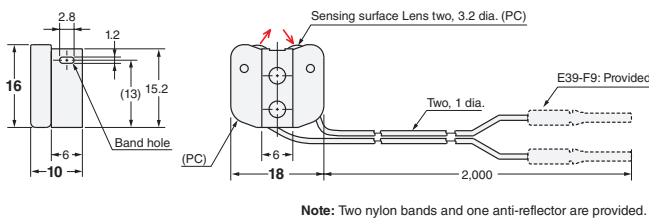

55-C E32-D36T 2M (Free Cutting)

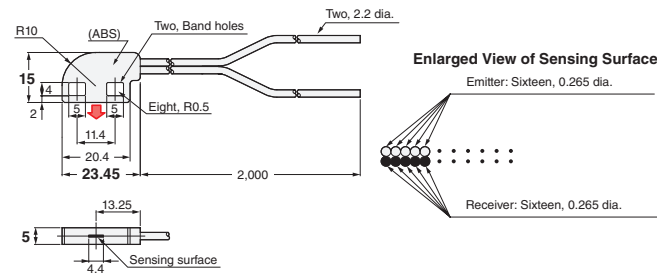

55-D E32-D82F1 4M (Free Cutting)

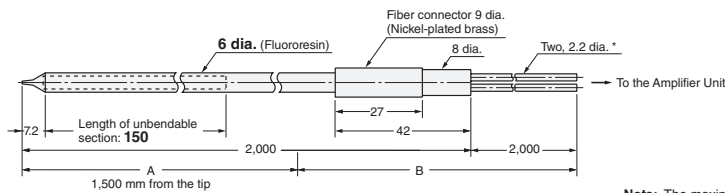

Note: The maximum allowable temperature is 200°C for section A and 85°C for section B.

And

Designed for Safe Residual quantity detection (E32-A01 only)

The E32-A01 Fiber Unit is designed to default to the same output as for liquid absent in the event of a failure, such as when the fiber breaks. This makes it suitable for residual quantity detection.

Trouble (disconnection)	Light interrupted
With liquid	Light interrupted
Without liquid	Light incident

If the failure goes unnoticed, this failsafe design will prevent false detection of liquid when there is no liquid present.

Fiber Sensor Features

Selection Guide

Fiber Units

Threaded
Hex-shaped
Cylindrical

Standard Installation

Flat
Sleeved

Saving Space

Small Spot

High Power

Narrow view

BGS

Retro-reflective

Limited-reflective

Chemical-resistant, Oil-resistant

Bending

Heat-resistant

Area Detection

Liquid-level

Vacuum

FPD, Semi, Solar

Installation Information

Fiber Amplifiers, Communications Unit, and Accessories

Technical Guide and Precautions

Model Index

- Threaded
- Hex-shaped
- Cylindrical

- Flat
- Sleeved

- Small Spot
- High Power
- Narrow view
- BGS

- Retro-reflective
- Limited-reflective

- Chemical-resistant, Oil-resistant
- Bending
- Heat-resistant

- Area Detection
- Liquid-level
- Vacuum
- FPD, Semi, Solar



- Can be used under high vacuums of up to 10^{-5} Pa.
- Available in models with heat resistant up to 120 or 200°C.

Configuration Example for using under vacuum

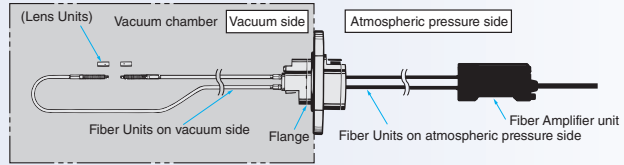

Specifications

Through-beam Fiber Units

Type	Heat-resistant temperature	Appearance (mm)	Bending radius of cable	Sensing distance (mm)						Optical axis diameter (minimum sensing object)	Models	57 Page Dimensions No.
				E3X-ZV			E3NX-FA					
				GIGA	HS	Other modes	GIGA	HS	Other modes			
Vacuum side	120°C		R30	720	ST : 400	1,080	ST : 600	1.2 dia. (10 μm dia./ 4 μm dia.)	E32-T51V 1M	57-A		
		260		SHS: 100	390	SHS: 100						
Vacuum side	200°C		R25	2,000*	ST : 2,000	2,000*	ST : 2,000	4 dia. (0.1 dia./ 0.03 dia.)	E32-T51V 1M + E39-F1V	57-B		
		1,360		SHS: 520	2,000*	SHS: 520						
Atmospheric pressure side	70°C		R25	1,760	ST : 950	2,000*	ST : 1,420	2 dia. (0.1 dia./ 0.03 dia.)	E32-T84SV 1M	57-C		
		640		SHS: 260	960	SHS: 260						
Atmospheric pressure side	70°C			-	ST : -	-	SHS : -	-	E32-T10V 2M	57-D		

* The optical fiber is 2 m long on each side, so the sensing distance is 4,000 mm.

Note 1. The following mode names and response times apply to the modes given in the Sensing distance column.

[E3X-ZV] GIGA: Giga-power mode (16 ms), HS: High-speed mode (250 μs), ST: Standard mode (1 ms), and SHS: Super-high-speed mode (50 μs)
 [E3NX-FA] GIGA: Giga-power mode (16 ms), HS: High-speed mode (250 μs), ST: Standard mode (1 ms), and SHS: Super-high-speed mode (30 μs)

- The values for the minimum sensing object are reference values that indicate values obtained in standard mode with the sensing distance and sensitivity set to the optimum values. The first value is for the E3X-ZV and the second value is for the E3NX-FA.
- The sensing distances for the E3NX-FA are values for E3NX-FA□ infrared models varies.
- The E3X-HD Series offers the same sensing distance as the E3X-ZV.

Flange

Appearance	Type	Models	57 Page Dimensions No.
	4-channel flange	E32-VF4	57-E
	1-channel flange	E32-VF1	57-F

Dimensions

Installation Information → 62 to 66 Page

Through-beam Fiber Units (Set of 2)

57-A E32-T51V 1M (No Cutting)

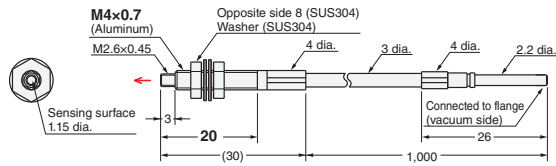

57-B E32-T51V 1M (No Cutting) + E39-F1V

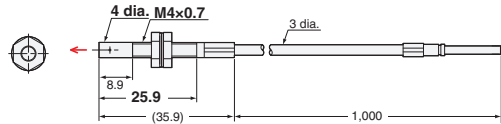

E39-F1V

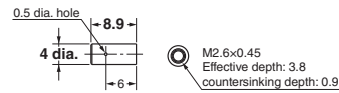

57-C E32-T84SV 1M (No Cutting)

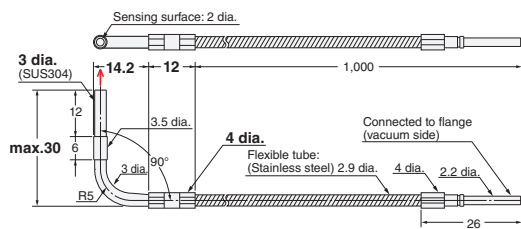

57-D E32-T10V 2M (Free Cutting)

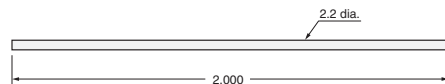

57-E E32-VF4

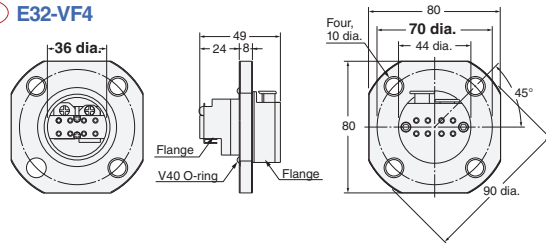

- Note 1.** Mount the Flange so that the V40 O-ring is on the atmospheric-pressure side of the vacuum chamber wall.
2. Mounting-hole dimensions: 38 dia. ±0.5 mm
3. The maximum tightening torque is 9.8 N·m.
4. A V40 O-ring is provided.

53-F E32-VF1

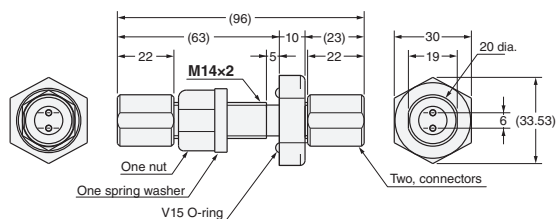

- Note 1.** Mount the Flange so that the V15 O-ring is on the atmospheric-pressure side of the vacuum chamber wall.
2. Mounting-hole dimensions: 14.5 dia. ±0.2 mm
3. The maximum tightening torque is 14.7 N·m for the clamp nut and 1.5 N·m for the connector.
4. A V15 O-ring, nut, spring washer, two connectors, and four O-rings for the fibers are provided.

- Reference Information for Model Selection -

What Is a Vacuum-resistant Fiber Unit?

- The Flange is designed to create an air-tight seal on the vacuum side.
- The fibers and Flange on the vacuum side are made of non-outgassing materials. These parts are inspected, cleaned, and sealed in an air-tight package in a clean room prior to shipment.

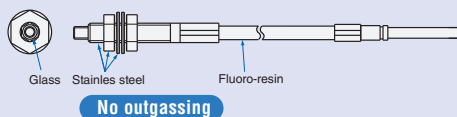

Fiber Sensor
Features

Selection
Guide

Fiber Units

Threaded
Hex-shaped
Cylindrical

Standard Installation

Flat
Sleeved

Saving Space

Small Spot
High Power

Beam Improvements

Narrow view
BGS

Beam Improvements

Retro-reflective
Limited-reflective

Transparent Objects

Chemical-resistant,
Oil-resistant
Bending
Heat-resistant

Environmental Immunity

Area Detection
Liquid-level

Applications

Vacuum
FPD,
Semi,
Solar

Applications

Installation
Information

Installation Information

Fiber Amplifiers,
Communications
Unit, and
Accessories

Fiber Amplifiers,
Communications
Unit, and
Accessories

Technical
Guide and
Precautions

Technical
Guide and
Precautions

Model Index

Model Index

- Threaded
- Hex-shaped
- Cylindrical

- Flat
- Sleeved

- Small Spot
- High Power
- Narrow view
- BGS

- Retro-reflective
- Limited-reflective

- Chemical-resistant, Oil-resistant
- Bending
- Heat-resistant

- Area Detection
- Liquid-level
- Vacuum
- FPD, Semi, Solar

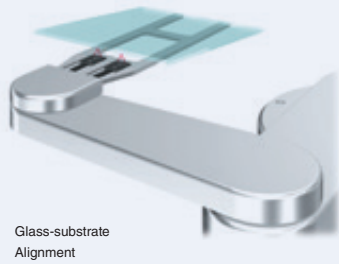

Glass-substrate Alignment

Glass-substrate Alignment

- Detection position accuracy: 0.2 mm max. No variation in detection positions even if the sensing distance changes.
- Tilting workpiece does not affect detection.

Glass-substrate Mapping

Stable detection is possible even for difficult-to-detect curved surfaces.

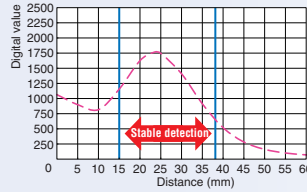

Glass Presence Detection in Wet Processes

- Stable non-contact detection even with warped glass.
- The spherical heads ensure stable detection without being influenced by liquid.

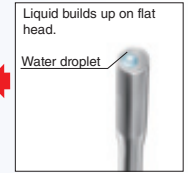
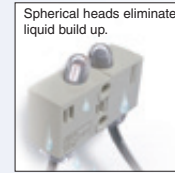
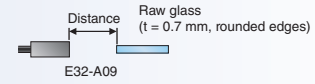
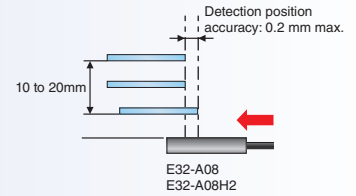

Specifications

Limited-reflective Fiber Units

Application	Ambient temperature	Appearance (mm)	Bending radius of cable	Sensing distance (mm)						Standard sensing object (minimum sensing object)	Models	59 Page Dimensions No.
				E3X-ZV			E3NX-FA					
				GIGA	HS	Other modes	GIGA	HS	Other modes			
Glass presence detection	70°C		R25	0 to 15	ST : 0 to 15	0 to 15	ST : 0 to 15	Soda glass with reflection factor of 7%	E32-L16-N 2M *1	59-A		
				0 to 15	SHS : 0 to 12	0 to 15	SHS : 0 to 12					
Glass-substrate Alignment	300°C		R25	10 to 20	ST : 10 to 20	10 to 20	ST : 10 to 20	End surface of soda glass with reflection factor of 7% (t = 0.7 mm, rounded edges)	E32-A08 2M *1	59-B		
				10 to 20	SHS : -	10 to 20	SHS : -					
Glass-substrate Alignment	70°C		R25	12 to 30	ST : 12 to 30	12 to 30	ST : 12 to 30	End surface of soda glass with reflection factor of 7% (t = 0.7 mm, rounded edges)	E32-A08H2 2M *1	59-C		
				12 to 30	SHS : -	12 to 30	SHS : -					
Mapping of glass substrates	300°C *2		R25	15 to 38	ST : 15 to 38	15 to 38	ST : 15 to 38	End surface of soda glass with reflection factor of 7% (t = 0.7 mm, rounded edges)	E32-A12 2M	59-D		
				15 to 38 (Center 25)	SHS : - (Center 25)	15 to 38 (Center 25)	SHS : - (Center 25)					
Mapping of glass substrates	300°C *2		R25	20 to 30	ST : 20 to 30	20 to 30	ST : 20 to 30	End surface of soda glass with reflection factor of 7% (t = 0.7 mm, rounded edges)	E32-A09 2M	59-E		
				20 to 30 (Center 25)	SHS : - (Center 25)	20 to 30 (Center 25)	SHS : - (Center 25)					
Wet processes (Cleaning, Resist developing, and etching)	60°C		R40	8 to 20 mm from tip of lens (Recommended sensing distance: 11 mm) 19 to 31 mm from center of mounting hole A (Recommended sensing distance: 22 mm)				Glass (t=0.7mm)	E32-L11FP 2M	59-G		
Wet processes (Resist stripping)	85°C			8 to 20 mm from tip of lens (Recommended sensing distance: 11 mm) 32 to 44 mm from center of mounting hole A (Recommended sensing distance: 35 mm)					E32-L11FS 2M	59-H		

*1 If operation is affected by the background, perform power tuning to decrease the incident light level.
*2 The maximum allowable temperature is not the same for all parts of the Fiber Unit. Refer to the dimensions diagrams for details. Must not be repeatedly subject to rapid temperature changes.

Note 1. The following mode names and response times apply to the modes given in the Sensing distance column.
[E3X-ZV] GIGA: Giga-power mode (16 ms), HS: High-speed mode (250 μs), ST: Standard mode (1 ms), and SHS: Super-high-speed mode (50 μs)
[E3NX-FA] GIGA: Giga-power mode (16 ms), HS: High-speed mode (250 μs), ST: Standard mode (1 ms), and SHS: Super-high-speed mode (30 μs)
2. The sensing distances for the E3NX-FA are values for E3NX-FA□ devices. The distance for E3NX-FAH□ infrared models varies.
3. The E3X-HD Series offers the same sensing distance as the E3X-ZV.

Dimensions

Installation Information → 62 to 66 Page

Limited-reflective Fiber Units

59-A E32-L16-N 2M (Free Cutting)

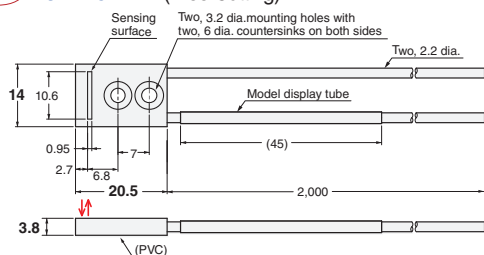

59-B E32-A08 2M (Free Cutting)

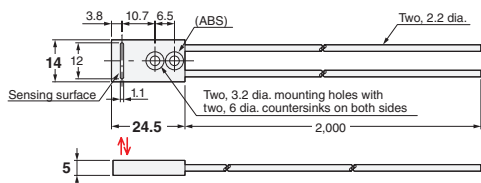

59-C E32-A08H2 2M (No Cutting)

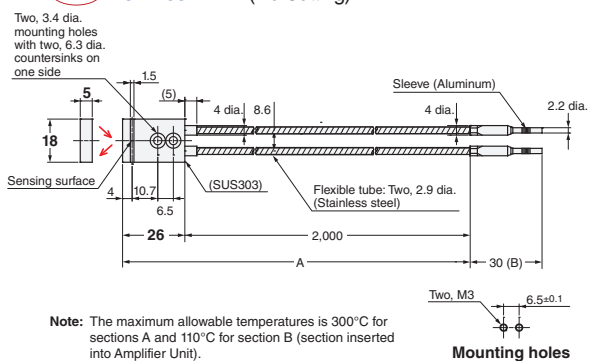

59-D E32-A12 2M (Free Cutting)

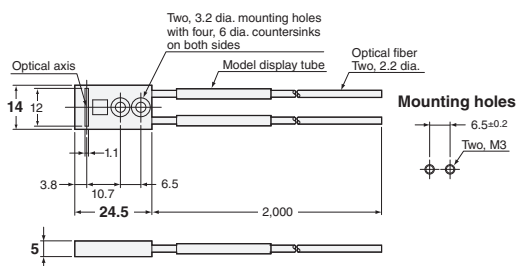

59-E E32-A09 2M (Free Cutting)

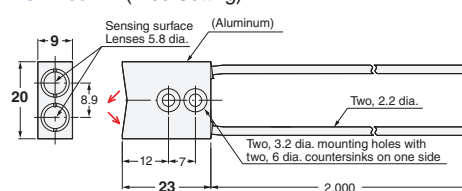

59-F E32-A09H2 2M (No Cutting)

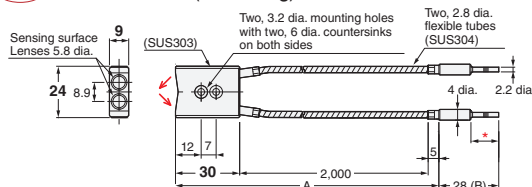

Note: The maximum allowable temperatures for sections A and B are 300°C and 110°C, respectively. The section inserted into the Amplifier Unit (indicated by *) must be maintained within the Amplifier Unit's operating temperature range.

59-G E32-L11FP 2M (Free Cutting)

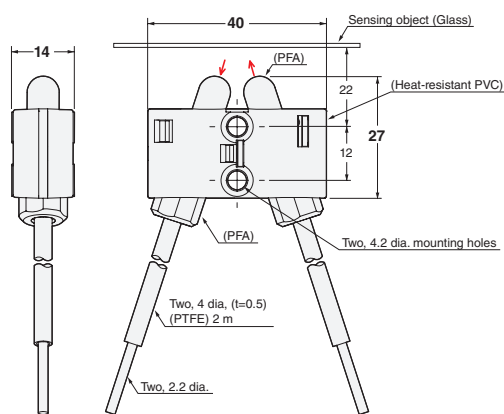

59-H E32-L11FS 2M (Free Cutting)

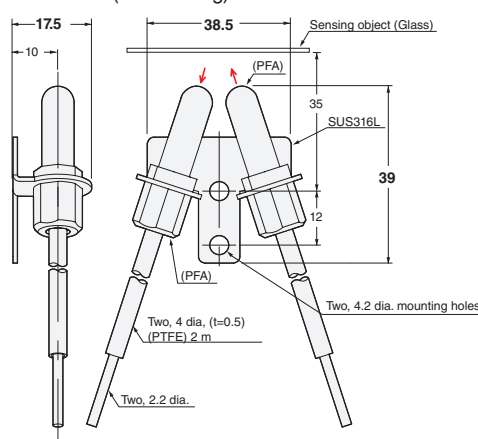

Fiber Sensor Features	
Selection Guide	
Fiber Units	
Threaded	Standard Installation
Hex-shaped	
Cylindrical	
Flat	Saving Space
Sleeved	
Small Spot	Beam Improvements
High Power	
Narrow view	
BGS	
Retro-reflective	Transparent Objects
Limited-reflective	
Chemical-resistant, Oil-resistant	Environmental Immunity
Bending	
Heat-resistant	
Area Detection	Applications
Liquid-level	
Vacuum	
FPD, Semi, Solar	
Installation Information	
Fiber Amplifiers, Communications Unit, and Accessories	
Technical Guide and Precautions	
Model Index	

- Threaded
- Hex-shaped
- Cylindrical

- Flat
- Sleeved

- Small Spot
- High Power
- Narrow view
- BGS

- Retro-reflective
- Limited-reflective

- Chemical-resistant, Oil-resistant
- Bending
- Heat-resistant

- Area Detection
- Liquid-level
- Vacuum
- FPD, Semi, Solar

-

-

-

-



Wafer Mapping

• Wafer Mapping

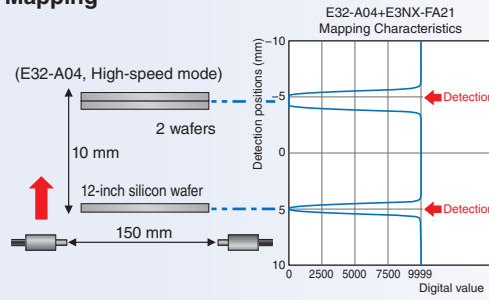

- ▶ Thin-profile design enables easy mounting on robot arms.
- ▶ Easy to adjust optical axis.
(Typical alignment error between mechanical and optical axes is only ±0.1°.)
- ▶ Reliably wafer detection, even when stacked closely together.

Specifications

Through-beam Fiber Units

Application	Ambient temperature	Aperture angle	Appearance (mm)	Bending radius of cable	Sensing distance (mm)				Optical axis diameter (minimum sensing object)	Models	61 Page Dimensions No.				
					E3X-ZV		E3NX-FA								
					GIGA	HS	Other modes	GIGA				HS	Other modes		
Wafer Mapping	70°C	1.5°	<p>Thickness: 3 mm IP50</p>	Flexible, R1	3,220		ST : 1,780	4,000 *	2 dia. (0.1 dia./0.03 dia.)	E32-A03 2M	61-A				
					1,200		SHS: 500	1,800		SHS: 500	E32-A03-1 2M	61-B			
			<p>24.5 10 ±0.3 IP50</p>	R10	2,500		ST : 1,400	2,500		ST : 1,400	SHS: 380	940	SHS: 380	E32-A03-2 2M	61-C
					940		SHS: 380	940		SHS: 380					
			<p>Thickness: 2 mm IP50</p>	R10	1,280		ST : 680	1,920		ST : 1,020	SHS: 200	450	SHS: 200	E32-A04 2M	61-D
					450		SHS: 200	670		SHS: 200					
		<p>21 9 ±0.12 IP50</p>	R10	1,280		ST : 680	1,920	ST : 1,020	SHS: 200	450	SHS: 200	E32-A04-1 2M	61-E		
				450		SHS: 200	670	SHS: 200							
		<p>20.5 2 IP50</p>	R10	960		ST : 510	1,440	ST : 780	SHS: 150	335	SHS: 150	E32-A04-8 2M	61-F		
				335		SHS: 150	500	SHS: 150							
<p>20.5 3.5 dia. IP50</p>	Flexible, R1	4,000 *		ST : 2,200	4,000 *	ST : 3,300	SHS: 580	1,460	SHS: 580	E32-T24SR 2M	61-G				
		1,460		SHS: 580	2,190	SHS: 580									
<p>20.5 3.5 dia. IP50</p>	R10	4,000 *		ST : 2,600	4,000 *	ST : 3,900	SHS: 700	1,740	SHS: 700	E32-T24S 2M	61-H				
		1,740		SHS: 700	2,610	SHS: 700									

* The optical fiber is 2 m long on each side, so the sensing distance is 4,000 mm.

Note 1. The following mode names and response times apply to the modes given in the Sensing distance column.

[E3X-ZV] GIGA: Giga-power mode (16 ms), HS: High-speed mode (250 μs), ST: Standard mode (1 ms), and SHS: Super-high-speed mode (50 μs)

[E3NX-FA] GIGA: Giga-power mode (16 ms), HS: High-speed mode (250 μs), ST: Standard mode (1 ms), and SHS: Super-high-speed mode (30 μs)

2. The values for the minimum sensing object are reference values that indicate values obtained in standard mode with the sensing distance and sensitivity set to the optimum values.

The first value is for the E3X-ZV and the second value is for the E3NX-FA.

3. The sensing distances for the E3NX-FA are values for E3NX-FA□ devices. The distance for E3NX-FAH□ infrared models varies.

4. The E3X-HD Series offers the same sensing distance as the E3X-ZV.

Threaded
Hex-shaped
CylindricalFlat
SleevedSmall Spot
High Power
Narrow
view
BGSRetro-
reflective
Limited-
reflectiveChemical-
resistant,
Oil-resistant
Bending
Heat-
resistantArea
Detection
Liquid-level
Vacuum
FPD,
Semi,
Solar

Models	Installation			Cable						Weight (packed state) (g)	Dimensions Page No.
	Ambient temperature	Tightening torque	Mounting hole	Bending radius	Unbendable length*1	Tensile strength	Sheath material	Core material	Emitter/receiver differentiation		
E32-A01 5M	-40 to 70°C	0.03N·m	–	R4	10	9.8N	Fluororesin	Plastic	None	200	55 Page (55-A)
E32-A03 2M	-40 to 70°C	0.29N·m	–	R1	0	9.8N	Polyethylene	Plastic	None	40	35 Page (35-A) 61 Page (61-A)
E32-A03-1 2M	-40 to 70°C	0.29N·m	–	R10	10	9.8N	Polyethylene	Plastic	None	50	35 Page (35-B) 61 Page (61-B)
E32-A03-2 2M	-40 to 70°C	0.29N·m	–	R10	10	9.8N	Polyethylene	Plastic	Slit on receiver side	–	61 Page (61-C)
E32-A04 2M	-40 to 70°C	0.29N·m	2.2 ^{+0.5} / ₀ dia.	R10	10	9.8N	Polyethylene	Plastic	None	40	35 Page (35-C) 61 Page (61-D)
E32-A04-1 2M	-40 to 70°C	0.29N·m	–	R10	10	9.8N	Polyethylene	Plastic	None	–	61 Page (61-E)
E32-A04-8 2M	-25 to 105°C	0.29N·m	–	R10	10	9.8N	Fluororesin	Plastic	None	80	61 Page (61-F)
E32-A08 2M	-40 to 70°C	0.53N·m	–	R25	10	9.8N	Polyethylene	Plastic	None	60	41 Page (41-C) 59 Page (59-B)
E32-A08H2 2M	-40 to 300°C *2	0.53N·m	–	R25	10	29.4N	SUS	Glass	None	240	51 Page (51-D) 59 Page (59-C)
E32-A09 2M	-40 to 70°C	0.53N·m	–	R25	10	9.8N	Polyethylene	Plastic	None	60	41 Page (41-F) 59 Page (59-E)
E32-A09H2 2M	-40 to 300°C *2, *3	0.53N·m	–	R25	10	9.8N	SUS	Glass	None	230	51 Page (51-G) 59 Page (59-F)
E32-A12 2M	-40 to 70°C	0.53N·m	–	R25	10	9.8N	Polyethylene	Plastic	None	60	41 Page (41-D) 59 Page (59-D)
E32-A13 2M	-25 to 70°C	0.29N·m	–	R1	0	9.8N	PVC	Plastic	None	–	53 Page (53-C)
E32-C21N 2M	-40 to 70°C	0.29N·m	3.2 ^{+0.5} / ₀ dia. *4	R2	0	9.8N	Polyethylene	Plastic	White line on emitter cable	30	11 Page (11-D)
E32-C31 2M	-40 to 70°C	0.78N·m	3.2 ^{+0.5} / ₀ dia. *4	R25	10	9.8N	Polyethylene	Plastic	White line on emitter cable	40	09 Page (09-D)
E32-C31M 1M	-40 to 70°C	0.78N·m	3.2 ^{+0.5} / ₀ dia. *4	R10	10	9.8N	Polyethylene	Plastic	White line on emitter cable	40	09 Page (09-E)
E32-C31N 2M	-40 to 70°C	0.29N·m	3.2 ^{+0.5} / ₀ dia. *4	R4	0	9.8N	PVC and Polyethylene	Plastic	White line on emitter cable	40	09 Page (09-A)
E32-C41 1M	-40 to 70°C	0.78N·m	3.2 ^{+0.5} / ₀ dia. *4	R25	10	9.8N	Polyethylene	Plastic	White tube on emitter cable	30	27 Page (27-A), (27-D)
E32-C42 1M	-40 to 70°C	0.29N·m	2.2 ^{+0.5} / ₀ dia.	R25	10	9.8N	Polyethylene	Plastic	White tube on emitter cable	30	25 Page (25-A), (25-B)
E32-C42S 1M	-40 to 70°C	0.29N·m	3.2 ^{+0.5} / ₀ dia.	R25	10	4N	Polyolefin	Plastic	White tube on emitter cable	30	25 Page (25-E)
E32-CC200 2M	-40 to 70°C	0.98N·m	6.2 ^{+0.5} / ₀ dia.	R25	10	29.4N	Polyethylene	Plastic	White line on emitter cable	40	09 Page (09-H)
E32-C91N 2M	-40 to 70°C	0.98N·m	6.2 ^{+0.5} / ₀ dia.	R4	0	29.4N	Polyethylene	Plastic	White line on emitter cable	36	09 Page (09-B) 11 Page (11-F)
E32-D11 2M	-40 to 70°C	0.98N·m	6.2 ^{+0.5} / ₀ dia.	R4	10	29.4N	PVC	Plastic	None	50	47 Page (47-E)
E32-D11R 2M	-40 to 70°C	0.98N·m	6.2 ^{+0.5} / ₀ dia.	R1	0	29.4N	PVC	Plastic	None	50	09 Page (09-G)
E32-D11U 2M	-40 to 70°C	0.98N·m	6.2 ^{+0.5} / ₀ dia.	R4	10	29.4N	Fluororesin	Plastic	None	60	43 Page (43-I)
E32-D12F 2M	-40 to 70°C	0.78N·m	6.5 ^{+0.5} / ₀ dia.	R40	10	29.4N	Fluororesin	Plastic	None	190	43 Page (43-H)
E32-D14LR 2M	-40 to 70°C	0.98N·m	–	R1	0	29.4N	PVC	Plastic	None	100	15 Page (15-G)
E32-D15XR 2M	-40 to 70°C	0.15N·m	–	R1	0	29.4N	PVC	Plastic	None	60	19 Page (19-A)
E32-D15YR 2M	-40 to 70°C	0.15N·m	–	R1	0	29.4N	PVC	Plastic	None	60	19 Page (19-C)
E32-D15ZR 2M	-40 to 70°C	0.15N·m	–	R1	0	29.4N	PVC	Plastic	None	60	19 Page (19-E)
E32-D16 2M	-40 to 70°C	0.53N·m	–	R4	10	29.4N	PVC	Plastic	None	70	29 Page (29-E)
E32-D21 2M	-40 to 70°C	0.78N·m	3.2 ^{+0.5} / ₀ dia. *4	R4	10	9.8N	PVC	Plastic	None	20	47 Page (47-B)
E32-D211R 2M	-40 to 70°C	0.78N·m	4.2 ^{+0.5} / ₀ dia.	R1	0	9.8N	Polyethylene	Plastic	None	40	09 Page (09-F)
E32-D21B 2M	-40 to 70°C	0.78N·m	4.2 ^{+0.5} / ₀ dia.	R4	10	9.8N	PVC	Plastic	None	40	47 Page (47-D)

*1 Unbendable length of cable from fiber head.

Do not bend the cable for at least 20 mm from where the cable inserts into the Fiber Amplifier Unit.

*2 The heat-resistant rating is not the same for all parts of the Fiber Unit. Refer to the dimensions diagrams for details.

*3 Avoid rapid temperature changes.

*4 For embedded mounting, prepare a hole with a diameter of 2.6 mm.

Models	Installation			Cable						Weight (packed state) (g)	Dimensions Page No.
	Ambient temperature	Tightening torque	Mounting hole	Bending radius	Unbendable length*1	Tensile strength	Sheath material	Core material	Emitter/receiver differentiation		
E32-D21N 2M	-40 to 70°C	0.78N · m	4.2 ^{+0.5} ₀ dia.	R2	0	9.8N	Polyethylene	Plastic	None	30	11 Page (11-E)
E32-D21R 2M	-40 to 70°C	0.78N · m	3.2 ^{+0.5} ₀ dia. *2	R1	0	9.8N	Polyethylene	Plastic	None	20	09 Page (09-C)
E32-D21-S3 2M	-40 to 70°C	0.78N · m	4.2 ^{+0.5} ₀ dia.	R10	10	9.8N	Polyethylene	Plastic	None	50	23 Page (23-J)
E32-D221B 2M	-40 to 70°C	0.29N · m	3.2 ^{+0.5} ₀ dia.	R4	10	9.8N	PVC	Plastic	None	40	15 Page (15-D) 47 Page (47-C)
E32-D22B 2M	-40 to 70°C	0.2N · m	1.7 ^{+0.5} ₀ dia.	R4	10	9.8N	PVC	Plastic	None	30	15 Page (15-A) 47 Page (47-A)
E32-D22R 2M	-40 to 70°C	0.29N · m	3.2 ^{+0.5} ₀ dia.	R1	0	9.8N	Polyethylene	Plastic	None	40	15 Page (15-C)
E32-D22-S1 2M	-40 to 70°C	0.29N · m	4.2 ^{+0.5} ₀ dia.	R10	10	9.8N	Polyethylene	Plastic	None	45	23 Page (23-I)
E32-D24R 2M	-40 to 70°C	0.29N · m	3.2 ^{+0.5} ₀ dia.	R1	0	9.8N	Polyethylene	Plastic	None	40	23 Page (23-A)
E32-D24-S2 2M	-40 to 70°C	0.29N · m	5 ^{+0.5} ₀ dia.	R25	10	19.6N	Polyethylene	Plastic	None	55	23 Page (23-B)
E32-D25XB 2M	-40 to 70°C	0.15N · m	-	R4	10	9.8N	PVC	Plastic	None	40	47 Page (47-F)
E32-D25XR 2M	-40 to 70°C	0.15N · m	-	R1	0	9.8N	Polyethylene	Plastic	None	40	19 Page (19-B)
E32-D25YR 2M	-40 to 70°C	0.15N · m	-	R1	0	9.8N	Polyethylene	Plastic	None	40	19 Page (19-D)
E32-D25ZR 2M	-40 to 70°C	0.15N · m	-	R1	0	9.8N	Polyethylene	Plastic	None	40	19 Page (19-F)
E32-D25-S3 2M	-40 to 70°C	0.29N · m	-	R10	10	9.8N	Polyethylene	Plastic	None	50	23 Page (23-L)
E32-D31-S1 0.5M	-40 to 70°C	0.78N · m	3.2 ^{+0.5} ₀ dia. *2	R4	10	9.8N	Polyolefin	Plastic	None	35	23 Page (23-G)
E32-D32L 2M	-40 to 70°C	0.29N · m	3.2 ^{+0.5} ₀ dia.	R25	10	29.4N	Polyethylene	Plastic	Yellow dotted line on emitter cable	50	15 Page (15-E)
E32-D32-S1 0.5M	-40 to 70°C	0.29N · m	3.2 ^{+0.5} ₀ dia.	R4	10	9.8N	Polyolefin	Plastic	None	35	23 Page (23-F)
E32-D33 2M	-40 to 70°C	0.29N · m	3.2 ^{+0.5} ₀ dia.	R25	10	9.8N	Polyethylene	Plastic	None	40	15 Page (15-F) 23 Page (23-E)
E32-D331 2M	-40 to 70°C	0.29N · m	2.2 ^{+0.5} ₀ dia.	R4	10	9.8N	Polyethylene	Plastic	None	30	23 Page (23-D)
E32-D36P1 2M	-40 to 70°C	0.78N · m	-	R4	10	29.4N	Polyethylene	Plastic	None	60	53 Page (53-F)
E32-D36T 2M	-40 to 70°C	-	-	R4	10	29.4N	Polyethylene	Plastic	None	190	55 Page (55-C)
E32-D43M 1M	-40 to 70°C	0.29N · m	1.7 ^{+0.5} ₀ dia.	R4	10	9.8N	Polyethylene	Plastic	None	30	15 Page (15-B) 23 Page (23-C)
E32-D51 2M	-40 to 150°C *3	0.98N · m	6.2 ^{+0.5} ₀ dia.	R35	10	29.4N	Fluoresin	Plastic	None	60	51 Page (51-B)
E32-D51R 2M	-40 to 100°C *4	0.98N · m	6.2 ^{+0.5} ₀ dia.	R2	0	29.4N	Polyurethane	Plastic	None	60	51 Page (51-A)
E32-D61-S 2M	-60 to 350°C *5	0.98N · m	6.2 ^{+0.5} ₀ dia.	R25	10	29.4N	SUS	Glass	None	190	51 Page (51-I)
E32-D611-S 2M	-60 to 350°C *5	0.98N · m	4.2 ^{+0.5} ₀ dia.	R25	10	29.4N	SUS	Glass	None	170	51 Page (51-H)
E32-D73-S 2M	-40 to 400°C *5	0.78N · m	4.2 ^{+0.5} ₀ dia.	R25	10	29.4N	SUS	Glass	None	170	51 Page (51-J)
E32-D81R-S 2M	-40 to 200°C *5	0.78N · m	6.2 ^{+0.5} ₀ dia.	R10	10	9.8N	Fluoresin	Glass	None	70	51 Page (51-C)
E32-D82F1 4M	-40 to 200°C	0.29N · m	6.5 ^{+0.5} ₀ dia.	R25	10	29.4N	Fluoresin	Plastic	None	450	55 Page (55-D)
E32-DC200BR 2M	-40 to 70°C	0.98N · m	6.2 ^{+0.5} ₀ dia.	R1	0	29.4N	PVC	Plastic	None	60	23 Page (23-K)
E32-DC200F4R 2M	-40 to 70°C	0.78N · m	3.2 ^{+0.5} ₀ dia. *2	R1	0	9.8N	Polyethylene	Plastic	None	40	23 Page (23-H)
E32-G16 2M	-40 to 70°C	0.53N · m	-	R5	0*6	29.4N	Polyethylene	Plastic	-	51	53 Page (53-E)
E32-L11FP 2M	-10 to 60°C	0.78N · m	-	R40	10	9.8N	Fluoresin	Plastic	None	310	43 Page (43-F) 59 Page (59-G)
E32-L11FS 2M	-10 to 85°C	0.78N · m	-	R40	10	9.8N	Fluoresin	Plastic	None	310	43 Page (43-G) 59 Page (59-H)

*1 Unbendable length of cable from fiber head.
 Do not bend the cable for at least 20 mm from where the cable inserts into the Fiber Amplifier Unit.
 *2 For embedded mounting, prepare a hole with a diameter of 2.6 mm.
 *3 For continuous operation, use the Fiber Unit between -40 to 130°C.
 *4 For continuous operation, use the Fiber Unit between -40 to 90°C.
 *5 The heat-resistant rating is not the same for all parts of the Fiber Unit. Refer to the dimensions diagrams for details.
 *6 The bending radius of the protective cover (PVC, 25 mm) is 10 mm min.

Threaded	Standard Installation
Hex-shaped	
Cylindrical	
Flat	Saving Space
Sleeved	
Small Spot	Beam Improvements
High Power	
Narrow view	
BGS	Transparent Objects
Retro-reflective	
Limited-reflective	
Chemical-resistant, Oil-resistant	Environmental Immunity
Bending	
Heat-resistant	Applications
Area Detection	
Liquid-level	Applications
Vacuum	
FPD, Semi, Solar	

Models	Installation			Cable						Weight (packed state) (g)	Dimensions Page No.
	Ambient temperature	Tightening torque	Mounting hole	Bending radius	Unbendable length*1	Tensile strength	Sheath material	Core material	Emitter/receiver differentiation		
E32-L15 2M	-40 to 70°C	0.53N · m	–	R25	10	29.4N	Polyethylene	Plastic	White tube on emitter cable	60	25 Page (25-F)
E32-L16-N 2M	-40 to 70°C	0.29N · m	–	R25	10	29.4N	Polyethylene	Plastic	None	60	37 Page (37-A) 41 Page (41-B) 59 Page (59-A)
E32-L24S 2M	-40 to 70°C	0.29N · m	–	R10	10	9.8N	Polyethylene	Plastic	None	40	37 Page (37-B) 41 Page (41-A)
E32-L25L 2M	-40 to 105°C *2	0.29N · m	–	R10	10	9.8N	Polyethylene	Plastic	None	40	37 Page (37-C) 41 Page (41-E)
E32-L25T 2M	-40 to 70°C	–	–	R10	10	9.8N	Polyethylene	Plastic	None	40	55 Page (55-B)
E32-L64 2M	-40 to 300°C *3	0.54N · m	–	R25	0	9.8N	SUS	Glass	None	220	51 Page (51-E)
E32-L86 2M	-40 to 200°C *3	0.54N · m	–	R25	0	9.8N	SUS	Glass	None	205	51 Page (51-F)
E32-LD11 2M	-40 to 70°C	0.98N · m	–	R25	10	29.4N	Polyethylene	Plastic	None	40	09 Page (09-I)
E32-LD11N 2M	-40 to 70°C	0.98N · m	6.2 ^{+0.5} ₀ dia.	R2	0	29.4N	Polyethylene	Plastic	None	40	11 Page (11-C)
E32-LD11R 2M	-40 to 70°C	0.98N · m	–	R1	0	29.4N	Polyethylene	Plastic	None	40	09 Page (09-I)
E32-LR11NP 2M	-40 to 70°C *4	0.98N · m	6.2 ^{+0.5} ₀ dia.	R2	0	29.4N	Polyethylene	Plastic	None	40	39 Page (39-A) 11 Page (11-G)
E32-LT11 2M	-40 to 70°C	0.78N · m	–	R25	10	29.4N	Polyethylene	Plastic	None	40	07 Page (07-C) 29 Page (29-C)
E32-LT11N 2M	-40 to 70°C	0.78N · m	4.2 ^{+0.5} ₀ dia.	R2	0	29.4N	Polyethylene	Plastic	None	40	29 Page (29-A) 11 Page (11-A)
E32-LT11R 2M	-40 to 70°C	0.78N · m	–	R1	0	29.4N	Polyethylene	Plastic	None	40	07 Page (07-C) 29 Page (29-C)
E32-LT35Z 2M	-40 to 70°C	0.15N · m	–	R1	0	9.8N	Polyethylene	Plastic	None	25	17 Page (17-G)
E32-R16 2M	-25 to 55°C	0.54N · m	–	R25	10	29.4N	Polyethylene	Plastic	None	220 (E39-R1 included.)	39 Page (39-B)
E32-R21 2M	-40 to 70°C	0.39N · m	6.2 ^{+0.5} ₀ dia.	R10	10	9.8N	Polyethylene	Plastic	None	70 (E39-R3 included.)	39 Page (39-C)
E32-T10V 2M	-25 to 70°C	0.3N · m	–	R25	10	29.4N	Fluoresin	Plastic	None	170	57 Page (57-D)
E32-T11 2M	-40 to 70°C	0.78N · m	4.2 ^{+0.5} ₀ dia.	R4	10	29.4N	PVC	Plastic	None	40	45 Page (45-C)
E32-T11F 2M	-40 to 70°C	0.29N · m	–	R4	10	29.4N	Fluoresin	Plastic	None	60	43 Page (43-C)
E32-T11N 2M	-40 to 70°C	0.78N · m	4.2 ^{+0.5} ₀ dia.	R1	0	29.4N	PVC	Plastic	None	70	07 Page (07-A) 11 Page (11-B)
E32-T11NF 2M	-25 to 70°C	12N · m	8.5 ^{+0.5} ₀ dia.	R1	0	29.4N	Fluoresin	Plastic	None	80	43 Page (43-A)
E32-T11NFS 2M	-25 to 70°C	0.78N · m	4.2 ^{+0.5} ₀ dia.	R1	0	29.4N	Fluoresin	Plastic	None	70	43 Page (43-A2)
E32-T11R 2M	-40 to 70°C	0.78N · m	4.2 ^{+0.5} ₀ dia.	R1	0	29.4N	PVC	Plastic	None	50	07 Page (07-B) 11 Page (11-B)
E32-T12F 2M	-40 to 70°C	0.78N · m	5.5 ^{+0.5} ₀ dia.	R40	10	29.4N	Fluoresin	Plastic	None	210	43 Page (43-B)
E32-T12R 2M	-40 to 70°C	0.29N · m	3.2 ^{+0.5} ₀ dia.	R1	0	29.4N	PVC	Plastic	None	60	13 Page (13-C)
E32-T14 2M	-40 to 70°C	0.49N · m	–	R25	10	29.4N	Polyethylene	Plastic	None	60	29 Page (29-D)
E32-T14F 2M	-40 to 70°C	0.78N · m	5.5 ^{+0.5} ₀ dia.	R40	10	29.4N	Fluoresin	Plastic	None	220	43 Page (43-D)
E32-T14LR 2M	-40 to 70°C	0.29N · m	3.2 ^{+0.5} ₀ dia.	R1	0	29.4N	PVC	Plastic	None	60	13 Page (13-D)
E32-T15XR 2M	-40 to 70°C	0.15N · m	–	R1	0	29.4N	PVC	Plastic	None	60	17 Page (17-A)
E32-T15YR 2M	-40 to 70°C	0.15N · m	–	R1	0	29.4N	PVC	Plastic	None	60	17 Page (17-C)
E32-T15ZR 2M	-40 to 70°C	0.15N · m	–	R1	0	29.4N	PVC	Plastic	None	60	17 Page (17-E)
E32-T16JR 2M	-40 to 70°C	0.29N · m	–	R1	0	9.8N	PVC	Plastic	None	60	53 Page (53-B)
E32-T16PR 2M	-40 to 70°C	0.29N · m	–	R1	0	9.8N	PVC	Plastic	None	60	53 Page (53-A)
E32-T16WR 2M	-25 to 55°C	0.29N · m	–	R1	0	9.8N	PVC	Plastic	None	60	53 Page (53-D)
E32-T17L 10M	-40 to 70°C	0.78N · m	14.5 ⁺¹ ₀ dia.	R25	10	29.4N	Polyethylene	Plastic	None	240	29 Page (29-B)

*1 Unbendable length of cable from fiber head.

Do not bend the cable for at least 20 mm from where the cable inserts into the Fiber Amplifier Unit.

*2 For continuous operation, use the Fiber Unit between -40 to 90°C.

*3 The heat-resistant rating is not the same for all parts of the Fiber Unit. Refer to the dimensions diagrams for details.

*4 Ambient operating temperature of the recommended reflector (E39-RP1) is -40 to 60°C.

Models	Installation			Cable						Weight (packed state) (g)	Dimensions Page No.
	Ambient temperature	Tightening torque	Mounting hole	Bending radius	Unbendable length*1	Tensile strength	Sheath material	Core material	Emitter/receiver differentiation		
E32-T21 2M	-40 to 70°C	0.78N · m	3.2 ^{+0.5} ₀ dia. +2	R4	10	9.8N	PVC	Plastic	None	30	45 Page (45-B)
E32-T21-S1 2M	-40 to 70°C	0.78N · m	3.2 ^{+0.5} ₀ dia. +2	R10	10	9.8N	Polyethylene	Plastic	None	45	21 Page (21-D)
E32-T223R 2M	-40 to 70°C	0.20N · m	1.2 ^{+0.5} ₀ dia.	R1	20	9.8N	Polyethylene	Plastic	None	40	13 Page (13-A)
E32-T22B 2M	-40 to 70°C	0.20N · m	1.7 ^{+0.5} ₀ dia.	R4	10	9.8N	PVC	Plastic	None	40	13 Page (13-B) 45 Page (45-A)
E32-T22S 2M	-40 to 70°C	0.29N · m	3.2 ^{+0.5} ₀ dia.	R10	10	29.4N	PVC	Plastic	None	60	35 Page (35-F)
E32-T24E 2M	-40 to 70°C	0.29N · m	2.7 ^{+0.5} ₀ dia.	R10	10	9.8N	Polyethylene	Plastic	None	40	21 Page (21-B)
E32-T24R 2M	-40 to 70°C	0.29N · m	2.2 ^{+0.5} ₀ dia.	R1	0	9.8N	Polyethylene	Plastic	None	40	21 Page (21-A)
E32-T24S 2M	-40 to 70°C	0.29N · m	-	R10	10	29.4N	PVC	Plastic	None	60	35 Page (35-E) 61 Page (61-H)
E32-T24SR 2M	-40 to 70°C	0.29N · m	-	R1	0	9.8N	PVC	Plastic	None	60	35 Page (35-D) 61 Page (61-G)
E32-T25XB 2M	-40 to 70°C	0.15N · m	-	R4	10	9.8N	PVC	Plastic	None	40	45 Page (45-D)
E32-T25XR 2M	-40 to 70°C	0.15N · m	-	R1	0	9.8N	Polyethylene	Plastic	None	40	17 Page (17-B)
E32-T25YR 2M	-40 to 70°C	0.15N · m	-	R1	0	9.8N	Polyethylene	Plastic	None	40	17 Page (17-D)
E32-T25ZR 2M	-40 to 70°C	0.15N · m	-	R1	0	9.8N	Polyethylene	Plastic	None	40	17 Page (17-F)
E32-T33 1M	-40 to 70°C	0.29N · m	3.2 ^{+0.5} ₀ dia.	R10	10	9.8N	Polyethylene	Plastic	None	40	21 Page (21-C)
E32-T51 2M	-40 to 150°C *3	0.78N · m	4.2 ^{+0.5} ₀ dia.	R35	10	29.4N	Fluororesin	Plastic	None	70	49 Page (49-B)
E32-T51F 2M	-40 to 150°C *3	0.78N · m	5.5 ^{+0.5} ₀ dia.	R40	10	29.4N	Fluororesin	Plastic	None	220	43 Page (43-E)
E32-T51R 2M	-40 to 100°C *4	0.78N · m	4.2 ^{+0.5} ₀ dia.	R2	0	29.4N	Polyurethane	Plastic	None	60	49 Page (49-A)
E32-T51V 1M	-25 to 120°C	0.29N · m	4.2 ^{+0.5} ₀ dia.	R30	10	29.4N	Fluororesin	Glass	None	160	57 Page (57-A)
E32-T54 2M	-40 to 150°C *3	0.29N · m	-	R35	10	29.4N	Fluororesin	Plastic	None	160	49 Page (49-C)
E32-T61-S 2M	-60 to 350°C *5	0.78N · m	4.2 ^{+0.5} ₀ dia.	R25	10	29.4N	SUS	Glass	None	200	49 Page (49-G)
E32-T64-2 2M	-25 to 300°C *5	0.78N · m	-	R25	10	29.4N	SUS	Glass	None	70	49 Page (49-F)
E32-T81R-S 2M	-40 to 200°C *5	0.78N · m	4.2 ^{+0.5} ₀ dia.	R10	10	9.8N	Fluororesin	Glass	None	60	49 Page (49-D)
E32-T84SV 1M	-25 to 200°C	0.29N · m	4.5 ^{+0.5} ₀ dia.	R25	10	29.4N	SUS	Glass	None	190	57 Page (57-C)
E32-T84S-S 2M	-40 to 200°C *5	0.29N · m	-	R25	10	9.8N	SUS	Glass	None	-	49 Page (49-E)
E32-TC200BR 2M	-40 to 70°C	0.78N · m	4.2 ^{+0.5} ₀ dia.	R1	0	29.4N	PVC	Plastic	None	60	21 Page (21-E)
E32-VF1	-25 to 70°C	-	-	-	-	-	-	-	-	240	57 Page (57-F)
E32-VF4	-25 to 70°C	-	-	-	-	-	-	-	-	280	57 Page (57-E)
E39-F1	-40 to 200°C	-	-	-	-	-	-	-	-	2	30 Page (30-A) 31 Page (31-A) to (31-C) 32 Page (32-A) 33 Page (33-A) to (33-C)
E39-F1-33	-40 to 200°C	-	-	-	-	-	-	-	-	3	32 Page (32-D)
E39-F11	-	-	-	-	-	-	-	-	-	30	-
E39-F16	-40 to 350°C	-	-	-	-	-	-	-	-	15	30 Page (30-B) 31 Page (31-D) to (31-F) 32 Page (32-B) 33 Page (33-D) to (33-F), (33-K)
E39-F17	-25 to 70°C	-	-	-	-	-	-	-	-	10	25 Page (25-B)

*1 Unbendable length of cable from fiber head.
 Do not bend the cable for at least 20 mm from where the cable inserts into the Fiber Amplifier Unit.
 *2 For embedded mounting, prepare a hole with a diameter of 2.6 mm.
 *3 For continuous operation, use the Fiber Unit between -40 to 130°C.
 *4 For continuous operation, use the Fiber Unit between -40 to 90°C.
 *5 The heat-resistant rating is not the same for all parts of the Fiber Unit. Refer to the dimensions diagrams for details.

Threaded	Standard Installation
Hex-shaped	
Cylindrical	
Flat	Saving Space
Sleeved	
Small Spot	Beam Improvements
High Power	
Narrow view	
BGS	Transparent Objects
Retro-reflective	
Limited-reflective	
Chemical-resistant, Oil-resistant	Environmental Immunity
Bending	
Heat-resistant	
Area Detection	Applications
Liquid-level	
Vacuum	
FPD, Semi, Solar	

Threaded
Hex-shaped
CylindricalFlat
SleevedSmall Spot
High Power
Narrow
view
BGSRetro-
reflective
Limited-
reflectiveChemical-
resistant,
Oil-resistant
Bending
Heat-
resistantArea
Detection
Liquid-level
Vacuum
FPD,
Semi,
Solar

Models	Installation			Cable						Weight (packed state) (g)	Dimensions Page No.
	Ambient temperature	Tightening torque	Mounting hole	Bending radius	Unbendable length*1	Tensile strength	Sheath material	Core material	Emitter/receiver differentiation		
E39-F18	-40 to 70°C	-	-	-	-	-	-	-	-	5	27 Page 27-G , 27-H
E39-F1V	-25 to 120°C	-	-	-	-	-	-	-	-	3	57 Page 57-B
E39-F2	-40 to 200°C	-	-	-	-	-	-	-	-	2	30 Page 30-C 31 Page 31-G , 31-H 32 Page 32-C 33 Page 33-G to 33-I
E39-F32A 1M	-40 to 150°C	-	-	R30	-	-	-	-	-	70	47 Page 47-G
E39-F32C 1M	-40 to 150°C	-	-	R30	-	-	-	-	-	110	45 Page 45-E 47 Page 47-G
E39-F32D 1M	-40 to 150°C	-	-	R30	-	-	-	-	-	80	47 Page 47-G
E39-F3A	-40 to 70°C	-	-	-	-	-	-	-	-	2	25 Page 25-A
E39-F3A-5	-40 to 70°C	-	-	-	-	-	-	-	-	1	27 Page 27-A , 27-B , 27-C
E39-F3B	-25 to 55°C	-	-	-	-	-	-	-	-	2	27 Page 27-D , 27-E , 27-F
E39-F3C	-25 to 55°C	-	-	-	-	-	-	-	-	1	25 Page 25-C , 25-D
E39-R1	-25 to 55°C	-	-	-	-	-	-	-	-	20	39 Page 39-B
E39-R3	-25 to 55°C	-	-	-	-	-	-	-	-	20	39 Page 39-C
E39-RP1	-40 to 60°C	-	-	-	-	-	-	-	-	25	39 Page 39-A 11 Page 11-G
E39-RP37	-25 to 55°C	-	-	-	-	-	-	-	-	4	-
E39-RSP1	-25 to 55°C	-	-	-	-	-	-	-	-	4	-

*1 Unbendable length of cable from fiber head.

Do not bend the cable for at least 20 mm from where the cable inserts into the Fiber Amplifier Unit.

MEMO

Fiber Sensor Features

Selection Guide

Fiber Units

Threaded	Standard Installation
Hex-shaped	
Cylindrical	
Flat	Saving Space
Sleeved	
Small Spot	Beam Improvements
High Power	
Narrow view	
BGS	Transparent Objects
Retro-reflective	
Limited-reflective	Environmental Immunity
Chemical-resistant, Oil-resistant	
Bending	
Heat-resistant	Applications
Area Detection	
Liquid-level	
Vacuum	Applications
FPD, Semi, Solar	

Installation Information

Fiber Amplifiers, Communications Unit, and Accessories

Technical Guide and Precautions

Model Index

- Threaded
- Hex-shaped
- Cylindrical

- Flat
- Sleeved

- Small Spot
- High Power
- Narrow view
- BGS

- Retro-reflective
- Limited-reflective

- Chemical-resistant, Oil-resistant
- Bending
- Heat-resistant

- Area Detection
- Liquid-level
- Vacuum
- FPD, Semi, Solar

Smart Fiber Amplifier Units

E3NX-FA Series

A Smart Fiber Amplifier Unit with Ultra-stable Detection and Ultra-easy Setup



70 Page

Expanded Application Response Capabilities Advanced Basic Performance

Improvements in the sensing distance and minimum sensing object have increased the range of application for stable detection.

1.5 Times the Sensing Distance*

6 m

For E32-LT11 Fiber Unit with a fiber length of 3.5 m

1/10th the Minimum Sensing Object*

0.3 μm dia.

Typical example of actual measurements with E32-D11R Fiber Unit.

*Compared to E3X-ZV.

Achieve Easy Detection in Many Applications Advanced Smart Tuning

Just press the **TUNE** button once with a workpiece and once without a workpiece to automatically set the optimum incident level and threshold. Consistent settings are achieved for all users with this ultra-easy procedure.



Press the **TUNE** button **once** with a workpiece and **once** without a workpiece

Automatic Setting of Optimum Values

Threshold + Incident Level

5000 9999

Set to the intermediate value between the incident levels with and without a workpiece.

Optimum Light Intensity Adjustment from Transparent Objects to Black Workpieces

The incident level is optimized to enable stable detection even for saturated or insufficient incident levels.

Light Intensity Adjustment Range of 40,000 Times



Excessive Incident Level
▶ Incident light reduced.

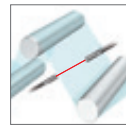

▶ Incident light increased.



Sensor Communications Units for E3NX-FA

E3NW Series

The Next-generation E3NW Sensor Network Units Revolutionize On-site Sensing

The Sensor Communications Unit with a master function and the Distributed Sensor Units with slave functions enable N-Smart Sensors communication over open networks.



70 Page

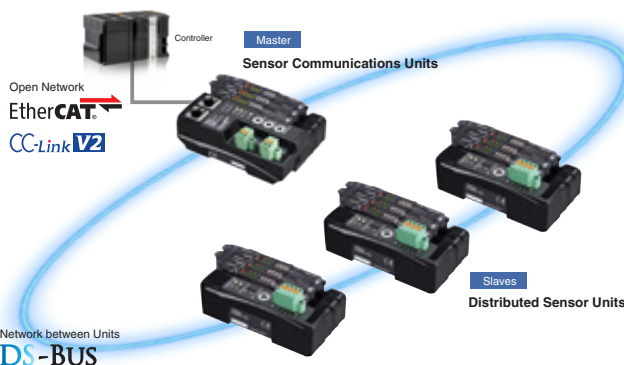

Greatly Reduced Machine Manufacturing Costs

There is no need to change the current distributed installation to introduce a network without increasing costs.

Greatly Reduced Machine Commissioning Time

All of the settings can be made at the same time from a Touch Panel.

Greatly Improved Machine Productivity

Realtime monitoring lets you perform maintenance before malfunctions occur.

Smart Fiber Amplifier Units

E3X-ZV Series

Affordable Amplifier Units with Simple Operation and Stable Detection Capabilities



86
Page

2-channel model option to attain the ultimate cost reduction

The 2-channel model equipped with amplifier functions for two fiber amplifier units enables substantial purchase cost reduction since the required number of units is halved. Furthermore, it greatly contributes to the downsizing of equipment and control panel in addition to allowing substantial reduction in wiring workload and power consumption.

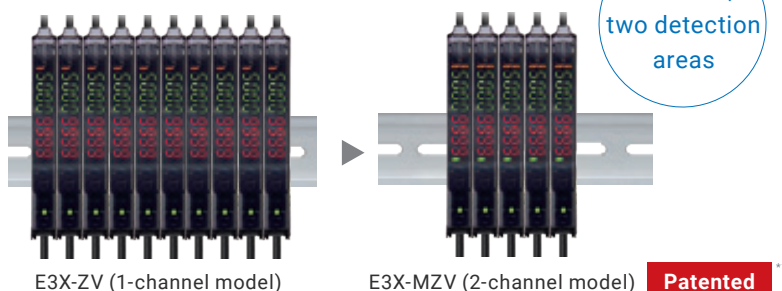

Note: Refer to E3X-ZV/MZV Catalog (Cat. No. E600).
*1. "Patent pending or Patented" indication means patent is pending or is patented in Japan. (As of February 2021.)

<Fiber Amplifier Unit Comparison>

		E3X-ZV Series	E3NX-FA Series
Fiber Amplifier Unit specifications	Output	1 output	1 or 2 outputs (depending on the model)
	External input	Not supported	Supported or not supported (depending on the model)
	Response time	50 μs /250 μs/1 ms/16 ms (Default: 250 μs)	30 μs (32 μs)/250 μs/1 ms/16 ms (Default: 250 μs)
	Sensing distance (Giga-power mode)	E32-T11R	2,000 mm
E32-D11R		840 mm	1,260 mm
	Minimum sensing object	E32-T11R 5 μm dia.	2 μm dia.
Sensor Communications Unit application	Communications method (Sensor Communications Unit model)	—	EtherCAT (E3NW-ECT) CC-Link (E3NW-CCL)
	Applicable Sensors	—	Fiber Sensor (E3NX-FA0/FA10/FA40/FAH0) Laser Sensors (E3NC-LA0, E3NC-SA0) Contact-Type Sensor (E9NC-TA0)*
Page listings	Ordering Information	86 Page	70 Page
	Ratings and Specifications	88 Page	72 Page
	Dimensions	89 Page	76 Page

Note. The sensing distances for the E3NX-FA are values for E3NX-FA□ devices. The distance for E3NX-FAH□ infrared models varies.

Fiber Amplifier Unit Accessories

71, 87
Page

Fiber Sensor Features

Selection Guide

Fiber Units

Threaded
Hex-shaped
Cylindrical

Standard Installation

Flat
Sleeved

Saving Space

Small Spot
High Power
Narrow view
BGS

Beam Improvements

Retro-reflective
Limited-reflective

Transparent Objects

Chemical-resistant, Oil-resistant
Bending
Heat-resistant

Environmental Immunity

Area Detection
Liquid-level
Vacuum

Applications

Installation Information

Fiber Amplifiers, Communications Unit, and Accessories

Technical Guide and Precautions

Model Index

Threaded
Hex-shaped
CylindricalFlat
SleevedSmall Spot
High Power
Narrow viewBGS
Retro-reflective
Limited-reflectiveChemical-resistant,
Oil-resistant
Bending
Heat-resistantArea Detection
Liquid-level
Vacuum

E3NX-FA Fiber Amplifier Units and Related Products

Fiber Amplifier Units E3NX-FA Series

Type	Appearance	Connecting method	Inputs/ outputs	Models		Ratings and Specifications	Dimensions
				NPN output	PNP output		
Standard models		Pre-wired (2 m)	1 output	E3NX-FA11 2M	E3NX-FA41 2M	Page 76 (76-A)	Page 76 (76-A)
		Wire-saving Connector	1 output	E3NX-FA11-5 2M *1	—		
Advanced models		Pre-wired (2 m)	2 outputs + 1 input	E3NX-FA21 2M	E3NX-FA51 2M	Page 72 Page 76 (76-A) Page 76 (76-B) Page 77 (77-A)	Page 76 (76-A) Page 76 (76-B) Page 77 (77-A)
		Wire-saving Connector	1 output + 1 input	E3NX-FA7	E3NX-FA9		
			2 outputs	E3NX-FA7TW	E3NX-FA9TW		
		M8 Connector	1 output + 1 input	E3NX-FA24	E3NX-FA54		
Infrared models		Pre-wired (2 m)	1 output	E3NX-FAH11 2M	E3NX-FAH41 2M	Page 76 (76-A) Page 76 (76-B)	Page 76 (76-A) Page 76 (76-B)
		Wire-saving Connector	1 output	E3NX-FAH6	E3NX-FAH8		
Analog output models		Pre-wired (2 m)	2 output	E3NX-FA11AN 2M	E3NX-FA41AN 2M	Page 76 (76-A)	Page 76 (76-A)
Model for Sensor Communications Unit *2		Connector for Sensor Communications Unit	—	E3NX-FA0		Page 74	Page 77 (77-B)
		Connector for Sensor Communications Unit Pre-wired (2 m)	1 output	E3NX-FA10 2M	E3NX-FA40 2M		



*1. This type can prevent mutual interference for two units in the SHS2 mode.

*2. A Sensor Communications Unit is required if you want to use the Fiber Amplifier Unit on a network.

Note. The sensing distances for E3NX-FA in this catalog are values for E3NX-FA□ models. The distances for E3NX-FAH□ infrared models are different.

Sensor Communications Unit

Sensor Communications Unit

Communication method	Appearance	Applicable Fiber Amplifier Model	Model	Ratings and Specifications	Dimensions
EtherCAT		E3NX-FA0 E3NX-FA10 E3NX-FA40 E3NX-FAH0	E3NW-ECT	Page 84	Page 85 (85-A)
CC-Link			E3NW-CCL	*1	*1

*1. For details, refer to your OMRON website.

Distributed Sensor Unit

Appearance	Applicable Fiber Amplifier Model	Model	Ratings and Specifications	Dimensions
	E3NX-FA0	E3NW-DS	Page 84	Page 85 85-B

Note. The Distributed Sensor Unit can be connected to any of the Sensor Communications Units.

Use the following DS-Bus communication cable (recommended) when connecting a sensor communications unit and a distributed sensor unit.

Item	Manufacturer	Model
Communication cable	BANDO DENSEN Co., Ltd.	ESVC 0.5X2C, black

Connector cover for Sensor Communications Unit and Distributed Sensor Unit (provided)





Order a Cover when required, e.g., if you lose the covers.

Model
E39-G27

Accessories (sold separately)

Wire-saving connectors (Required for models for Wire-saving Connectors.)

Connectors are not provided with the Fiber Amplifier Unit and must be ordered separately. * Protective stickers: provided.

Type	Appearance	Cable length	Number of conductors	Applicable Fiber Amplifier Units	Models	Ratings, Specifications and Dimensions
Master Connector		2 m	4	E3NX-FA7 E3NX-FA7TW	E3X-CN21	Page 94 94-A
Slave Connector			2	E3NX-FA9 E3NX-FA9TW	E3X-CN22	Page 94 94-B
Master Connector			3	E3NX-FA6 E3NX-FA8	E3X-CN11	Page 94 94-A
Slave Connector			1	E3NX-FAH6 E3NX-FAH8	E3X-CN12	Page 94 94-B

Sensor I/O Connectors (Required for models with M8 Connectors.)

Connectors are not provided with the Fiber Amplifier Unit and must be ordered separately. * Protective stickers: provided.

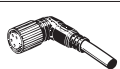
Appearance	Cable length	Number of conductors	Models	Ratings and Specifications	Dimensions
	2 m	4	XS3F-M421-402-A	Page 94	Page 94 94-C
	5 m		XS3F-M421-405-A		
	2 m		XS3F-M422-402-A		Page 94 94-D
	5 m		XS3F-M422-405-A		

Mounting Bracket

A Mounting Bracket is not provided with the Fiber Amplifier Unit and must be ordered separately as required.

Appearance	Model	Quantity	Dimensions
	E39-L143	1	Page 95 95-A

DIN Track

A Din Track is not provided with the Fiber Amplifier Unit and must be ordered separately as required.

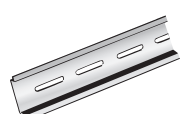
Appearance	Type	Models	Quantity	Dimensions
	Shallow type, total length: 1 m	PFP-100N	1	Page 95 95-B
	Shallow type, total length: 0.5 m	PFP-50N		
	Deep type, total length: 1 m	PFP-100N2		Page 95 95-C

End Plate

Two End Plates are provided with the Sensor Communications Unit. End Plates are not provided with the Fiber Amplifier Unit and must be ordered separately as required.

Appearance	Model	Quantity	Dimensions
	PFP-M	1	Page 95 95-D

Cover

Attach these Covers to Amplifier Units.

Order a Cover when required, e.g., if you lose the covers.

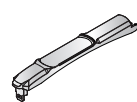
Appearance	Model	Quantity
	E39-G25 FOR E3NX-FA	1

Ratings and Specifications

Standard models/ Advanced models/ Infrared models

Item	Type	Standard models			Advanced models					Infrared models	
	NPN output	E3NX-FA11	E3NX-FA6	E3NX-FA11-5 *1	E3NX-FA21	E3NX-FA7	E3NX-FA7TW	E3NX-FA24	—	E3NX-FAH11	E3NX-FAH6
	PNP output	E3NX-FA41	E3NX-FA8	—	E3NX-FA51	E3NX-FA9	E3NX-FA9TW	E3NX-FA54	E3NX-FA54TW	E3NX-FAH41	E3NX-FAH8
Inputs/ outputs	Connecting method	Pre-wired	Wire-saving Connector	Pre-wired	Pre-wired	Wire-saving Connector	M8 Connector		Pre-wired	Wire-saving Connector	
	Outputs	1 output			2 outputs	1 output	2 outputs	1 output	2 outputs	1 outputs	
Light source (wavelength)	External inputs	—			1 input	1 input	—	1 input	—	—	
	Power supply voltage	Red, 4-element LED (625 nm)									
Power consumption *2	Power supply voltage	10 to 30 VDC, including 10% ripple (p-p)									
	Power consumption	At Power supply voltage of 24 VDC Standard Models: Normal mode : 840 mW max. (Current consumption at 35 mA max.) Eco function ON : 650 mW max. (Current consumption at 27 mA max.) Eco function LO : 750 mW max. (Current consumption at 31 mA max.) Advanced Models or Model for Sensor Communications Unit: Normal mode : 920 mW max. (Current consumption at 38 mA max.) Eco function ON : 680 mW max. (Current consumption at 28 mA max.) Eco function LO : 800 mW max. (Current consumption at 33 mA max.) Infrared models: Normal mode : 1,080 mW max. (Current consumption at 45 mA max.) Eco function ON : 920 mW max. (Current consumption at 38 mA max.) Eco function LO : 1020 mW max. (Current consumption at 42 mA max.)									
Control output	Control output	Load power supply voltage: 30 VDC max., open-collector output (depends on the NPN/PNP output format) Load current: Groups of 1 to 3 Amplifier Units: 100 mA max., Groups of 4 to 30 Amplifier Units: 20 mA max. (Residual voltage: At load current of less than 10 mA: 1 V max., At load current of 10 to 100 mA: 2 V max.) OFF current: 0.1 mA max.									
	External inputs	—			Refer to *3.		—		Refer to *3.		—
Indicators	Indicators	7-segment displays (Sub digital display: green, Main digital display: white) Display direction: Switchable between normal and reversed. OUT indicator (orange), L/D indicator (orange), ST indicator (blue), DPC indicator (green), and OUT selection indicator (orange, only on models with 2 outputs)									
	Protection circuits	Power supply reverse polarity protection, output short-circuit protection, and output reverse polarity protection									
Response time	Super-high-speed mode (SHS)	Operate or reset for model with 1 output: 30 ms (Super High Speed mode (SHS2) of E3NX-FA11-5 is 60 ms each), with 2 outputs: 32 ms									
	High-speed mode (HS)	Operate or reset: 250 ms									
	Standard mode (Std)	Operate or reset: 1 ms									
	Giga-power mode (GIGA)	Operate or reset: 16 ms									
Sensitivity adjustment	Sensitivity adjustment	Smart Tuning (2-point tuning, full auto tuning, position tuning, maximum sensitivity tuning, power tuning, or percentage tuning (-99% to 99%)) or manual adjustment									
Maximum connectable Units	Maximum connectable Units	30									
No. of Units for mutual interference prevention *4	Super-high-speed mode (SHS)	0									
	High-speed mode (HS)	10									
	Standard mode (Std)	10									
	Giga-power mode (GIGA)	10									

*1. This type can prevent mutual interference for two units in the SHS2 mode.

*2. At Power supply voltage of 10 to 30 VDC

Standard Models:

Normal mode : 990 mW max. (Current consumption: 33 mA max. at 30 VDC, 65 mA max. at 10 VDC)

Eco function ON: 780 mW max. (Current consumption: 26 mA max. at 30 VDC, 42 mA max. at 10 VDC)

Eco function LO : 840 mW max. (Current consumption: 28 mA max. at 30 VDC, 45 mA max. at 10 VDC)

Advanced Models:

Normal mode : 1,020 mW max. (Current consumption: 34 mA max. at 30 VDC, 67 mA max. at 10 VDC)

Eco function ON: 810 mW max. (Current consumption: 27 mA max. at 30 VDC, 44 mA max. at 10 VDC)

Eco function LO : 870 mW max. (Current consumption: 29 mA max. at 30 VDC, 48 mA max. at 10 VDC)

Infrared models:

Normal mode : 1,260 mW max. (Current consumption: 42 mA max. at 30 VDC, 80 mA max. at 10 VDC)

Eco function ON: 1,050 mW max. (Current consumption: 35 mA max. at 30 VDC, 60 mA max. at 10 VDC)

Eco function LO : 1,140 mW max. (Current consumption: 38 mA max. at 30 VDC, 70 mA max. at 10 VDC)

*3. The following details apply to the input.

	Contact input (relay or switch)	Non-contact input (transistor)	Input time *3-1
NPN	ON: Shorted to 0 V (Sourcing current: 1 mA max.) OFF: Open or shorted to Vcc.	ON: 1.5 V max. (Sourcing current: 1 mA max.) OFF: Vcc - 1.5 V to Vcc (Leakage current: 0.1 mA max.)	ON: 9 ms min. OFF: 20 ms min.
PNP	ON: Shorted to Vcc (Sinking current: 3 mA max.) OFF: Open or shorted to 0 V.	ON: Vcc - 1.5 V to Vcc (Sinking current: 3 mA max.) OFF: 1.5 V max. (Leakage current: 0.1 mA max.)	

*3-1. Input time is 25 ms (ON)/(OFF) only when (in tUnE) or (in PtUn) input is selected.

*4. When the Super High Speed mode (SHS) is set, mutual interference prevention is disabled (2 units for E3NX-FA11-5).

Threaded
Hex-shaped
Cylindrical

Flat
Sleeved

Small Spot
High Power
Narrow view
BGS

Retro-reflective
Limited-reflective

Chemical-resistant,
Oil-resistant
Bending
Heat-resistant

Area Detection
Liquid-level
Vacuum

Item	Type	Standard models			Advanced models					Infrared models	
	NPN output	E3NX-FA11	E3NX-FA6	E3NX-FA11-5 *1	E3NX-FA21	E3NX-FA7	E3NX-FA7TW	E3NX-FA24	—	E3NX-FAH11	E3NX-FAH6
	PNP output	E3NX-FA41	E3NX-FA8	—	E3NX-FA51	E3NX-FA9	E3NX-FA9TW	E3NX-FA54	E3NX-FA54TW	E3NX-FAH41	E3NX-FAH8
Connecting method	Pre-wired	Wire-saving Connector	Pre-wired	Pre-wired	Wire-saving Connector	M8 Connector		Pre-wired	Wire-saving Connector		
	Functions	Automatic power control (APC)	Always enabled.								
Dynamic power control (DPC)		Provided									
Timer		Select from timer disabled, OFF-delay, ON-delay, one-shot, or ON-delay + OFF-delay timer: 1 to 9,999 ms									
Zero reset		Negative values can be displayed. (Threshold value is shifted.)									
Resetting settings *5		Select from initial reset (factory defaults) or user reset (saved settings).									
Eco mode *6		Select from OFF (digital display lit), Eco ON (digital display not lit), and Eco LO (digital display dimmed).									
Bank switching		Select from banks 1 to 4.									
Power tuning		Select from ON, OFF or Execution on power-up.								Select from ON or OFF.	
Output 1		Select from normal detection mode, area detection mode or differential detection mode.								Select from normal detection mode or area detection mode.	
Output 2		—		Select from normal detection mode, alarm output mode, error output mode or differential detection mode.	—	Select from normal detection mode, alarm output mode, error output mode or differential detection mode.	—	Select from normal detection mode, alarm output mode, error output mode or differential detection mode.	—		
External input		—		Select from input OFF, tuning, power tuning, emission OFF, Sensor OFF, zero reset, or bank switching.	—	Select from input OFF, tuning, power tuning, emission OFF, Sensor OFF, zero reset, or bank switching.	—	Select from input OFF, tuning, power tuning, emission OFF, Sensor OFF, zero reset, or bank switching.	—		
Hysteresis width		Select from standard setting or user setting. For a user setting, the hysteresis width can be set from 0 to 9,999.									
Ambient illumination (Receiver side)	Incandescent lamp: 20,000 lx max., Sunlight: 30,000 lx max.										
Ambient temperature range *7	Operating: Groups of 1 or 2 Amplifier Units: -25 to 55°C, Groups of 3 to 10 Amplifier Units: -25 to 50°C, Groups of 11 to 16 Amplifier Units: -25 to 45°C, Groups of 17 to 30 Amplifier Units: -25 to 40°C Storage: -30 to 70°C (with no icing or condensation)										
Ambient humidity range	Operating and storage: 35 to 85% (with no condensation) within the surrounding air temperature range shown above										
Altitude	2,000 m max.										
Installation environment	Pollution degree 3										
Insulation resistance	20 MW min. (at 500 VDC)										
Dielectric strength	1,000 VAC at 50/60 Hz for 1 min										
Vibration resistance (destruction)	10 to 55 Hz with a 1.5-mm double amplitude for 2 hours each in X, Y, and Z directions										
Shock resistance (destruction)	500 m/s ² for 3 times each in X, Y, and Z directions										
Weight (packed state/Sensor only)	Approx. 115 g/ approx. 75 g	Approx. 60g/ approx. 20g	Approx. 115 g/ approx. 75 g	Approx. 115 g/ approx. 75 g	Approx. 60g/approx. 20g	Approx. 65 g/approx. 25 g	Approx. 115 g/ approx. 75 g	Approx. 60g/ approx. 20g			
Materials	Case	Polycarbonate (PC)									
	Cover	Polycarbonate (PC)									
	Cable	PVC									
Accessories	Instruction Manual										

*5. The bank is not reset by the user reset function or saved by the user save function.

*6. Eco LO is supported for Amplifier Units manufactured in July 2014 or later.

*7. When the number of connected units is 11 or more, the ambient temperature is less than 50°C.

Threaded	Standard Installation
Hex-shaped	
Cylindrical	
Flat	Saving Space
Sleeved	
Small Spot	Beam Improvements
High Power	
Narrow view	
BGS	Transparent Objects
Retro-reflective	
Limited-reflective	
Chemical-resistant, Oil-resistant	Environmental Immunity
Bending	
Heat-resistant	
Area Detection	Applications
Liquid-level	
Vacuum	
FPD, Semi, Solar	

Threaded
Hex-shaped
CylindricalFlat
SleevedSmall Spot
High Power
Narrow view
BGSRetro-reflective
Limited-reflectiveChemical-resistant,
Oil-resistant
Bending
Heat-resistantArea Detection
Liquid-level
Vacuum
FPD,
Semi,
Solar

Analog output models/ Model for Sensor Communications Unit

Item	Type	Analog output models		Model for Sensor Communications Unit	
	NPN output	E3NX-FA11AN	E3NX-FA10	E3NX-FA0	E3NX-FAH0
	PNP output	E3NX-FA41AN	E3NX-FA40		
Connecting method	Pre-wired	Connector for Sensor Communications Unit Pre-wired	Connector for Sensor Communications Unit		
Inputs/ outputs	Outputs	2 outputs	1 output	—*1	
	External inputs	—	—		
Light source (wavelength)	Red, 4-element LED (625 nm)			Infrared LED (870nm)	
Power supply voltage	10 to 30 VDC, including 10% ripple (p-p)		Supplied from the connector through the communication units.		
Power consumption *2	At Power supply voltage of 24 VDC Normal mode : 960 mW max. (Current consumption at 40 mA max.) Eco function ON: 770 mW max. (Current consumption at 32 mA max.) Eco function LO : 870 mW max. (Current consumption at 36 mA max.)		At Power supply voltage of 24 VDC Normal mode : 920 mW max. (Current consumption at 38 mA max.) Eco function ON: 680 mW max. (Current consumption at 26 mA max.) Eco function LO : 800 mW max. (Current consumption at 33 mA max.)		At Power supply voltage of 24 VDC Normal mode : 1,080 mW max. (Current consumption at 45 mA max.) Eco function ON: 920 mW max. (Current consumption at 38 mA max.) Eco function LO : 1,020 mW max. (Current consumption at 42 mA max.)
Control output	Load power supply voltage: 30 VDC max., open-collector output (depends on the NPN/PNP output format) Load current: Groups of 1 to 3 Amplifier Units: 100 mA max., Groups of 4 to 30 Amplifier Units: 20 mA max. (Residual voltage: At load current of less than 10 mA: 1 V max. At load current of 10 to 100 mA: 2 V max.) OFF current: 0.1 mA max.			—	
Analog output (reference value)	Voltage output: 1-5 VDC (10 kW or more connected load), temperature characteristics: 0.3% F.S. / °C		—		
Indicators	7-segment displays (Sub digital display: green, Main digital display: white) Display direction: Switchable between normal and reversed. OUT indicator (orange), L/D indicator (orange), ST indicator (blue), DPC indicator (green), and OUT selection indicator (orange, only on models with 2 outputs)				
Protection circuits	Power supply reverse polarity protection, output short-circuit protection, and output reverse polarity protection			Power supply reverse polarity protection and output short-circuit protection	
Control output Response time	Super-high-speed mode (SHS)	Operate or reset: 80 ms	Operate or reset: 32 ms		
	High-speed mode (HS)	Operate or reset: 250ms	Operate or reset: 250 ms		
	Standard mode (Std)	Operate or reset: 1 ms	Operate or reset: 1 ms		
	Giga-power mode (GIGA)	Operate or reset: 16 ms	Operate or reset: 16 ms		
Sensitivity adjustment	Smart Tuning (2-point tuning, full auto tuning, position tuning, maximum sensitivity tuning, power tuning, percentage tuning (-99% to 99%)) or manual adjustment				
Maximum connectable Units	30	16	With E3NW-ECT: 30 units (When connected to an OMRON NJ-series Controller.) With E3NW-CRT: 16 units (Note: E3NX-FAH0 can not be connected.) With E3NW-CCL: 16 units		
No. of Units for mutual interference prevention *3	Super-high-speed mode (SHS)	0 (The mutual interference prevention function is disabled if the detection mode is set to super-high-speed mode.)			
	High-speed mode (HS)	10			
	Standard mode (Std)	10			
	Giga-power mode (GIGA)	10			

*1. Two sensor outputs are allocated in the programmable logic controller PLC I/O table.

PLC operation via Communications Unit enables reading detected values and changing settings.

*2. At Power supply voltage of 10 to 30 VDC

Analog output models:

Normal mode : 1,080 mW max. (Current consumption: 36 mA max. at 30 VDC, 75 mA max. at 10 VDC)

Eco function ON: 840 mW max. (Current consumption: 28 mA max. at 30 VDC, 55 mA max. at 10 VDC)

Eco function LO : 960 mW max. (Current consumption: 32 mA max. at 30 VDC, 65 mA max. at 10 VDC)

*3. The tuning will not change the number of units.

The least unit count among the mutual interference prevention units of E3NX and E3NC.

Check the mutual interference prevention unit count and response speed of each model.

Item	Type	Model for Sensor Communications Unit		
	NPN output	E3NX-FA11AN	E3NX-FA10	E3NX-FA0
	PNP output	E3NX-FA41AN	E3NX-FA40	
Connecting method	Pre-wired	Connector for Sensor Communications Unit Pre-wired	Connector for Sensor Communications Unit	
Functions	Automatic power control (APC)	Always enabled.		
	Dynamic power control (DPC)	Provided		
	Timer	Select from timer disabled, OFF-delay, ON-delay, one-shot, or ON-delay + OFF-delay timer: 1 to 9,999 ms		
	Zero reset	Negative values can be displayed. (Threshold value is shifted.)		
	Resetting settings ^{*4}	Select from initial reset (factory defaults) or user reset (saved settings).		
	Eco mode	Select from OFF (digital display lit), Eco ON (digital display not lit), and Eco LO (digital display dimmed).		
	Bank switching	Select from banks 1 to 4.		
	Sensor OFF setting	—	Select from ON or OFF.	—
	Power tuning	Select from ON or OFF.		
	Output 1	Select from normal detection mode, area detection mode or differential detection mode (E3NX-FA10/40 only).		
	Output 2	Select from Analog scaling or Analog offset.	—	Select from normal detection mode, alarm output mode, error output mode or differential detection mode (E3NX-FA0 only).
Hysteresis width	Select from standard setting or user setting. For a user setting, the hysteresis width can be set from 0 to 9,999.			
Ambient illumination (Receiver side)	Incandescent lamp: 20,000 lx max., Sunlight: 30,000 lx max.			
Ambient temperature range ^{*5}	Operating: Groups of 1 or 2 Amplifier Units: -25 to 55°C, Groups of 3 to 10 Amplifier Units: -25 to 50°C, Groups of 11 to 16 Amplifier Units: -25 to 45°C, Groups of 17 to 30 Amplifier Units: -25 to 40°C Storage: -30 to 70°C (with no icing or condensation)	Operating: Groups of 1 or 2 Amplifier Units: 0 to 55°C, Groups of 3 to 10 Amplifier Units: 0 to 50°C, Groups of 11 to 16 Amplifier Units: 0 to 45°C Storage: -30 to 70°C (with no icing or condensation)	Operating: Groups of 1 or 2 Amplifier Units: 0 to 55°C, Groups of 3 to 10 Amplifier Units: 0 to 50°C, Groups of 11 to 16 Amplifier Units: 0 to 45°C, Groups of 17 to 30 Amplifier Units: 0 to 40°C Storage: -30 to 70°C (with no icing or condensation)	
Ambient humidity range	Operating and storage: 35 to 85% (with no condensation) within the surrounding air temperature range shown above			
Altitude	2,000 m max.			
Installation environment	Pollution degree 3			
Insulation resistance	20 MW min. (at 500 VDC)			
Dielectric strength	1,000 VAC at 50/60 Hz for 1 min			
Vibration resistance (destruction)	10 to 55 Hz with a 1.5-mm double amplitude for 2 hours each in X, Y, and Z directions			
Shock resistance (destruction)	500 m/s ² for 3 times each in X, Y, and Z directions	150 m/s ² for 3 times each in X, Y, and Z directions		
Weight (packed state/Sensor only)	Approx. 115 g/approx. 75 g	Approx. 95 g/approx. 45 g	Approx. 65 g/approx. 25 g	Approx. 65 g/approx. 25 g
Materials	Case	Polycarbonate (PC)		
	Cover	Polycarbonate (PC)		
	Cable	PVC		
Accessories	Instruction Manual			

*4. The bank is not reset by the user reset function or saved by the user save function.

*5. When the number of connected units is 11 or more, the ambient temperature is less than 50°C.

Threaded	Standard Installation
Hex-shaped	
Cylindrical	

Flat	Saving Space
Sleeved	

Small Spot	Beam Improvements
High Power	
Narrow view	

BGS	Transparent Objects
Retro-reflective	
Limited-reflective	

Chemical-resistant, Oil-resistant	Environmental Immunity
Bending	
Heat-resistant	

Area Detection	Applications
Liquid-level	
Vacuum	
FPD, Semi, Solar	

Dimensions

Tolerance class IT16 applies to demmensions in this date sheet unless otherwise specified.

(Unit: mm)

Pre-wired Amplifier Units

- 76-A E3NX-FA□1(-5)
- E3NX-FAH□1
- E3NX-FA□AN

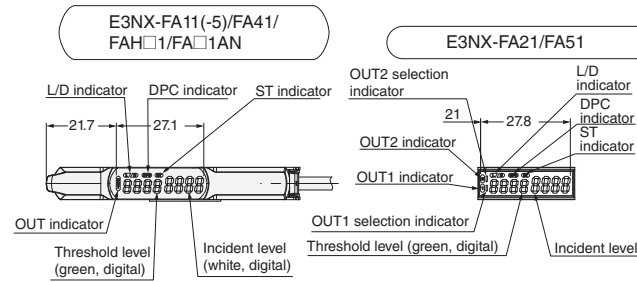

*Cable Specifications

Model	Outer diameter	No. of conductors	Others
E3NX-FA11(-5)	4.0 dia.	3	Conductor cross-section: 0.2 mm ² Insulator dia.: 0.9 mm Standard cable length: 2 m
E3NX-FA41			
E3NX-FAH□1			
E3NX-FA□1AN	4.0 dia.	4	Minimum bending radius: 12 mm
E3NX-FA21			
E3NX-FA51	4.0 dia.	5	

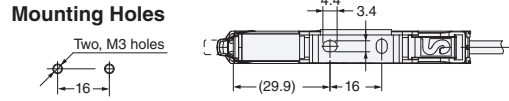
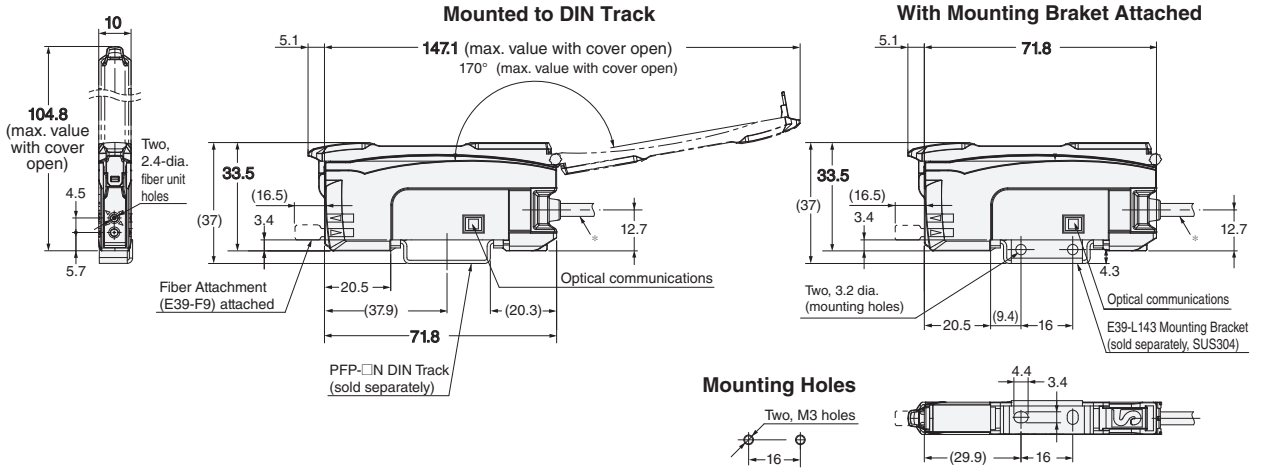

Amplifier Units with Wire-saving Connectors

- 76-B E3NX-FA6
- E3NX-FA7(TW)
- E3NX-FA8
- E3NX-FA9(TW)
- E3NX-FAH6
- E3NX-FAH8

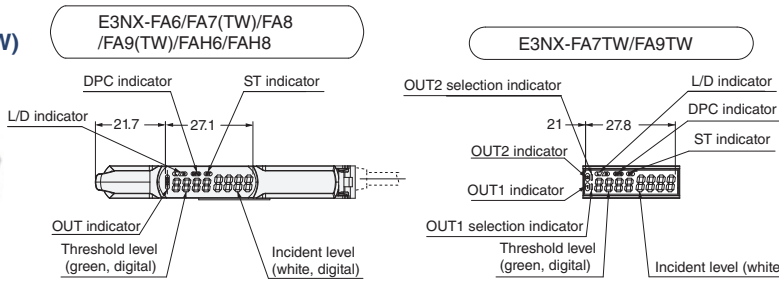

*Cable Specifications

Model	Outer diameter	No. of conductors
E3X-CN12	2.6 dia.	1
E3X-CN22	4.0 dia.	2
E3X-CN11		3
E3X-CN21		4

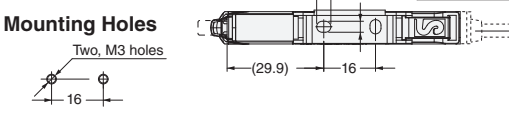
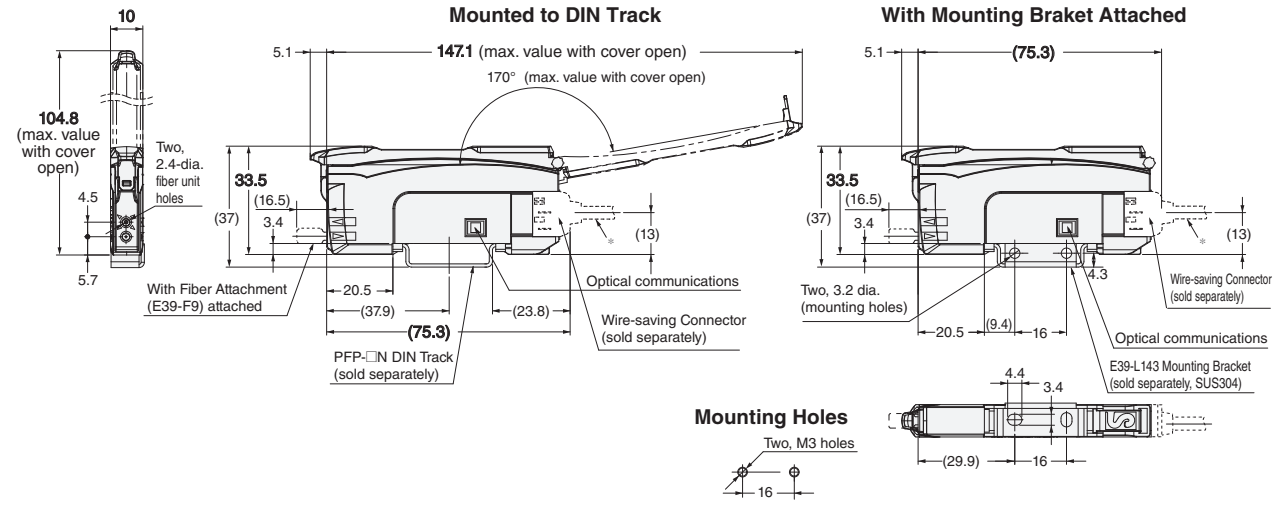

Threaded	Standard Installation
Hex-shaped	
Cylindrical	
Flat	Saving Space
Sleeved	
Small Spot	Beam Improvements
High Power	
Narrow view	
BGS	Transparent Objects
Retro-reflective	
Limited-reflective	
Chemical-resistant, Oil-resistant	Environmental Immunity
Bending	
Heat-resistant	
Area Detection	Applications
Liquid-level	
Vacuum	
FPD, Semi, Solar	Installation Information

Amplifier Units with M8 Connector

- 77-A E3NX-FA24
- E3NX-FA54
- E3NX-FA54TW

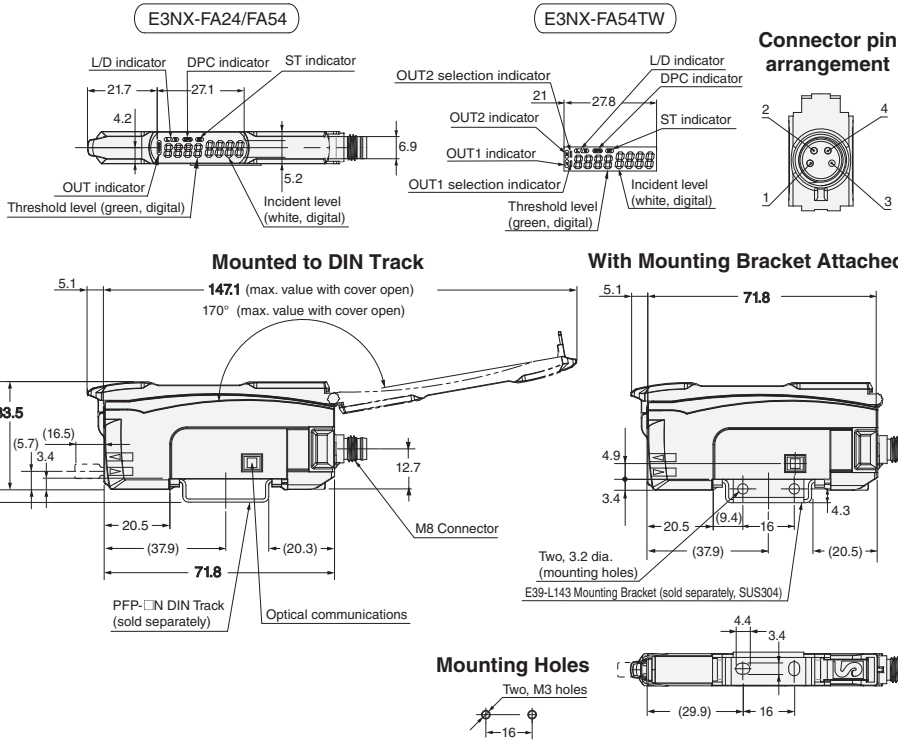

Amplifier Unit with Connector for Sensor Communications Unit

- 77-B E3NX-FA0/FA10/FA40

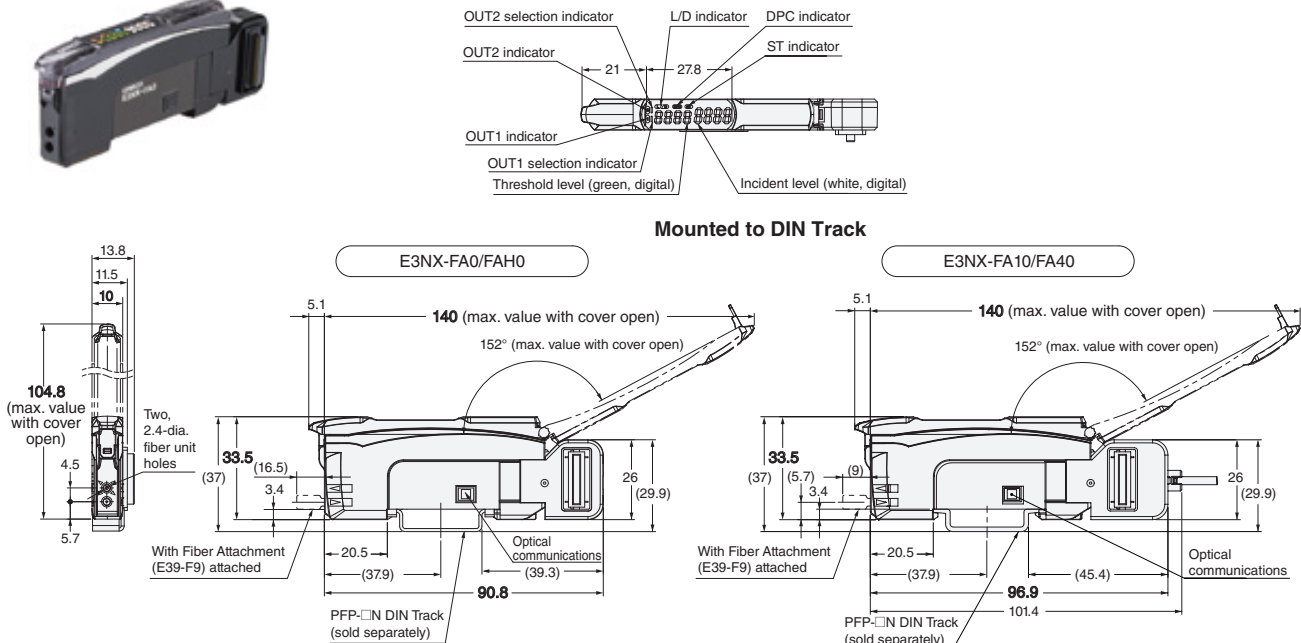

I/O Circuit Diagrams

NPN Output

Models	Operation mode	Timing chart	L/D indicators	Output circuit
E3NX-FA11 E3NX-FA6 E3NX-FA11-5 E3NX-FAH11 E3NX-FAH6	Light-ON		L lit.	
	Dark-ON		D lit.	
E3NX-FA21	Light-ON		L lit.	
	Dark-ON		D lit.	
E3NX-FA7 E3NX-FA24	Light-ON		L lit.	
	Dark-ON		D lit.	
E3NX-FA7TW	Light-ON		L lit.	
	Dark-ON		D lit.	
E3NX-FA11AN	Light-ON		L lit.	
	Dark-ON		D lit.	

• M8 Connector Pin Arrangement

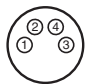

Note. For E3NX-FA6/ FA7/ FA8/ FA9/ FA7TW/ FA9TW/ FAH6/ FAH8, diagram with optional wire-saving connector.

PNP Output

Models	Operation mode	Timing chart	L/D indicators	Output circuit
E3NX-FA41 E3NX-FA8 E3NX-FAH41 E3NX-FAH8	Light-ON		L lit.	
	Dark-ON		D lit.	
E3NX-FA51	Light-ON		L lit.	
	Dark-ON		D lit.	
E3NX-FA9 E3NX-FA54	Light-ON		L lit.	<p>• M8 Connector Pin Arrangement</p>
	Dark-ON		D lit.	
E3NX-FA9TW E3NX-FA54TW	Light-ON		L lit.	<p>• M8 Connector Pin Arrangement</p>
	Dark-ON		D lit.	
E3NX-FA41AN	Light-ON		L lit.	
	Dark-ON		D lit.	

Fiber Sensor Features

Selection Guide

Fiber Units

Threaded
Hex-shaped
Cylindrical

Standard Installation

Flat
Sleeved

Saving Space

Small Spot
High Power

Beam Improvements

Narrow view
BGS

Transparent Objects

Retro-reflective
Limited-reflective

Environmental Immunity

Chemical-resistant, Oil-resistant
Bending

Applications

Heat-resistant
Area Detection

Applications

Liquid-level
Vacuum

Applications

FPD, Semi, Solar

Installation Information

Fiber Amplifiers, Communications Unit, and Accessories

Technical Guide and Precautions

Model Index

Plug (Sensor I/O Connector)

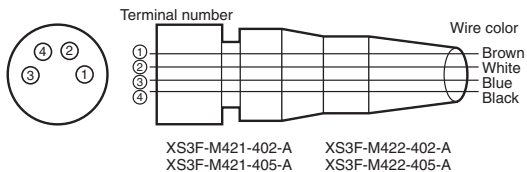

Wire color	Connection pin	Application
Brown	1	Power supply (+V)
White	2	External input / Output
Blue	3	Power supply (0 V)
Black	4	Output

Nomenclature

E3NX-FA11/FA41/FA6/FA8/FA7/FA9/
FA24/FA54/FA11-5/FAH11/FAH41/
FAH6/FAH8/FA11AN/FA41AN

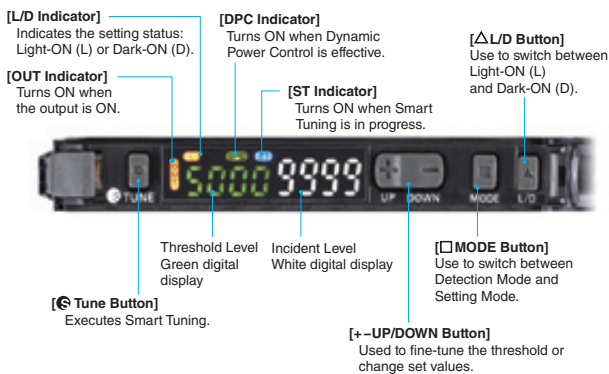

E3NX-FA21/FA51/FA7TW/FA9TW/FA54TW/
FA10/FA40/FA0/FAH0

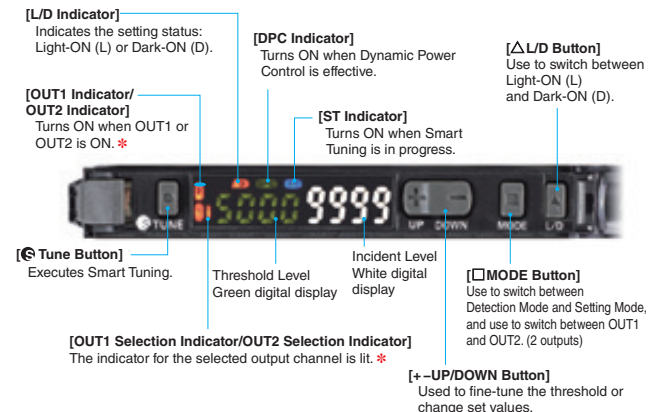

* Only OUT1 turns ON for output.

Operating Procedures

Basic Settings

Output switching

1. Press [L/D] button.

Through-beam:
Set to "Dark ON" to turn the output ON with a workpiece in the detection area. [L/D Indicator] turns **D** ON.

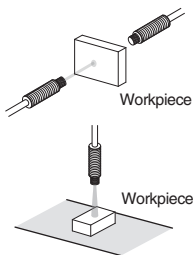

Reflective:
Set to "Light ON" to turn the output ON with a workpiece in the detection area. [L/D Indicator] turns **L** ON.

Smart Tuning [Easy Sensitivity Setting]

(1) Detect for Workpiece Presence/Absence

● 2-point Tuning

1. Press [TUNE] button with a workpiece in the detection area.

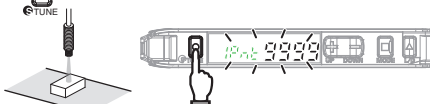

2. Press [TUNE] button again without a workpiece in the detection area. Release the button when [Point] is displayed.

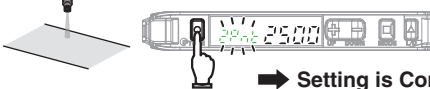

➔ Setting is Completed

Incident light level setting:
The larger incident level of the Step 1 and 2 values is adjusted to the power tuning level.
Threshold setting:
Set to the middle between the Step 1 and 2 incident light levels.



Step 1 and Step 2 can be reversed.

(2) Enhance Durability of the Fiber Head against Dust and Dirt

● Maximum Sensitivity Tuning

1. Hold [TUNE] button for 3 seconds or longer with/without workpiece as shown below. Release the button when [FULL] is displayed.

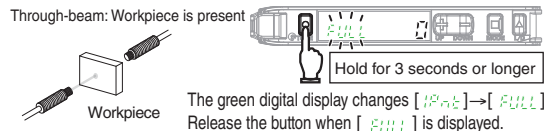

➔ Setting is Completed

Incident light level setting:
The incident level in Step 1 is adjusted to "0".
Threshold setting:
The value is set to approx. 7% of the incident light level of 1.



However, the Sensor becomes more susceptible to the influence of background objects.

(3) Adjust for Moving Workpiece without Stopping Line

● Full Auto Tuning

1. Hold the [TUNE] button without the presence of a workpiece, and pass the workpiece through while [Point] → [FULL] → [Auto] is displayed in green digital.

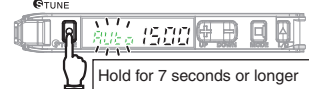
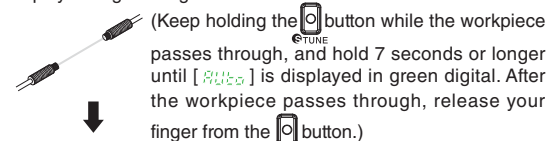

➔ Setting is Completed

Incident light level setting: Adjust the max. incident light level on Step 1 as the power tuning level.
Threshold setting: Set to the middle between max. and min. incident light levels on Step 1.

Basic Settings

(4) Determine Workpiece Position

● Position Tuning

1. Turn ON power tuning in SET mode. Refer to "Detailed Settings"

2. Press button without a workpiece in the area.

3. Place the workpiece at the desired position and hold button.

The green digital display changes [P000] → [P05].

➔ **Setting is Completed**

Incident light level setting: The Step 3 incident level is adjusted to half the power tuning level. Threshold setting: Set to the same value as the Step 3 incident level.

(5) Detect Transparent or Small Workpiece (Set Threshold by incident light level percentage)

● Percentage Tuning

1. Turn ON Percentage Tuning in SET mode. Refer to "Detailed Settings"

2. Press button without a workpiece in the area.

➔ **Setting is Completed**

Incident light level setting: The Step 2 incident light level is adjusted to the power tuning level. Threshold setting: Set to the value obtained by (Incident Level at Step 2 × Percentage Tuning Level).

No Smart Tuning other than Power Tuning can be used if Percentage Tuning is set.

(6) Restore from the Incident Level Changed due to Dust and Dirt

● Power Tuning

1. Hold and buttons for 1 second or longer without a workpiece in the area.

➔ **Setting is Completed**

Incident light level setting: The Step 1 incident level is adjusted to the power tuning level. Threshold setting: Not changed.

Perform the procedure with a workpiece in the area for reflective model setting. If the setting is made after position tuning, set both the through-beam model and reflective model with a workpiece.

Refer to "• Smart Tuning Error" for error displays.

● Smart Tuning Error

Error / Display / Cause	Error Origin Tuning Type	Remedy
Near Error 	2-point Tuning Full Auto Tuning	<ul style="list-style-type: none"> Change the detection function mode to a slower response time mode. Reduce the distance between the emitter and receiver. (Through-beam) Place the Fiber Head closer to the sensing object. (Reflective)
Over Error 	All	<ul style="list-style-type: none"> Use a thin-diameter fiber. Widen the emitter and receiver distance. (Through-beam) Distance the Fiber Head from the sensing object. (Reflective)
Incident light level is too high. Low Error 	Tuning other than Maximum Sensitivity Tuning	<ul style="list-style-type: none"> Reduce the distance between the emitter and receiver. (Through-beam) Place the Fiber Head closer to the sensing object. (Reflective)

Refer to "Detailed Settings" to change the power tuning level.

Channel switching

(Models with 2 Outputs: E3NX-FA21, E3NX-FA51, E3NX-FA7TW, E3NX-FA9TW) and E3NX-FA54TW)

■ The OUT selection indicators and the settings will change.

1. Press button for 1 second.
2. The OUT selection indicators (OUT1/OUT2) switch.

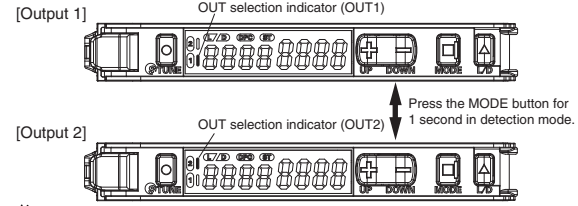

In the detailed settings, the OUT selection indicators will each light whenever the output (OUT1/OUT2) is set.

Minute Adjustment of Threshold Level

1. Press button to adjust the threshold level.

The threshold level becomes higher. The threshold level becomes lower.

Hold the key for high-speed level adjustment.

Convenient Setting Features

(1) Stable Detection Regardless of Incident Level Change due to Dust and Dirt

- DPC Function (Use of the function with Through-beam model or Retro-reflective model is recommended)

1. Perform Smart Tuning.

Refer to "Smart Tuning"
 Refer to "Power Tuning"

2. Set the DPC function ON in SET mode.

Refer to "Detailed Settings"

The DPC indicator turns ON when the DPC function is effective.

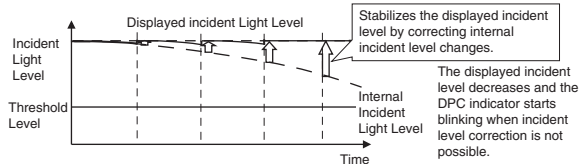

(2) Reset Settings

- Setting Reset

Initializes all the settings by returning them to the factory defaults.

1. Hold button and then hold button for 3 seconds or longer.

2. Select [-SE] in and press button.

3. Select [-SE USE] in and press button.

(3) Save or Read Settings

1. Hold button and then hold button for 3 seconds or longer.

- User Save Function

Saves the current settings.

2. Select [SAVE] in and press button.

3. Select [SAVE USE] in and press button.

- User Reset Function

Reads out the saved settings.

2. Select [-SE] in and press button.

3. Select [-SE USE] in and press button.

(4) Prevent Mistake-operation

- Key Lock Function

Disables all button operations. [LoL ON] is displayed when the button is pressed.

- Enable/Cancel (This procedure)

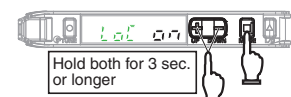

* Press either of UP/DOWN.

Convenient Setting Features

(5) Reset Incident Light Level to "0"

● Zero Reset Function

Changes the incident light level to "0". The threshold level is also shifted accordingly. The lower limit of the threshold is -1,999.

■ Enable

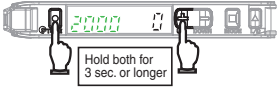

■ Cancel

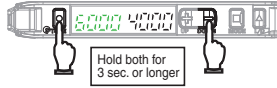

(6) Producing an Output When the Incident Level is within an Area

● Area Detection Mode

1. Select [SET Mode] – [OUT1 Mode] – [Area Detection Mode]. Press MODE button for at least 3 seconds to leave the SET mode.

2. Press MODE button in [Detection Mode] to display OUT1 HIGH and OUT 1 LOW. "HIGH" and "LOW" will appear on the green digital display.

3. Press TUNE button for the high and low thresholds to execute smart tuning.

Percentage Tuning: The thresholds are set as follows:
High: Incident level from step 3 + Incident level from step 3 × Percentage tuning level
Low: Incident level from step 3 – Incident level from step 3 × Percentage tuning level

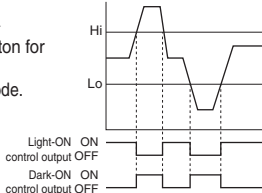

(7) Monitoring the Incident Level for Sensing Objects Passing at High Speed

● Change Finder

1. Select [SET Mode] → [Digital Display] to set [d SP OFF].

2. Press MODE button for 3 seconds or longer to leave the SET mode.

3. Send a workpiece past the Fiber Unit.

4. The maximum and minimum incident levels will be displayed for 0.5 seconds when the workpiece passes.

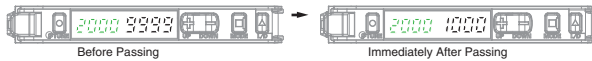

The maximum value and minimum value are displayed with Light-ON and Dark-ON respectively.

(8) Determining If the Workpiece Can Be Detected

● Solution Viewer

1. Press MODE button and LID button together for 3 seconds or longer to set [SolV ON]. To clear the setting, press MODE button and LID button together for 3 seconds or longer to set [SolV OFF].

2. Send a workpiece past the Fiber Unit.

3. Displaying the Passing Time and Difference in Incident Levels.

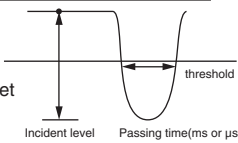
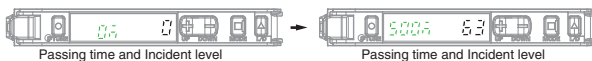

Detailed Settings

Hold MODE button for 3 seconds or longer to enter SET mode. The OUT selection indicators shows items for output 1 or output 2 individually for each output. SET mode provides the function settings described hereafter. The initial display shown after transition from one function to another represents the factory default.

Function Setting	Description																		
<p>1. Function Selection</p> <p>Function Selection: [FUNC OFF]</p> <p>Function Selection: [FUNC OFF]</p>	<p>Changing Functions to Set in SET mode</p> <p>[FUNC]: Functions 1. to 5. can be set [SET]: Functions 1. to 16. can be set.</p>																		
<p>2. Detection Function</p> <p>(Incident Light Level Example)</p> <p>(a) HS 500</p> <p>(b) STND 500</p> <p>(c) GIGA 4000</p> <p>(d) SHS 125</p> <p>(e) SHS2 50</p> <p>SHS2 Super High-speed Mode</p>	<p>Changing Light Level and Response Time</p> <table border="1"> <thead> <tr> <th>Detection Function</th> <th>Response Time</th> <th>Light Level</th> </tr> </thead> <tbody> <tr> <td>(a) HS High-speed mode</td> <td>250 μs</td> <td>1 (Standard)</td> </tr> <tr> <td>(b) STND Standard mode</td> <td>1ms</td> <td>1 time</td> </tr> <tr> <td>(c) GIGA Giga mode</td> <td>16ms</td> <td>8 times</td> </tr> <tr> <td>(d) SHS Super High-speed mode*2</td> <td>30μs</td> <td>0.1 times</td> </tr> <tr> <td>(e) SHS2 Super High-speed Mode</td> <td>60μs</td> <td>0.1 times</td> </tr> </tbody> </table> <p>Smart Tuning is canceled if the detection mode is changed.</p> <p>*2 The communication and mutual interference prevention functions are disabled when the detection mode is set to super-high-speed mode. The response time for models with 2 outputs is 32 μs</p>	Detection Function	Response Time	Light Level	(a) HS High-speed mode	250 μs	1 (Standard)	(b) STND Standard mode	1ms	1 time	(c) GIGA Giga mode	16ms	8 times	(d) SHS Super High-speed mode*2	30μs	0.1 times	(e) SHS2 Super High-speed Mode	60μs	0.1 times
Detection Function	Response Time	Light Level																	
(a) HS High-speed mode	250 μs	1 (Standard)																	
(b) STND Standard mode	1ms	1 time																	
(c) GIGA Giga mode	16ms	8 times																	
(d) SHS Super High-speed mode*2	30μs	0.1 times																	
(e) SHS2 Super High-speed Mode	60μs	0.1 times																	
<p>3. DPC Function</p> <p>DPC OFF</p> <p>DPC ON</p>	<p>Stable Detection Regardless of Incident Light Level Change</p> <p>Refer to "Convenient Setting Features"</p>																		
<p>4. Timer Function</p> <p>toff</p> <p>(a) toff 10</p> <p>(b) on-d 10</p> <p>(c) shot 10</p> <p>(d) on-df</p>	<p>Setting Output Timer</p> <p>(Settings are displayed for both outputs for models with 2 outputs.)</p> <table border="1"> <thead> <tr> <th>Off-delay Timer</th> <th>On-delay Timer</th> <th>One-shot Timer</th> <th>ON/OFF-delay Timer</th> </tr> </thead> <tbody> <tr> <td>Holds the output ON for detection by PLC when the detection time is too short.</td> <td>Delays the output ON after detection.</td> <td>Keeps the output ON for a specified time regardless of the workpiece size variations.</td> <td>Sets both ON-delay and OFF-delay timers.</td> </tr> </tbody> </table> <p>A timer value can be set after pressing MODE button when a timer menu (other display than "----") is displayed. Use UP/DOWN button to set the time. (1 to 9999 ms in 1 ms steps; the initial value: 10 ms)</p>	Off-delay Timer	On-delay Timer	One-shot Timer	ON/OFF-delay Timer	Holds the output ON for detection by PLC when the detection time is too short.	Delays the output ON after detection.	Keeps the output ON for a specified time regardless of the workpiece size variations.	Sets both ON-delay and OFF-delay timers.										
Off-delay Timer	On-delay Timer	One-shot Timer	ON/OFF-delay Timer																
Holds the output ON for detection by PLC when the detection time is too short.	Delays the output ON after detection.	Keeps the output ON for a specified time regardless of the workpiece size variations.	Sets both ON-delay and OFF-delay timers.																
<p>5. Power Tuning Level</p> <p>P-Lw 9999</p> <p>Function Selection: [SPLE]</p> <p>Function Selection: [SPLE]</p>	<p>Changing the Target Incident Light Level (Power Tuning Level)</p> <p>Use UP/DOWN button to set the power tuning level.</p> <p>[100 to 9999 in 1 steps; the initial value: 9999]</p> <p>Refer to "Convenient Setting Features"</p>																		
<p>6. BANK Switching</p> <p>BANK 1</p> <p>BANK 1</p> <p>BANK 2</p> <p>BANK 3</p> <p>BANK 4</p>	<p>Saving Settings in Each Bank</p>																		

Threaded	Standard Installation
Hex-shaped	
Cylindrical	

Flat	Saving Space
Sleeved	

Small Spot	Beam Improvements
High Power	

Narrow view	Transparent Objects
BGS	

Retro-reflective	Environmental Immunity
Limited-reflective	

Chemical-resistant, Oil-resistant	Applications
Bending	

Heat-resistant	Area Detection
Liquid-level	

Vacuum	FPD, Semi, Solar
Installation Information	

Fiber Amplifiers, Communications Unit, and Accessories
--

Technical Guide and Precautions

Model Index

Function Setting	Description																								
7. Power Tuning ON/OFF Setting 	Setting ON or OFF Incident Level Adjustment when Tuning																								
8. Percentage Tuning 	Detecting Transparent or Small Workpiece Press button in [PEr ON] menu, then use button to set the percentage tuning level. (~99% to 99% in 1% steps; the initial value: -10%) Refer to "Smart Tuning"																								
9. Output 1 Mode 	Changing the Output Mode for Output 1 Normal Detection Mode Area Detection Mode																								
10. Output 2 Mode 	Changing the Output Mode for Output 2 Alarm Output Mode: Press button and then set the alarm output level with button. (0 to 100 P in 1-P increments, default: 50 P) ON-delay of 300 ms is applied. Error Output Mode: An output is made when a DPC error, EEPROM error, or Load short circuit detection error occurs.																								
11. External Input 	Changing the Type of External Input The closed-circuit input time for tuning is the same as the key input time.																								
	<table border="1"> <thead> <tr> <th></th> <th>First point</th> <th>Second point</th> </tr> </thead> <tbody> <tr> <td>2-point Tuning</td> <td>Less than 3 seconds</td> <td>Less than 3 seconds</td> </tr> <tr> <td>Maximum Sensitivity Tuning</td> <td>3 seconds min. Less than 7 seconds</td> <td>—</td> </tr> <tr> <td>Full Auto Tuning</td> <td>7.0 s or longer</td> <td>—</td> </tr> <tr> <td>Position Tuning</td> <td>Less than 3 seconds</td> <td>3 seconds or longer</td> </tr> <tr> <td>Power/percentage tuning</td> <td>25 ms min.</td> <td>—</td> </tr> <tr> <td></td> <td>Enable</td> <td>Cancel</td> </tr> <tr> <td>Zero reset</td> <td>Less than 3 seconds</td> <td>3 seconds min.</td> </tr> </tbody> </table>		First point	Second point	2-point Tuning	Less than 3 seconds	Less than 3 seconds	Maximum Sensitivity Tuning	3 seconds min. Less than 7 seconds	—	Full Auto Tuning	7.0 s or longer	—	Position Tuning	Less than 3 seconds	3 seconds or longer	Power/percentage tuning	25 ms min.	—		Enable	Cancel	Zero reset	Less than 3 seconds	3 seconds min.
	First point	Second point																							
2-point Tuning	Less than 3 seconds	Less than 3 seconds																							
Maximum Sensitivity Tuning	3 seconds min. Less than 7 seconds	—																							
Full Auto Tuning	7.0 s or longer	—																							
Position Tuning	Less than 3 seconds	3 seconds or longer																							
Power/percentage tuning	25 ms min.	—																							
	Enable	Cancel																							
Zero reset	Less than 3 seconds	3 seconds min.																							
12. Batch Tuning Settings 	Tuning Multiple Amplifiers at Once When a setting other than OFF is selected, the percentage tuning setting is displayed continuously. When using the batch tuning function, set tuning for the external input (11).																								

Function Setting	Description																																								
13. Digital Display 	Changing Digital Display in RUN Mode for Specific Purpose Checking a Margin Against Threshold <table border="1"> <tr> <td>Threshold</td> <td>Light Level Ratio</td> <td>The ratio of the incident light level to the threshold is displayed in white digital figures.</td> </tr> <tr> <td>20000</td> <td>10000</td> <td></td> </tr> </table> Setting Threshold using a Small or Fast Moving Workpiece <table border="1"> <tr> <td>Peak Light Level</td> <td>Bottom Light Level</td> <td>Holds and displays the minimum value of the peak of the light incident and the maximum value of the bottom of the light interruption.</td> </tr> <tr> <td>50000</td> <td>20000</td> <td></td> </tr> </table> Setting for Intuitive Analog Display <table border="1"> <tr> <td>Threshold</td> <td>120%</td> <td>100%</td> <td>80%</td> <td>Displays the current level in the 80 to 120% range against the threshold value (100%).</td> </tr> <tr> <td></td> <td colspan="3"></td> <td></td> </tr> </table> Adjusting Optical Axis <table border="1"> <tr> <td>Peak Light Level</td> <td>Light Level</td> <td>Holds the peak incident light level and displays it in green digital figures.</td> </tr> <tr> <td>30000</td> <td>20000</td> <td></td> </tr> </table> Checking the Channel No. in Group Mounting <table border="1"> <tr> <td>Ch. No.</td> <td>Light Level</td> <td>Checking the Channel No. in Group Mounting.</td> </tr> <tr> <td>1ch</td> <td>20000</td> <td></td> </tr> </table> Checking the Light Level of Fast Moving Workpiece <table border="1"> <tr> <td>Threshold</td> <td>Light level when the workpiece passes</td> <td>Light level when the workpiece passes is displayed in white digital figures for 0.5 seconds.</td> </tr> <tr> <td>20000</td> <td>20000</td> <td></td> </tr> </table>	Threshold	Light Level Ratio	The ratio of the incident light level to the threshold is displayed in white digital figures.	20000	10000		Peak Light Level	Bottom Light Level	Holds and displays the minimum value of the peak of the light incident and the maximum value of the bottom of the light interruption.	50000	20000		Threshold	120%	100%	80%	Displays the current level in the 80 to 120% range against the threshold value (100%).						Peak Light Level	Light Level	Holds the peak incident light level and displays it in green digital figures.	30000	20000		Ch. No.	Light Level	Checking the Channel No. in Group Mounting.	1ch	20000		Threshold	Light level when the workpiece passes	Light level when the workpiece passes is displayed in white digital figures for 0.5 seconds.	20000	20000	
Threshold	Light Level Ratio	The ratio of the incident light level to the threshold is displayed in white digital figures.																																							
20000	10000																																								
Peak Light Level	Bottom Light Level	Holds and displays the minimum value of the peak of the light incident and the maximum value of the bottom of the light interruption.																																							
50000	20000																																								
Threshold	120%	100%	80%	Displays the current level in the 80 to 120% range against the threshold value (100%).																																					
Peak Light Level	Light Level	Holds the peak incident light level and displays it in green digital figures.																																							
30000	20000																																								
Ch. No.	Light Level	Checking the Channel No. in Group Mounting.																																							
1ch	20000																																								
Threshold	Light level when the workpiece passes	Light level when the workpiece passes is displayed in white digital figures for 0.5 seconds.																																							
20000	20000																																								
14. Inverted Display 	Mounting Amplifier in Inverted Direction Inverts the display upside down. The digital display shows the threshold value in green, and light incident level in white.																																								
15. Eco Function 	Saving Power Consumption ECO on Indicators (Green and White digital displays) turn OFF in approx. 10 seconds after a key operation. ECO Lo Indicators (Green and White digital displays) turn ON with low brightness in approx. 10 seconds after a key operation.																																								
16. Hysteresis width 	Changing the Hysteresis Width The hysteresis width is set to a default value. The hysteresis width is set so that the judgement output is stable near the threshold value. Be sure to check the stability of outputs as there is a possibility of chattering. Press button with [HUSr] displayed and then set the hysteresis width with button. (0 to 9999)																																								
17. Using the External Input to Write to EEPROM 	Turning ON and OFF Writing to EEPROM The settings that have been changed by an external input with [OFF] will not be overwritten to prevent EEPROM from reaching its lifespan (1,000,000 writings).																																								

Ratings and Specifications

Item	Models	E3NW-ECT	E3NW-DS
Connectable Sensor Amplifier Units	N-Smart		
	Smart Fiber Amplifier Unit:	E3NX-FA0/FA10/FA40	
	Smart Fiber Amplifier Unit (Infrared models):	E3NX-FAH0	
	Color Fiber Amplifier Unit:	E3NX-CA0 *1	
	Smart Laser Amplifier Unit:	E3NC-LA0	
	Smart Laser Amplifier Unit (CMOS type):	E3NC-SA0	
Contact-Type Smart Amplifier Unit:	E9NC-TA0 *2		
Power supply voltage	24VDC (20.4 to 26.4 VDC)		
Power and current consumption	2.4 W max. (Not including the power supplied to Sensor.) 100 mA max. (Not including the current supplied to Sensor.)		2 W max. (Not including the power supplied to Sensor.) 80 mA max. (Not including the current supplied to Sensor.)
Indicators	L/A IN Indicator (Green), L/A OUT Indicator (Green), PWR Indicator (Green), RUN Indicator (Green), ERROR Indicator (Red), and SS (Sensor Status) indicator (Green/Red)		RUN Indicator (Green), and SS (Sensor Status) indicator (Green/Red)
Vibration resistance (destruction)	10 to 60 Hz with a 0.7-mm double amplitude, 60 to 150 Hz 50 m/s ² for 1.5 hours each in X, Y, and Z directions		
Shock resistance (destruction)	Destruction: 150 m/s ² for 3 times each in X, Y, and Z directions		
Ambient temperature range	Operating: 0 to 55°C, *3 Storage: -30 to 70°C (with no icing or condensation)		
Ambient humidity range	Operating and storage: 25% to 85% (with no condensation)		
Maximum connectable Sensors	30 *4		10
Maximum connectable Distributed Sensor units	8		—
Insulation resistance	20 MΩ min. (at 500 VDC)		
Dielectric strength	500 VAC 50/60Hz 1 min		
Mounting method	35-mm DIN track-mounting		
Weight (packed state/unit only)	Approx. 185 g/Approx. 95 g		Approx. 160 g/Approx. 40 g
Materials	Polycarbonate		
Accessories	Power supply connector, Communications connector for E3NW-DS, DIN Track End Plates (2) and Instruction manual		Power supply/communications connector, DIN Track End Plates (2), Ferrite cores (2) and Instruction manual

*1. The E3NX-CA0 is supported for firmware version 1.06 or higher (Sensor Communications Units manufactured in June 2016 or later).

*2. The E9NC-TA0 is supported for firmware version 1.03 or higher (Sensor Communications Units manufactured in July 2014 or later).

*3. Temperature Limitations Based on Number of Connected Amplifier Units:

Groups of 1 or 2 Amplifiers: 0 to 55°C, Groups of 3 to 10 Amplifiers: 0 to 50°C, Groups of 11 to 16 Amplifiers: 0 to 45°C, Groups of 17 to 30 Amplifiers: 0 to 40°C

*4. A maximum total of 30 Sensors can be connected to a Sensor Communications Unit and Distributed Sensor Units.

Communications Specifications

Item	Specifications
Protocol	EtherCAT
Modulation	Baseband
Baud rate	100 Mbps
Physical layer	100Base-TX (IEEE802.3u)
Topology	Daisy chain
Communications media	STP category 5 or higher
Communications distance	100 m max. between nodes
Noise immunity	Compliant with IEC 61000-4-4, 1 kV min.
Node address setting method	Set the decimal rotary switches or software *1
Node address range	000 to 192 *2

*1. The software setting is used when the node address setting switches are set to 0.

*2. The range depend on the EtherCAT master that is used. Refer to the E3NW-ECT EtherCAT Sensor Communications Unit Operation Manual for details.

CC-Link-compatible products are also available. Refer to your OMRON website for details.

Threaded
Hex-shaped
Cylindrical

Flat
Sleeved

Small Spot
High Power
Narrow
view
BGS

Retro-
reflective
Limited-
reflective

Chemical-
resistant,
Oil-resistant
Bending
Heat-
resistant

Area
Detection
Liquid-level
Vacuum
FPD,
Semi,
Solar

Dimensions

(Unit: mm)
Tolerance class IT16 applies to demmensions in this date sheet unless otherwise specified.

Sensor Communications Unit

85-A E3NW-ECT

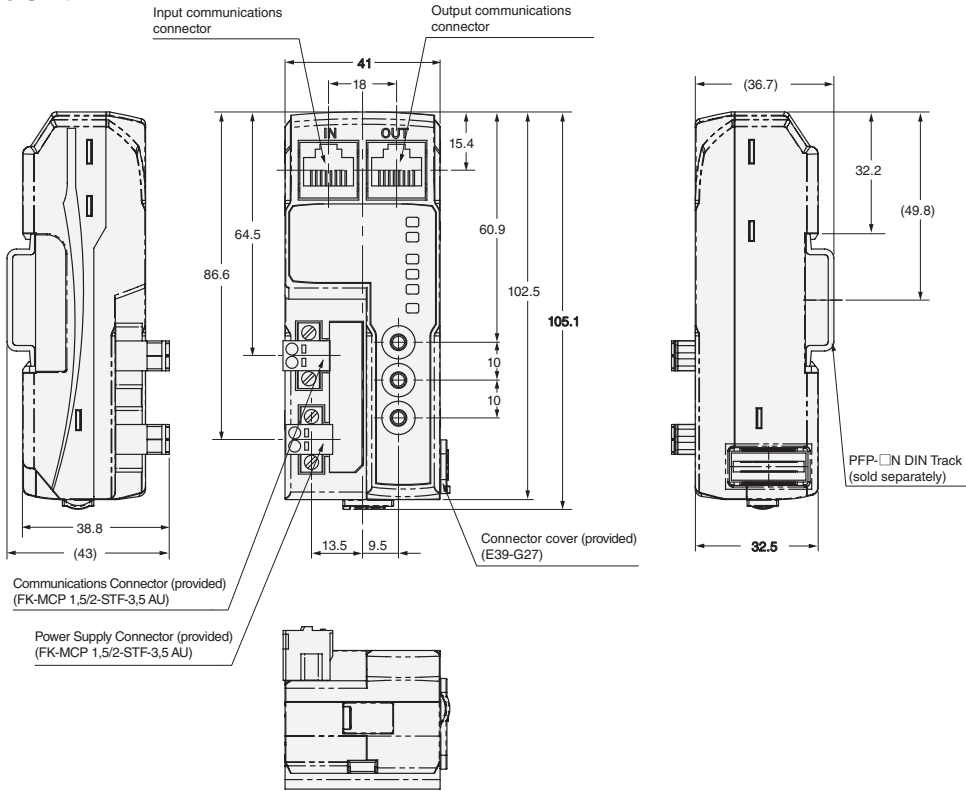

Distributed Sensor Unit

85-B E3NW-DS

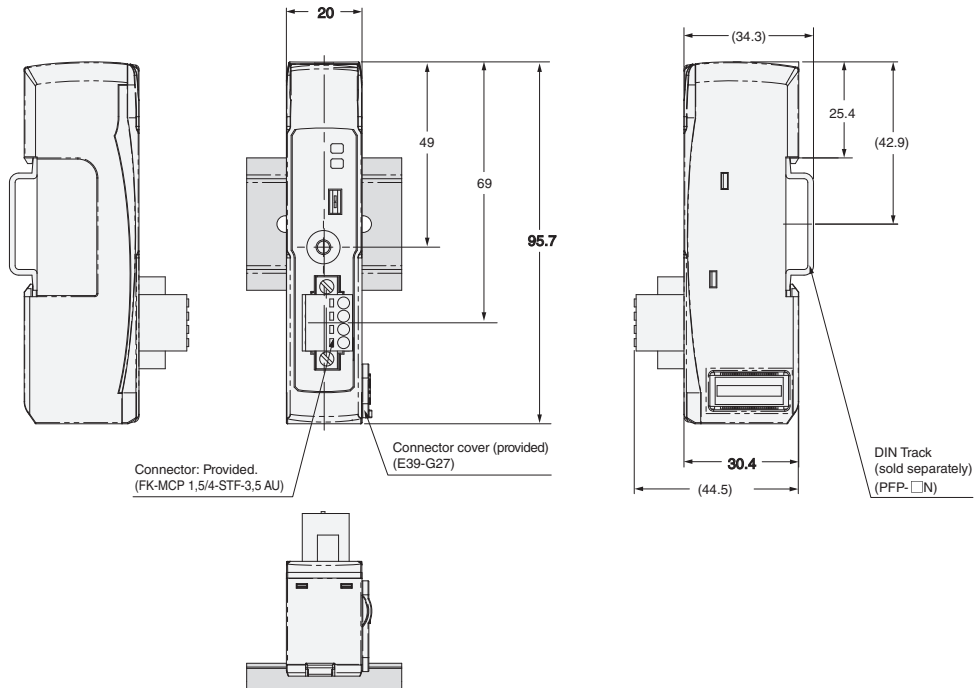

Fiber Sensor Features

Selection Guide

Fiber Units

Threaded
Hex-shaped
Cylindrical

Standard Installation

Flat
Sleeved

Saving Space

Small Spot
High Power
Narrow view
BGS

Beam Improvements

Retro-reflective
Limited-reflective

Transparent Objects

Chemical-resistant, Oil-resistant
Bending
Heat-resistant

Environmental Immunity

Area Detection
Liquid-level
Vacuum
FPD, Semi, Solar

Applications

Installation Information



Fiber Amplifiers, Communications Unit, and Accessories

Technical Guide and Precautions

Model Index

E3X-ZV Fiber Amplifier Units and Related Products



Fiber Amplifier Units E3X-ZV Series

Type	Appearance	Connecting method	Models		Ratings and Specifications	Dimensions
			NPN output	PNP output		
Standard models		Pre-wired (2 m)	E3X-ZV11 2M	E3X-ZV41 2M	Page 88	Page 89 89-A
		Wire-saving Connector	E3X-ZV6	E3X-ZV8		Page 89 89-B

Accessories (sold separately)

Wire-saving connectors (Required for models for Wire-saving Connectors.)

Connectors are not provided with the Fiber Amplifier Unit and must be ordered separately. * Protective stickers: provided.

Type	Appearance	Cable length	Number of conductors	Models	Ratings and Specifications	Dimensions
Master Connector		2m	3	E3X-CN11	Page 94	Page 94 94-A
Slave Connector			1	E3X-CN12		Page 94 94-B

Mounting Bracket

A Mounting Bracket is not provided with the Fiber Amplifier Unit and must be ordered separately as required.

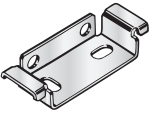
Appearance	Model	Quantity	Dimensions
	E39-L143	1	Page 95 95-A

DIN Track

A Din Track is not provided with the Fiber Amplifier Unit and must be ordered separately as required.

Appearance	Type	Models	Quantity	Dimensions
	Shallow type, total length: 1 m	PFP-100N	1	Page 95 95-B
	Shallow type, total length: 0.5 m	PFP-50N		Page 86 95-C
	Deep type, total length: 1 m	PFP-100N2		

End Plate

Two End Plates are provided with the Sensor Communications Unit.

End Plates are not provided with the Fiber Amplifier Unit and must be ordered separately as required.

Appearance	Model	Quantity	Dimensions
	PFP-M	1	Page 95 95-D

Threaded
Hex-shaped
Cylindrical

Flat
Sleeved

Small Spot
High Power
Narrow view

Retro-reflective
Limited-reflective

Chemical-resistant,
Oil-resistant
Bending
Heat-resistant

Area Detection
Liquid-level
Vacuum
FPD,
Semi,
Solar

Ratings and Specifications

Item	Type	Standard models	
	NPN output	E3X-ZV11	E3X-ZV6
	PNP output	E3X-ZV41	E3X-ZV8
	Connecting method	Pre-wired	Wire-saving Connector
Outputs	1 output		
Light source (wavelength)	Red, 4-element LED (625 nm)		
Power supply voltage	12 to 24 VDC \pm 10%, ripple (p-p) 10% max.		
Power consumption	Normal mode: 720 mW max. (Power supply voltage 24 V: Current consumption 30 mA max. / Power supply voltage 12 V: Current consumption 60 mA max.) Eco function ON: 530 mW max. (Power supply voltage 24 V: Current consumption 22 mA max. / Power supply voltage 12 V: Current consumption 44 mA max.)		
Control output	Load power supply voltage: 26.4 VDC, open collector output type (NPN or PNP output differs depending on the type.) Load current: 100 mA max. (Residual voltage: Load current less than 10 mA: 1 V max., load current 10 to 100 mA: 2 V max.) OFF current: 0.1 mA max.		
Indicators	7-segment displays (Threshold Level display: green, Incident Light Level display: red) Display direction: Switchable between normal and reversed. Smart Tuning Indicator (green) Standard models only: OUT indicator (orange) 2-channel models only: OUT1/2 indicator (orange), CH Indicator (green)		
Protection circuits	Power supply reverse polarity protection, output short-circuit protection and output reverse polarity protection		
Response time	Super-highspeed mode (SHS)	Operate or reset: 50 μ s	
	High-speed mode (HS)	Operate or reset: 250 μ s *1	
	Standard mode (Std)	Operate or reset: 1 ms *3	
	Giga-power mode (GIGA)	Operate or reset: 16 ms	
Sensitivity adjustment	Smart Tuning (2-point tuning, power tuning, percentage tuning (-99% to 99%), maximum sensitivity tuning, full auto tuning, position tuning) or manual adjustment		
Maximum connectable Units	16		
Mutual interference prevention function	Emission cycle setting switching type (up to 4 units)		
Functions	DPC (Dynamic Power Control)	Yes	
	ATC (Active Threshold Control)	Yes	
	Timer	Select from timer disabled, OFF-delay, ON-delay or one-shot timer: 1 to 9,999 ms	
	Zero reset	Negative values can be displayed. (Threshold value is shifted.)	
	Resetting settings	Select from initial reset (factory defaults) or user reset (saved settings).	
	Eco mode	Select from OFF (digital display lit) and Eco ON (digital display not lit).	
Power tuning	Select from ON or OFF.		
Ambient illumination (Receiver side)	Incandescent lamp: 20,000 lx max., Sunlight: 30,000 lx max.		
Ambient temperature range	Operating: -25°C to 55°C Storage: -30°C to 70°C (with no icing or condensation)		
Ambient humidity range	Operating and storage: 35 to 85% (with no condensation) within the surrounding air temperature range shown above		
Insulation resistance	20 M Ω min. (at 500 VDC)		
Dielectric strength	1,000 VAC at 50/60 Hz for 1 min		
Vibration resistance (destruction)	10 to 55 Hz with a 1.5-mm double amplitude for 2 hours each in X, Y, and Z directions		
Shock resistance (destruction)	500 m/s ² for 3 times each in X, Y, and Z directions		
Weight (packed state/Sensor only)	Approx. 95 g/ approx. 65 g	Approx. 45 g/ approx. 20 g	
Materials	Case	Polycarbonate (PC).	
	Cover	Polycarbonate (PC)	
	Cable	PVC	
Accessories	Instruction manual, Compliance sheet		

*1.Mutual interference prevention function in the Response Time Priority Mode: 2 units: 350 μ s; 3 units: 400 μ s / In the Unit Number Priority Mode: 4 units: 700 μ s

*2.Mutual interference prevention function in the Unit Number Priority Mode: 4 units: 1.6 ms

(Unit: mm)

Tolerance class IT16 applies to demmensions in this date sheet unless otherwise specified.

Dimensions

Pre-wired Amplifier Units

89-A E3X-ZV11
E3X-ZV41

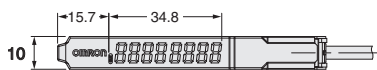

*1. The Mounting Bracket can also be used on side B.
*2. Cable Specifications

Outer diameter	No. of conductors	Others
4.0 dia.	3	Conductor cross-section: 0.12 mm ²
		Insulator dia.: 0.9 mm
		Standard cable length: 2 m
		Minimum bending radius: 12 mm (Reference value)

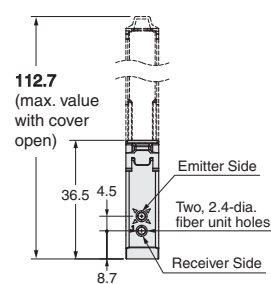

Mounted to DIN Track

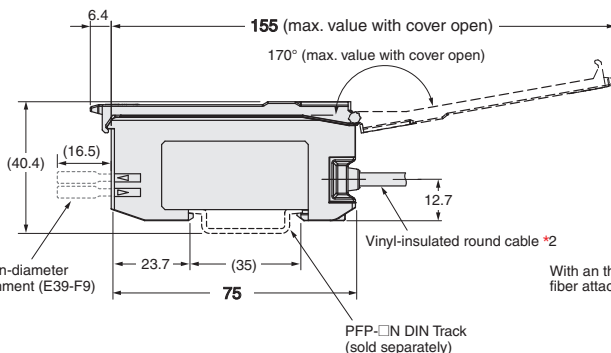

With Mounting Bracket Attached

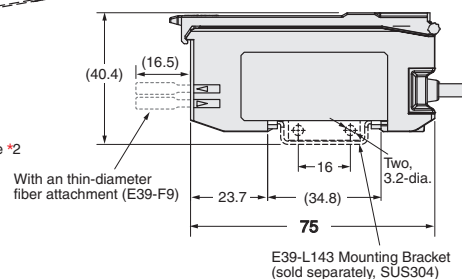

Mounting Holes

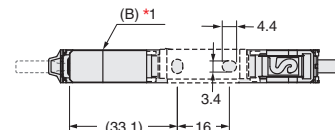
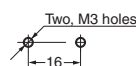

Wire-saving Connectors Units

89-B E3X-ZV6
E3X-ZV8

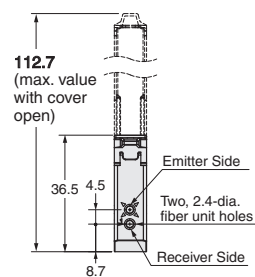
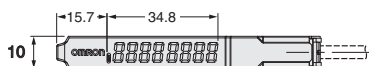

Mounted to DIN Track

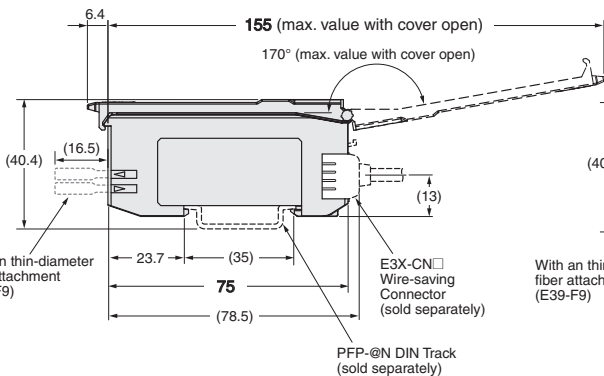

With Mounting Bracket Attached

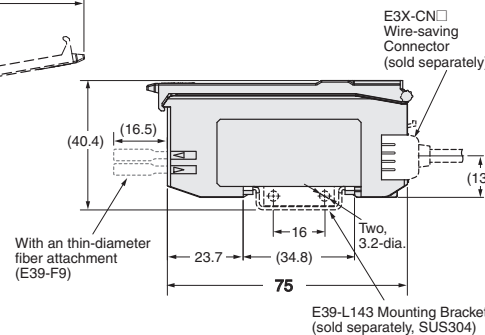

Mounting Holes

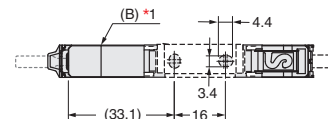
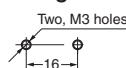

*1. The Mounting Bracket can also be used on side B.

Fiber Sensor Features

Selection Guide

Fiber Units

Threaded
Hex-shaped
Cylindrical

Standard Installation

Flat
Sleeved

Saving Space

Small Spot
High Power

Beam Improvements

Narrow view
BGS

Transparent Objects

Retro-reflective
Limited-reflective

Chemical-resistant, Oil-resistant

Bending

Environmental Immunity

Heat-resistant

Area Detection

Liquid-level

Vacuum

FPD, Semi, Solar

Applications

Installation Information

Fiber Amplifiers, Communications Unit, and Accessories

Technical Guide and Precautions

Model Index

I/O Circuit Diagrams

NPN Output

Model	Operation mode	Timing chart	Output circuit
E3X-ZV11 E3X-ZV6	Light-ON	Incident light: [Bar chart showing pulse] No incident light: [Bar chart showing low level] OUT indicator (orange): Lit [Bar chart showing pulse] Not lit [Bar chart showing low level] Output transistor: ON [Bar chart showing pulse] OFF [Bar chart showing low level] Load (e.g., relay): Operate [Bar chart showing pulse] Reset [Bar chart showing low level] (Between brown and black leads)	
	Dark-ON	Incident light: [Bar chart showing pulse] No incident light: [Bar chart showing low level] OUT indicator (orange): Lit [Bar chart showing pulse] Not lit [Bar chart showing low level] Output transistor: OFF [Bar chart showing low level] ON [Bar chart showing pulse] Load (e.g., relay): Operate [Bar chart showing pulse] Reset [Bar chart showing low level] (Between brown and black leads)	

PNP Output

Model	Operation mode	Timing chart	Output circuit
E3X-ZV41 E3X-ZV8	Light-ON	Incident light: [Bar chart showing pulse] No incident light: [Bar chart showing low level] OUT indicator (orange): Lit [Bar chart showing pulse] Not lit [Bar chart showing low level] Output transistor: OFF [Bar chart showing low level] ON [Bar chart showing pulse] Load (e.g., relay): Operate [Bar chart showing pulse] Reset [Bar chart showing low level] (Between blue and black leads)	
	Dark-ON	Incident light: [Bar chart showing pulse] No incident light: [Bar chart showing low level] OUT indicator (orange): Lit [Bar chart showing pulse] Not lit [Bar chart showing low level] Output transistor: OFF [Bar chart showing low level] ON [Bar chart showing pulse] Load (e.g., relay): Operate [Bar chart showing pulse] Reset [Bar chart showing low level] (Between blue and black leads)	

Nomenclature

E3X-ZV11
E3X-ZV41
E3X-ZV6
E3X-ZV8

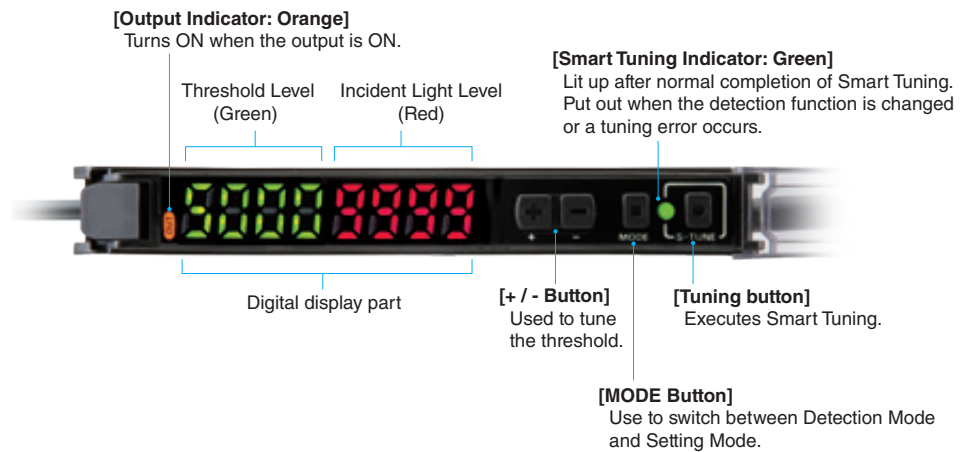



Operating Procedures

Basic Settings

Output switching

Selection of Light ON (L-ON) or Dark ON (D-ON)

• Output switching

1. Hold the  button for 3 seconds or longer to enter the SET Mode.
2. Press the  button to select the following item.

In the case of diffuse reflection type or limited reflection type

In the case of through-beam type or regressive reflection type

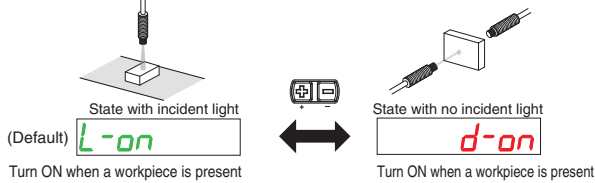

3. Press the  button for 3 seconds or longer to return to the Detection Mode.

Adjustment of Threshold Level

• Minute Adjustment of Threshold Level

Set the threshold level in the Detection Mode.

Press the  button to adjust the threshold level.



Hold the key for high-speed level adjustment.







Initialization

Initializing Settings

• Setting Reset

Initialize all settings to the factory-set defaults.

1. Hold the  button for 3 seconds or longer to enter the SET Mode.
2. Press the  button twice. **rSt no**
3. Press the  button once. **rSt YES** Initialization selected
4. Press the  button once. **int ok** Initialization completed



Settings can also be initialized by pressing the MODE button for 7 seconds or longer in the Detection Mode. Contents saved by User Save Function are not cleared by the setting initialization.

Basic Smart Tuning Method

Adjust the received light intensity and the threshold to appropriate values through Smart Tuning.

Most Basic Setting Method

• 2-point Tuning

1. Press the  button with a workpiece in the detection area.

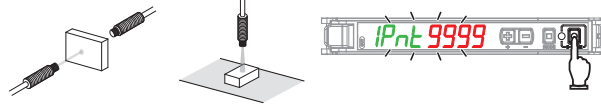

2. Press the  button again without a workpiece in the detection area.

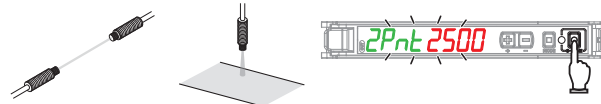

Incident light level setting: The larger incident level of the Step 1 and 2 values is adjusted to the power tuning level.



Threshold setting: Set to the middle between the Step 1 and 2 incident light levels.



Step 1 and Step 2 can be reversed.

Making Received Light Intensity Uniform

• Power Tuning

1. Hold the  and  buttons for 1 second or longer and release the button when [PTLn] appears.



Incident light level setting: The Step 1 incident level is adjusted to the power tuning level.

Threshold setting: Not changed. If the value is low, it will be set to the minimum value in which an output is turned ON / OFF correctly.





Perform the procedure with a workpiece in the area for reflective model setting. If the setting is made after position tuning, set both the through-beam model and reflective model with a workpiece.

When power tuning ON / OFF setting is OFF, power tuning cannot be performed.

Setting a Threshold with Received Light Intensity Ratio

• Percentage Tuning

1. Turn ON Percentage Tuning in SET mode.  Refer to "Detailed Settings".
2. Hold the  button for 1 second or longer without a workpiece in the area.

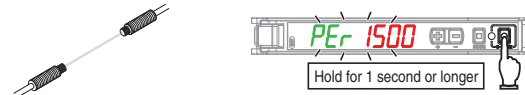

Incident light level setting: The Step 2 incident light level is adjusted to the power tuning level.

Threshold setting: Set to [Set received light intensity x Percentage tuning level].



No Smart Tuning other than Power Tuning can be used if Percentage Tuning is set. Set the Percentage tuning level to be below 0 in the case of a through-beam type (Dark ON: D-ON), or to be above 0 in the case of a reflective type (Light ON: L-ON).

Threaded	Standard Installation
Hex-shaped	
Cylindrical	
Flat	Saving Space
Sleeved	
Small Spot	Beam Improvements
High Power	
Narrow view	Transparent Objects
BGS	
Retro-reflective	Environmental Immunity
Limited-reflective	
Chemical-resistant, Oil-resistant	Applications
Bending	
Heat-resistant	Applications
Area Detection	
Liquid-level	Applications
Vacuum	
FPD, Semi, Solar	Installation Information

Operating Procedures

Convenient Setting Features

Various Smart Tuning Methods



When Received Light Intensity Decreases due to Dust or Dirt

• Maximum Sensitivity Tuning

Long-press the  button for 3 seconds or longer in the presence of a workpiece in the case of through-beam type or without the presence of a workpiece in the case of reflective type, and then take your finger off the button when [FULL] is displayed on the green digital display part.



The green digital display changes [IPnL] → [FULL].

Incident light level setting: The incident level when the  button pressed is adjusted to "0".
Threshold setting: The value is set to approx.

7% of the incident light level when the  button pressed.
If the incident light level when the  button pressed is smaller during long distance detection, the minimum value by which an output is correctly turned ON will be set.

Making Adjustment with Passing Workpiece

• Full Auto Tuning



Hold the  button without the presence of a workpiece, and pass the workpiece through while [IPnL] → [FULL] → [AUTO] is displayed in green digital. (Keep holding the  button while the workpiece passes through, and hold 7 seconds or longer until [AUTO] is displayed in green digital. After the workpiece passes through, release your finger from the  button.)

Incident light level setting: Adjust the max. incident light level while pressing the  button as the power tuning level.

Threshold setting: Set to the middle between max. and min. incident light levels while pressing the  button.

Determine Workpiece Position

• Position Tuning

1. Press the  button without a workpiece in the area.
The green digital display changes [IPnL].
2. Place the workpiece at the desired position and hold the  button for 3 seconds or longer.
The green digital display changes [2PnL] → [P05].

Incident light level setting: The Step 2 incident level is adjusted to half the power tuning level.
Threshold setting: Set to the same value as the Step 2 incident level.

Convenient Settings

Preventing Malfunction

• Key Lock Function

Enable / Cancel (Same procedure)

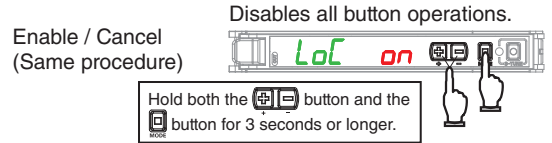

Disables all button operations.

* Press either of the + or - button.

Returning Received Light Intensity Display to "0"

• Zero Reset Function

Enable

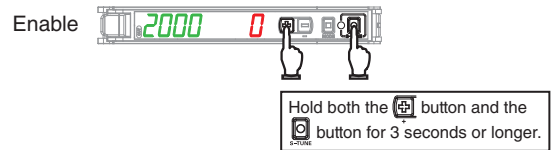

 The zero reset function is canceled when either of the DPC function / differential function / Smart Tuning is performed.
When DPC (ATC) function or the differential output modes are performed, the zero reset cannot be performed.

Cancel

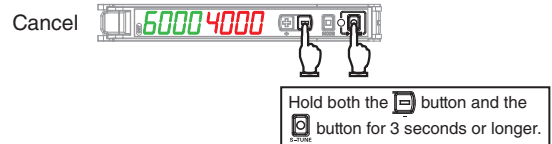



 When released, [0-5L OFF] is displayed.
The threshold also changes accordingly. The lower threshold limit is -1999.

For Stable Detection Regardless of Received Light Intensity Changed due to Dust or Dirt

• DPC Function (Dynamic Power Control)

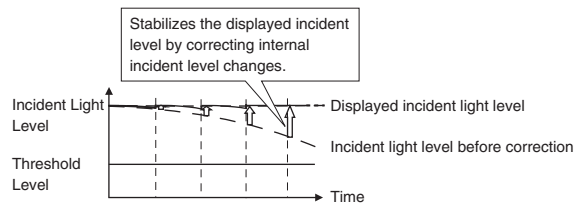
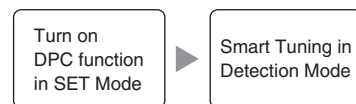
Use this function with through-beam type or regressive reflection type.



 Set output switching to D-ON (Dark ON). When power tuning ON / OFF setting is OFF, Smart Tuning is in error or maximum sensitivity tuning is executed, the DPC function is disabled.

DPC function does not work depending on the setting.
When the Smart Tuning indicator is lit up and the DPC function is set to ON, the DPC function works.

 If the threshold level must be changed according to the change in the received light intensity, the ATC Function (Active Threshold Control) can be used instead. (Make the ratio of the received light intensity to the threshold level constant.)
The ATC function is enabled when the DPC function is set to ATC in the SET Mode and the Smart Tuning is executed in the Detection Mode. Other restrictions conform to those for the DPC function.

- Threaded
- Hex-shaped
- Cylindrical

- Flat
- Sleeved

- Small Spot
- High Power
- Narrow view

BGS

- Retro-reflective
- Limited-reflective

- Chemical-resistant, Oil-resistant
- Bending
- Heat-resistant

Area Detection

- Liquid-level
- Vacuum
- FPD, Semi, Solar

Detailed Settings

Hold button for 3 seconds or longer to enter SET mode. SET mode provides the following function settings. Contents on the leftmost side of each item (thick-frame parts) are factory defaults.

Press and hold the button for 3 seconds or longer in the setting mode to switch to the detection mode.

- Output Switching** Switching between Light ON (L-ON) and Dark ON (D-ON)
 - L-on (Light ON)
 - d-on (Dark ON)
- Detection Function** Changing Light Level and Response Time

Detection function	HS	STND	GIGA	SHS
Response time	250µs	1ms	16ms	50µs
Light quantity	1 (reference)	x1	x8	x0.24

(Incident Light Level Example)

HS High-speed Mode: **HS 100**

STND Standard Mode: **Stnd 100**

GIGA Giga Mode: **GIGA 800**

SHS Super High-speed Mode: **SHS 24**

The response time differs when the mutual interference prevention function is enabled. Please check 10. Mutual Interference Prevention Function.
- Setting Initialization** Initializing all settings to factory-set defaults
 - rSt no (Setting initialization)
 - rSt YES (Setting initialization selected)
 - ini ok (Setting initialization completed and then switch to the detection mode)

Long-press the button for 7 seconds or longer in the Detection Mode to set this function.
- Selection of EASY / PRO Mode** Changing settings of 5 to 16
 - EASY Mode
 - Pro Mode

Function Selection: [EASY] / [Pro]
- Delay Timer Function** Setting Output Timer
 - dELy toff (Time Off)
 - dELy offd (Off-delay Timer)
 - dELy on-d (On-delay Timer)
 - dELy SHot (One shot)

After pressing the button, Use the button to set the time. (1 to 9999 ms in 1 ms steps; the initial value: 10 ms Error range: 0.2 ms)

For ZV6M / ZV8M: (0.1 to 0.5ms in 0.1 ms steps; 0.5 to 5ms in 0.5 ms steps; 5 to 9999 ms in 1 ms steps; the initial value: 10 ms Error range: 0.1 ms)
- Power Tuning ON / OFF Setting** To Turn ON / OFF the Light Amount Adjustment at Smart Tuning
 - PtUn on (Power tuning adjustment ON)
 - PtUn Pon (Power tuning setting on power-up ON)
 - PtUn off (Power tuning adjustment OFF)
- Power Tuning Level** Changing the Target Incident Light Level (Power Tuning Level)
 - P-Lw 9999 (Use the button to set the power tuning level. [100 to 9999 in 1 steps; the initial value: 9999])
- Percentage Tuning** Detecting Transparent or Microscopic object
 - PEr off (Percentage tuning OFF)
 - PEr on (Percentage tuning ON)

Press the button in [PEr on] menu, then use the button to set the percentage tuning level. (-99% to 99% in 1% steps; the initial value: -6%)
- DPC Function** Stable Detection Regardless of Incident Light Level Change
 - dPC off (DPC OFF)
 - dPC on (DPC ON)
 - dPC AtC (ATC (Function) ON)
- Mutual Interference Prevention Function** Installing multiple Fiber Heads next to each other
 - FrE9 off (Mutual interference prevention function OFF)
 - FrE9 on (Unit Number Priority Mode)
 - FrE9FASt (Response Time Priority Mode)

When 4 units installed next to each other

When up to 3 units installed next to each other

Emission cycle settings 1 to 4

Set the first unit, the second unit, the third unit and the fourth unit to [o-F1], [o-F2], [o-F3] and [o-F4], respectively.

Response time is as follows:

Emission Cycle Setting	Detection Function HS	Detection Function STND
o-F1 to o-F4 (4 Units)	700 µs	1.6 ms

Emission cycle settings 1 to 3

Set the first unit, the second unit and the third unit to [F-F1], [F-F2] and [F-F3], respectively.

Response time is as follows:

Emission Cycle Setting	Detection Function HS
F-F1 to F-F2 (2 Units)	350 µs
F-F1 to F-F3 (3 Units)	400 µs

Variation in received light intensity when multiple Fiber Heads are installed next to each other is reduced by setting emission cycles for each amplifier. It is not necessary to install fiber amplifiers in close contact with each other. The Unit Number Priority Mode and the Response Time Priority Mode cannot be mixed. In the Unit Number Priority Mode, set the detection function to HS / STND, and, in the Response Time Priority Mode, to HS. Furthermore, set the output mode to other than the differential output mode.

- Output Mode** Changing Output Mode
 - oUt Std (Normal detection mode)
 - oUt d1 F1 (Differential output mode 1, Response time: 250 µs)
 - oUt d1 F2 (Differential output mode 2, Response time: 500 µs)
 - oUt d1 F3 (Differential output mode 3, Response time: 1 ms)
 - oUt d1 F4 (Differential output mode 4, Response time: 10 ms)
 - oUt d1 F5 (Differential output mode 5, Response time: 100 ms)
- External input** Changing the type of external input (External input models only.)
 - in off (Input OFF)
 - in tUNE (Tuning)
 - in PtUn (Power Tuning)

Hidden if standby "Stby" is selected for 16. Eco Function.

The signal input times for tuning "tUNE" are as follows.

	Point 1	Point 2
2-point Tuning	Less than 3 seconds	Less than 3 seconds
Maximum Sensitivity Tuning	3 seconds or more and less than 7 seconds	-
Full Auto Tuning	7 seconds or more	-
Position Tuning	Less than 3 seconds	3 seconds or more

3 seconds or more tuning is ON, Percentage Tuning will be executed. The next operation will not be accepted until tuning is complete.
- Emission Level Adjustment Function** Increasing / decreasing emission power
 - L 100 9999 (Emission Level)

(The red digital display shows the incident light level.) The emission level can be increased / decreased with the button. (L100 to 1. Initial value: L100)

The emission level is updated when Smart Tuning is executed. The emission level can also be adjusted by increasing / decreasing it after Smart Tuning using the emission level adjustment function. However, since the light receiving sensitivity cannot be changed, the result of Smart Tuning cannot be reproduced. Depending on your environment, it may not work properly when the emission level is set low.

The emission level alone can be set by long-pressing both the button and the button for 3 seconds or longer in the Detection Mode.
- Digital Display** Changing Digital Display in RUN Mode for Specific Purpose
 - di SP Std (Threshold / Receiving light amount)
 - di SP PEr (To see the reserve of the light intensity level for the threshold)
 - di SP P-b (To set the threshold with a microscopic object or fast-moving object)
 - di SP bARr (To see the intuitive and easy to follow display)
 - di SP FrE9 (To know the setting state of the mutual interference prevention function)
 - di SP PEARL (To adjust the beam)

(Display Example)

(a) Threshold: 2000, Receiving light amount: 150P

(b) Peak receiving light amount: 8000, Receiving light amount: 2000

(c) Threshold: 100%, Receiving light amount: 100%

(d) Peak receiving light amount: 3500, Receiving light amount: 3000

(e) Emission cycle setting: F-F 19999

When 11. Output Mode is Differential output modes, (a), (b), (c) and (d) cannot be used.
- Inverted Display** Mounting Amplifier in Inverted Direction The display reverses.
 - rEw off (Normal)
 - uo n3j (Reverse)

Threshold and light intensity are displayed on green digital and red digital respectively.
- Eco Function** Saving Power Consumption
 - ECo off (Eco function OFF)
 - ECo on (Eco function ON)
 - ECo Stby (Eco function Standby)

(a) The indicators (green digital and red digital) turn OFF. They turn ON for approx. 10 seconds and then turn OFF by button operation.

(b) The following state is entered during external signal input.

 - Display goes off (the segment of the fourth digit of the threshold value lights in sequence)
 - Emission stops
 - Output turns OFF (for both L-ON and D-ON)
 - "Stby" lights up for approx. 10 seconds by button operation

This can be selected when 12. External Input is "off".
- User Save / Reset Functions** Saving / Reading Settings
 - USEr no (User Save / Reset)
 - USEr SAve (User Save (Saving of settings))
 - USEr rSt (User Reset (Reading of settings))
 - SAve ok (User Save successful)
 - rSt ok (User Reset successful)

All the settings including Smart Tuning results are saved with the user save function. Contents saved by the user save function are not cleared by the setting initialization.

Fiber Sensor Features

Selection Guide

Fiber Units

Threaded
Hex-shaped
Cylindrical

Standard Installation
Saving Space
Flat
Sleeved

Small Spot
High Power

Beam Improvements
Narrow view
BGS

Transparent Objects
Retro-reflective
Limited-reflective

Environmental Immunity
Chemical-resistant, Oil-resistant
Bending
Heat-resistant

Area Detection
Liquid-level

Vacuum
Applications

Installation Information

Fiber Amplifiers, Communications Unit, and Accessories

Technical Guide and Precautions

Model Index

- Threaded
- Hex-shaped
- Cylindrical

- Flat
- Sleeved

- Small Spot
- High Power
- Narrow view
- BGS

- Retro-reflective
- Limited-reflective

- Chemical-resistant, Oil-resistant
- Bending
- Heat-resistant

- Area Detection
- Liquid-level
- Vacuum

Ratings and Specifications

Wire-saving Connectors

Item	Type	Master Connector		Slave Connector	
	Models	E3X-CN21	E3X-CN11	E3X-CN22	E3X-CN12
Number of conductors		4	3	2	1
Diameter of cable		4 dia.			2.6 dia.
Rated current		2.5A			
Rated voltage		50VDC			
Contact resistance		20 mΩ max. (20 mVDC max., 100 mA max.) (The above figure is for connection to the Amplifier Unit and the adjacent Connector. It does not include the conductor resistance of the cable.)			
Number of insertions		Destruction: 50 times (for connection to the Amplifier Unit and the adjacent Connector)			
Material	Housing	Polybutylene terephthalate (PBT)			
	Contact	Phosphor bronze/gold-plated nickel			
Weight (packed state)		Approx. 55 g			Approx. 25 g

Sensor I/O Connectors

Item	Models	XS3F-M42□-40□-A
Number of conductors		4
Diameter of cable		4 dia.
Rated current		1A
Rated voltage		125VDC
Contact resistance		40 mΩ max. (20 mVDC max., 100 mA max.)
Number of insertions		Destruction: 200 times

Dimensions

(Unit: mm)
Tolerance class IT16 applies to demmensions in this date sheet unless otherwise specified.

Wire-saving Connectors (for Models with Wire-saving Connectors)

Master Connector

94-A E3X-CN21
E3X-CN11

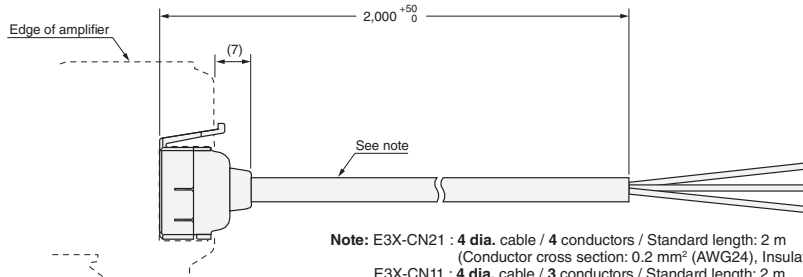

Note: E3X-CN21 : 4 dia. cable / 4 conductors / Standard length: 2 m
(Conductor cross section: 0.2 mm² (AWG24), Insulator diameter: 1.1 mm)
E3X-CN11 : 4 dia. cable / 3 conductors / Standard length: 2 m
(Conductor cross section: 0.2 mm² (AWG24), Insulator diameter: 1.1 mm)

Slave Connector

94-B E3X-CN22
E3X-CN12

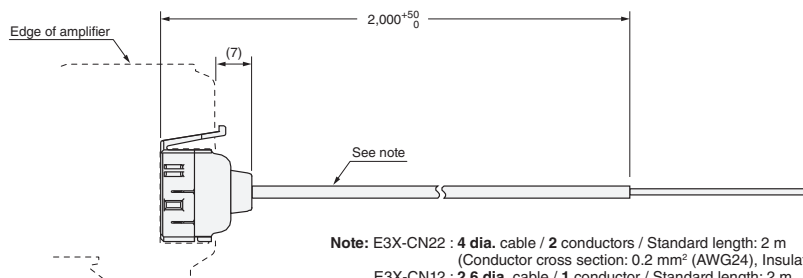

Note: E3X-CN22 : 4 dia. cable / 2 conductors / Standard length: 2 m
(Conductor cross section: 0.2 mm² (AWG24), Insulator diameter: 1.1 mm)
E3X-CN12 : 2.6 dia. cable / 1 conductor / Standard length: 2 m
(Conductor cross section: 0.2 mm² (AWG24), Insulator diameter: 1.1 mm)

Sensor I/O Connectors (for Models with M8 Connectors)

94-C XS3F-M421-402-A
XS3F-M421-405-A

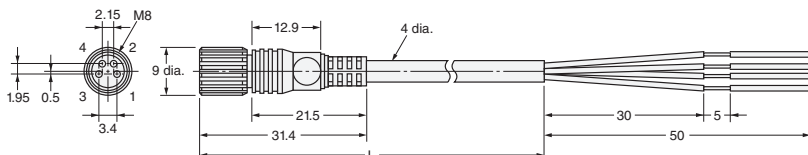

94-D XS3F-M422-402-A
XS3F-M422-405-A

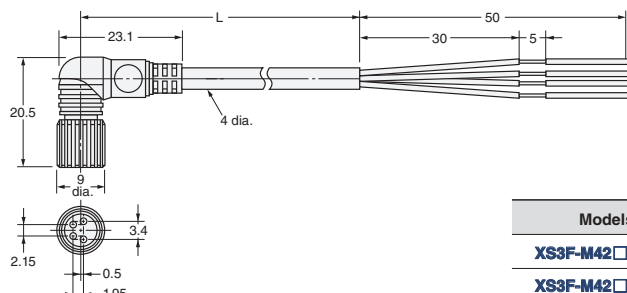

Models	Cable length L (m)
XS3F-M42□-402-A	2
XS3F-M42□-405-A	5

Mounting Brackets

95-A E39-L143

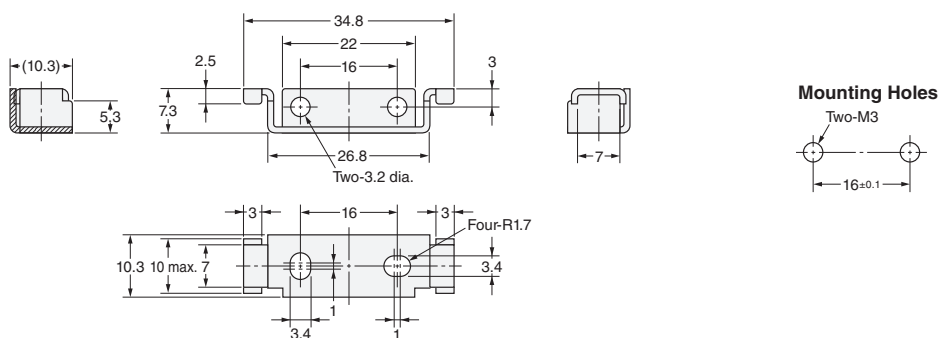
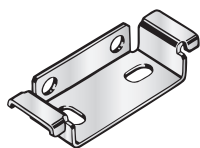

Material: Stainless steel (SUS304)

DIN track

95-B PFP-100N
PFP-50N

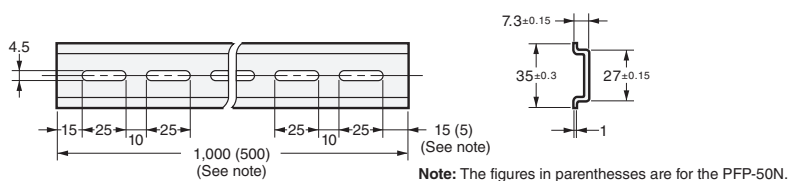

Material: Aluminum

95-C PFP-100N2

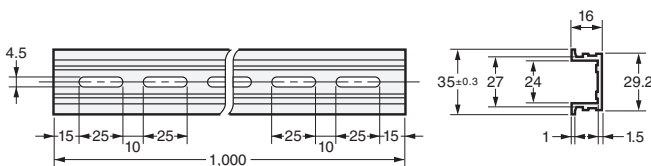

Material: Aluminum

End Plate

95-D PFP-M

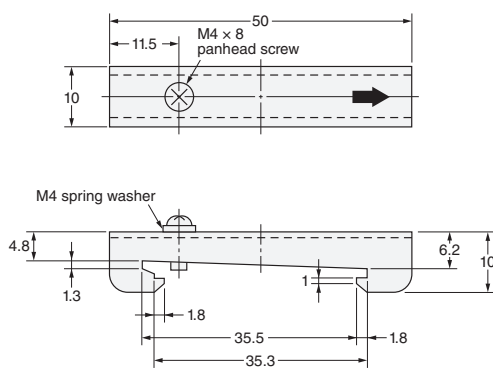

Material: Iron, zinc plating

Fiber Sensor Features

Selection Guide

Fiber Units

Threaded
Hex-shaped
Cylindrical

Standard Installation

Flat
Sleeved

Saving Space

Small Spot
High Power

Beam Improvements

Narrow view
BGS

Beam Improvements

Retro-reflective
Limited-reflective

Transparent Objects

Chemical-resistant, Oil-resistant
Bending

Environmental Immunity

Heat-resistant
Area Detection

Environmental Immunity

Liquid-level
Vacuum

Applications

FPD, Semi, Solar

Applications

Installation Information

Fiber Amplifiers, Communications Unit, and Accessories

Technical Guide and Precautions

Model Index

Reference Information for Fiber Units

Influence of Fiber Cable Length

The sensing distance listed in the Fiber Units specifications are based on the fiber cable lengths found in the suffix of the model number. The sensing distance will change if the fiber cable is cut or extended. The following graph shows the percentage change of the various fiber cable length, where 100% is the sensing distance for a fiber cable with a length of 2 m. Use this as a guideline for installation distances. Keep in mind that extending the cable with a fiber connector will result in even shorter sensing distances than the value given in the graph.

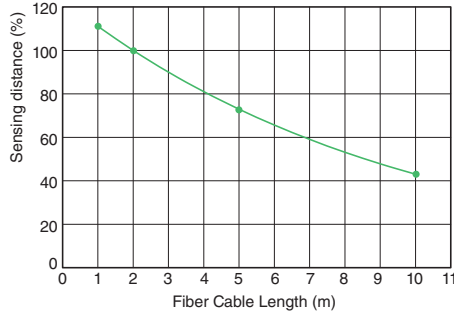

* The 100% value is for a fiber cable with a length of 2 m (same for Through-beam and Reflective Models).

Reflective Models: Sensing Distance Ratios by Workpiece Materials

The following graph shows the percentage change of the various workpieces, where 100% is the sensing distance for white paper, the standard sensing object. Refer to the value of the material that looks like your workpiece.

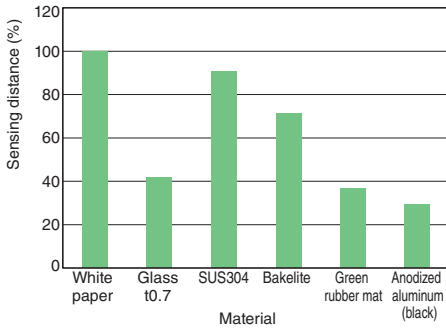

* White paper is 100%.

Types of Fiber Cables

This section describes the features of different types of fiber cables. (This is given in the Fiber Unit specifications as either Flexible or Bend-resistant for the cable bending radius, and Coaxial for the appearance. If no definition is given, a standard cable is used.)

● Flexible Fibers

The flexible fiber has a small bending radius for easy routing without easily breaking. It is easy to use because the cable can be bent without significantly reducing light intensity.

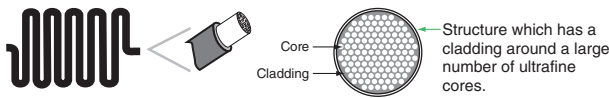

● Break-resistant Fibers

This fiber is resistant to repeated bends for use on moving parts.

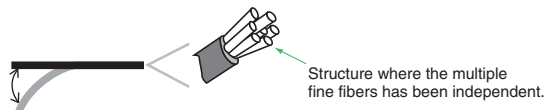

● Standard Fibers

This fiber have a large bending radius compared with bend-resistant or flexible fiber. Use this fiber where the bending radius is large, or on non-moving parts.

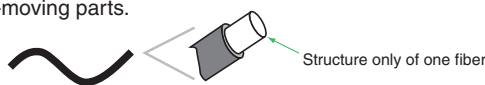

● Coaxial Reflective Fibers

These fibers are suitable for sensing small objects at close range.

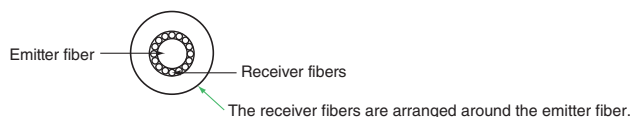

Q&A

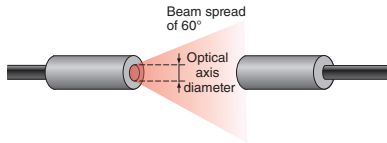
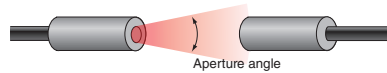
Category	Question	Answer
Fiber Units	How do I interpret the optical axis diameter in the Fiber Unit specifications?	<p>The optical axis diameter is the beam size that the Through-beam Fiber Unit uses for detection.</p> <p>If you are detecting objects larger than the optical axis diameter, you can expect stable detection performance because the object will block all of the beams of light that are used for detection.</p> <p>The incident level may fluctuate, however, if the workpiece passes the beam at high speed.</p> <p>In this case, it is best to select a Fiber Unit with a smaller optical axis diameter, or change the response time of the Fiber Amplifier Unit to High-speed mode or to Super-high-speed mode setting.</p> 
	Are there any differences between the Fiber Units that are used for emitter and receiver?	<p>With Through-beam Fiber Units, there is no difference between emitter fibers and receiver fibers.</p> <p>With Reflective Fiber Units, the emitter fibers and receiver fibers are different on Coaxial Reflective Models.</p> <p>Emitter fiber cables have identification marks. Refer to the individual dimensions diagrams of Fiber Units for details.</p>
	What size must the hole be to mount a Threaded or Cylindrical Fiber Unit?	Refer to the recommended mounting hole dimensions given on pages 58 to 61.
	Are Fiber Cables available in different lengths?	Some models are available with either 5-m or 10-m cable. Ask your OMRON representative for details.
	What is the aperture angle?	<p>The aperture angle is the angle at which the emitter beam spreads out.</p> 
	Are these Fiber Units CE certified?	Fiber Units do not have any electrical components and therefore are exempt from CE certification.
	Can these Fiber Units be used in explosionproof areas?	Explosion-proof certification has not been obtained. Depending on the country in which the Fiber Units are used and how they are used, certification may be required. Check the relevant laws and regulations before use.
Fiber Amplifier Units	<p><small>Built-in Lenses</small></p> <p>What the Fiber Units with built-in lenses?</p>	These highly recommended Fiber Units have built-in lenses that achieve stable detection with high-power beams.
	Can the Fiber Amplifier Unit be operated from a mobile console?	Mobile consoles cannot be used with either the E3NX-FA Series or the E3X-ZV Series.
	Can a Sensor Communications Unit be used?	If you use E3NX-FA0 Amplifier Units, you can use the E3NW-ECT(EtherCAT), E3NW-CRT(CompoNet) or E3NW-CCL(CC-Link).

Fiber Sensor Features

Selection Guide

Fiber Units

Threaded	Standard Installation
Hex-shaped	
Cylindrical	
Flat	Saving Space
Sleeved	
Small Spot	Beam Improvements
High Power	
Narrow view	
BGS	Transparent Objects
Retro-reflective	
Limited-reflective	
Chemical-resistant, Oil-resistant	Environmental Immunity
Bending	
Heat-resistant	
Area Detection	Applications
Liquid-level	
Vacuum	
FPD, Semi, Solar	

Installation Information

Fiber Amplifiers, Communications Unit, and Accessories

Technical Guide and Precautions

Model Index

For common precautions, refer to www.ia.omron.com

Fiber Amplifier Unit

Warning

This product is not designed or rated for ensuring safety of persons either directly or indirectly. Do not use it for such purposes.



Do not use the product with voltage in excess of the rated voltage. Excess voltage may result in malfunction or fire.



Never use the product with AC power supply. Otherwise, explosion may result.



Precautions for Safe Use

The following precautions must be observed to ensure safe operation of the product. Doing so may cause damage or fire.

- (1) Do not install the product in the following locations.
 - Locations subject to direct sunlight
 - Locations subject to condensation due to high humidity
 - Locations subject to corrosive gas
 - Locations subject to vibration or mechanical shocks exceeding the rated values
 - Locations subject to exposure to water, oil, chemicals
 - Locations subject to stream
 - Locations subjected to strong magnetic field or electric field
- (2) Do not use the product in environments subject to flammable or explosive gases.
- (3) Do not use the product in any atmosphere or environment that exceeds the ratings.
- (4) To secure the safety of operation and maintenance, do not install the product close to high-voltage devices and power devices.
- (5) High-Voltage lines and power lines must be wired separately from this product. Wiring them together or placing them in the same duct may cause induction, resulting in malfunction or damage.
- (6) Do not apply load exceeding the ratings. Otherwise, damage or fire may result.
- (7) Do not short the load. Otherwise, damage or fire may result.
- (8) Connect the load correctly.
- (9) Do not miswire such as the polarity of the power supply.
- (10) To use this device as connecting with each other, be sure to connect with the same power supply and turn ON the power simultaneously. Using a separate power supply will influence the functions when connecting the devices to use them.
- (11) Do not use the product if the case is damaged.
- (12) Burn injury may occur. The product surface temperature rises depending on application conditions, such as the ambient temperature and the power supply voltage. Attention must be paid during operation or cleaning.
- (13) When setting the Sensor, be sure to check safety, such as by stopping the equipment.
- (14) Be sure to turn off the power supply before connecting or disconnecting wires.
- (15) Do not attempt to disassemble, repair, or modify the product Unit in any way.
- (16) When disposing of the product, treat it as industrial waste.
- (17) Do not use the Sensor in water, rain, or outdoors.

Precautions for Correct Use

- (1) Be sure to mount the unit to the DIN track until it clicks.
- (2) When using Amplifier Units with Wire-saving Connectors, attach the protective stickers (provided with E3X-CN-series Connectors) on the unused power pins to prevent electrical shock and short circuiting. When using Amplifier Units with Connectors for Communications Units, attach the protective caps (provided with Sensor Communications Unit).
- (3) <E3NX-FA series>

Amplifier Unit with Wire-saving Connector

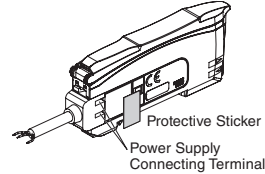

Amplifier Unit with Connector for Communications Unit

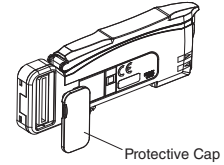

The length for the cable extension must be 30 m or less (or less than 10 m for S-mark certified models).

Be sure to use a cable of at least 0.3 mm² for extension.

The power voltage must be 24 to 30 V when connecting amplifier units with extension cable and wire-saving connector.

<E3X-ZV series>

The length for the cable extension must be 30 m or less.

Be sure to use a cable of at least 0.3 mm² for extension.

- (4) Do not apply the forces on the cord exceeding the following limits: Pull: 40N; torque: 0.1N·m; pressure: 20N; bending: 29.4N
- (5) Do not apply excessive force such as tension, compression or torsion to the Amplifier Unit with the Fiber Unit fixed to the Amplifier Unit.
- (6) Always keep the protective cover in place when using the Amplifier Unit. Not doing so may cause malfunction.
- (7) It may take time until the received light intensity and measured value become stable immediately after the power is turned on depending on use environment.
- (8) The product is ready to operate 250 ms after the power supply is turned ON.
- (9) The Mobile Console E3X-MC11, E3X-MC11-SV2 and E3X-MC11-S cannot be connected.
- (10) Mutual interference prevention on the E3NX-FA Series does not function among the E3X-HD, E3X-DA-S, E3X-DA-N, E3X-SD, or E3X-NA Fiber Amplifier Units. The mutual interference prevention function on the E3X-ZV/MZV Series works only between the E3X-ZV/MZV Series. Mutual interference prevention on the E3X-HD Series does function among the E3X-DA-S and E3X-MDA Fiber Amplifier Units.
- (11) If the unit receives excessive sensor light, the mutual interference prevention function may not work properly, resulting in malfunction of the unit. In such case, increase the threshold.
- (12) The E3NW-ECT Sensor Communications Unit can be used with the E3NX-FA0, but the E3X-DRT21-S, E3X-CRT, and E3X-ECT Sensor Communications Units cannot be used. The E3X-ZV/MZV Series cannot be used with Sensor Communications Units.
- (13) If you notice an abnormal condition such as a strange odor, extreme heating of the unit, or smoke immediately stop using the product, turn off the power, and consult your dealer.
- (14) Do not use thinner, benzene, acetone, and lamp oil for cleaning.

Threaded
Hex-shaped
Cylindrical

Flat
Sleeved

Small Spot
High Power
Narrow view
BGS

Retro-reflective
Limited-reflective

Chemical-resistant, Oil-resistant
Bending
Heat-resistant

Area Detection
Liquid-level
Vacuum
FPD, Semi, Solar

Mounting the Fiber Amplifier Units

■ Mounting on DIN Track

- Let the hook on the Amplifier Unit's Fiber Unit connection side catch the track and push the unit until it clicks.

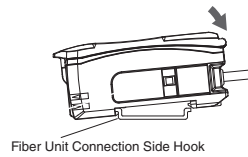

Fiber Unit Connection Side Hook

■ Removing from DIN Track

- Push the unit in the direction 1.
- Lift it up in the direction 2.

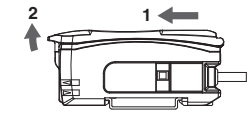

Refer to "I/O Circuit Diagrams" or check the side of the unit for wire color and role indications.

■ Mounting Amplifier Units in Group (Wire-saving Connector Type Models)

- Mount the Fiber Amplifier units one at a time onto the DIN track and push them until they click.
- Slide the Fiber Amplifier units in the direction 2.
- Use End Plates (PFP-M: separately sold) at the both ends of the grouped Fiber Amplifier units to prevent them from separating due to vibration or other cause.
- Tighten the screw on the End Plates using a driver.

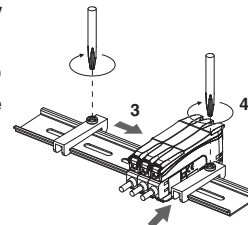
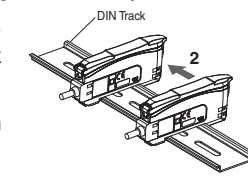

Tighten the screw while pressing the End Plate.

- Under environments such as vibration, use an end plates even with a single Fiber Amplifier Unit.
- The maximum numbers of connectable Amplifier Units are given in the following table.

	Maximum number of interconnected	Maximum number of mutual interference prevention
E3NX-FA series*1	30	10
E3X-ZV/MZV series standard models*1 (E3X-HD11/HD41/HD6/HD8)	16	— *2
E3X-HD0		
With E3X-ECT	30	10
With E3X-CRT	16	10

- If Units are to be connected, the ambient temperature will change with the number of Units that are connected. Check the Ratings and Characteristics specifications.
- Always turn OFF the power before connecting or disconnecting Units.

*1. The mutual interference prevention function cannot be used if the detection mode is set to super-high-speed mode (SHS).

*2. Mutual interference between up to 4 channels can be prevented by setting each Amplifier Unit individually.

Mounting Fiber Units

■ Use Fiber Cutter

Cut a thin fiber as follows.

For standard fibers, insert to the desired cutting position and cut.

(1) The fiber is shipped loosely tightened as shown in the figure at the right	
(2) Adjust the fiber to the desired length and fully tighten.	
(3) Insert the Fiber Unit into E39-F4 and cut it.	
(4) Finished state. (Correctly cut end)	

Note: The insertion direction into the Fiber Amplifier Unit is shown in the above figure.

■ Mount Fiber Unit

- Open the protective cover.
- Raise the lock lever.
- Insert the Fiber Unit in the fiber unit hole to the bottom.
- Return the lock lever to the original position and fix the Fiber Unit.

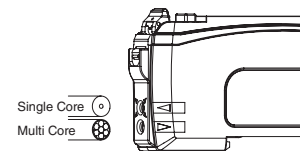
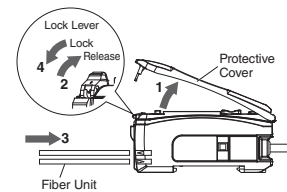

- When mounting a coaxial reflective Fiber Unit, insert the single-core Fiber Unit to the upper hole (Emitter side) and the multi-core Fiber Unit to the lower hole (Receiver side). The cables for the Single-core Fiber Units (Emitters) have identification marks. Refer to the dimensions diagrams for details.

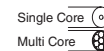

- When removing the Fiber Unit, follow the above steps in reverse order. To maintain the characteristics of the Fiber Unit, make sure the lock is released before removing the Fiber Unit.

- Threaded
- Hex-shaped
- Cylindrical

- Flat
- Sleeved

- Small Spot
- High Power
- Narrow view
- BGS

- Retro-reflective
- Limited-reflective

- Chemical-resistant, Oil-resistant
- Bending
- Heat-resistant

- Area Detection
- Liquid-level
- Vacuum
- FPD, Semi, Solar

Fiber Units

Warning

This product is not designed or rated for ensuring safety of persons either directly or indirectly. Do not use it for such purposes.



Precautions for Correct Use

Do not use the Fiber Unit in atmospheres or environments that exceed product ratings.

Mounting Tightening Force

Refer to pages 62 to 66 for the tightening torque to apply when mounting a Fiber Unit.

<Threaded Models>

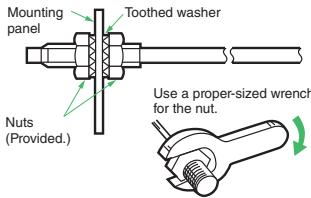

<Cylindrical Models>

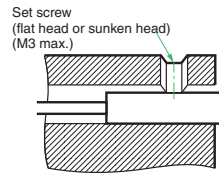

<Chemical and Oil-resistant Models>

The following method is recommended for mounting Fiber Units with fluororesin-covered sensing heads (E32-T□F and E32-D□F) to prevent from cracking the fluororesin case.

If you use a set screw to secure the Fiber Unit, tighten it with care to prevent from cracking the case.

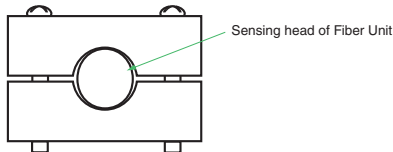

Connections

- Do not subject the Fiber Unit to excessive force, such as tension or compression. Refer to pages 62 to 66 for tensile strengths.
- Make sure any bend in the Fiber Unit is larger than the allowable bending radius. Refer to pages 62 to 66 for bending radius ratings and length of unbendable sections at the base of the Fiber Unit.
- Do not compress or place heavy loads on the fibers.

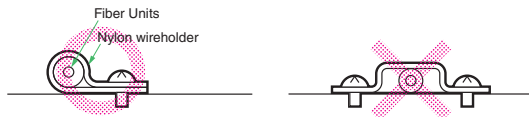

- The method shown below is an effective way to prevent the Fiber Unit from breaking due to vibration.

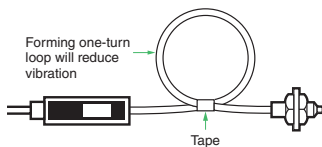

Sleeve Bender (E39-F11)

- The bending radius of the stainless steel tube should be as large as possible. The smaller the bending radius is, the shorter the sensing distance will be.
- Insert the tip of the stainless steel tube in the Sleeve Bender and slowly bend the tube along the curve of the Sleeve Bender.

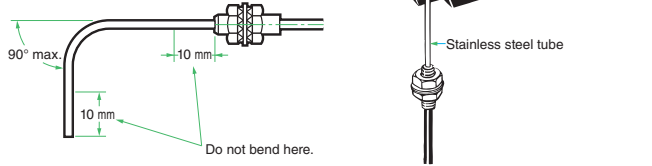

Heat-resistant Fiber Units (E32-D51(R) and E32-T51(R))

The fibers of these Units cannot be extended using the E39-F10 Fiber Connector.

E32-T14

These Units may enter the light-ON state if there are reflective objects at the end of the lenses.

If reflection is a problem, attach the black stickers provided to the ends of the lenses.

E32-T16PR

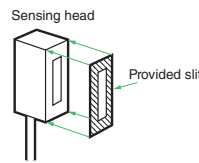

To use the provided slit, peel off the backing sheet, align the slit with the edges of the sensing surface, and attach it to the sensing head.

Use the slit in applications where saturation occurs (i.e., changes in incident level cannot be detected) due to short sensing distances.

Vacuum-resistant Fiber Units (E32-□V)

Although the Flanges, the Fiber Units on the vacuum side, and the Lens Units have been cleaned, as an extra precaution, clean these with alcohol before using them in high-vacuum environments to ensure that they are properly degreased.

Liquid-level Detection Fiber Unit (E32-D82F1)

- Secure the Fiber Unit using the unbendable section. Otherwise, the liquid-level detection position may be displaced.

Liquid-level Detection Fiber Units (Tube-mounting Models)

- Make sure that the tube is not deformed when using a band to secure the Fiber Unit.

Fiber Units

● Adjustment

Detection Position for Liquid-level Detection Fiber Unit (E32-D82F1)

The liquid-level detection position is 5.2 ±2 mm from the end of the fluoro-resin section. (Refer to the diagram on the right.)

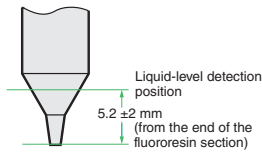

The liquid-level detection position varies with the surface tension of the liquid and the degree of wetness at the Fiber Unit's detection position.

● Other Precautions

Liquid-level Detection Fiber Unit (E32-D82F1)

- Operation may become unstable in the following cases:
 1. Bubbles stick to the cone of the sensing head.
 2. Solute deposits on the cone of the sensing head.
 3. The liquid has a high viscosity.
- There are some liquids, such as milky white liquids, for which detection is not possible.
- Do not let the end of the fluoro-resin section bump into other objects.
Damage to or deformation of the sensing head may cause unstable operation.
- The product shall be used in the following conditions.
Ambient pressure: -50 to +500 kPa
- To use one-point teach mode (without object)
Please carry out teaching where the detecting head is sunk into liquid. The sensitivity is set to 10% upper to the incident level in the liquid. This setting method is effective in high degree of viscosity, because it becomes stable to the fluctuation of incident level when the liquid drops from the tip.
- To use two-point teach mode (with/without object)
Please teach where the detecting head is pulled up from liquid and next teach where it is sunk into liquid. This setting method is effective to a liquid which is easy to bubble at high temperature.
- Don't use maximum sensitivity mode because a liquid may be undetectable.

Chemical and Oil-resistant, Liquid-level Detection Fiber Unit (E32-D82F1)

Fluoro-resin shows strong chemical-resistant properties but is permeable if exposed to atmospheres with gaseous chemicals or water vapors, resulting in failure or damage.

Confirm applicability sufficiently before using the Fiber Unit in these environments.

Accessories

Use of E39-R3 Reflector Provided with E32-R21

1. Use detergent to remove any dust or oil from the surfaces where tape is applied. Adhesive tape will not be attached properly if oil or dust remains on the surface.
2. The E39-R3 cannot be used in areas that are exposed to oil or chemicals.

Mounting method of Disconnection-resistant Protective Spiral Tubes (E39-F32□)

1. Insert the Fiber Unit into the Protective Spiral Tube from the head connector (threaded).

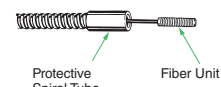

2. Push the fiber into the Protective Spiral Tube. The tube must be straight so that the fiber enters without twisting. Turn the Protective Spiral Tube, not the fiber.

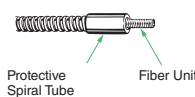

3. Secure the Protective Spiral Tube to the mounting panel with the provided nuts.

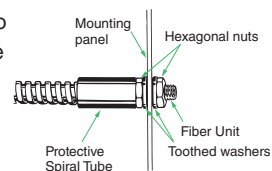

4. Use the provided saddle to secure the end cap of the Protective Spiral Tube.

(To secure the Protective Spiral Tube at a position other than the end cap, apply tape to the tube so that the portion becomes thicker in diameter.)

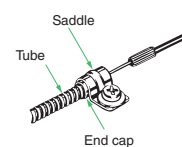

Attaching the E39-F10 Fiber Connector

Attach the Fiber Connector as shown in the following figures.

1. Insert the Fiber Unit in the retention clip.
2. Insert the retention clip into the splice.

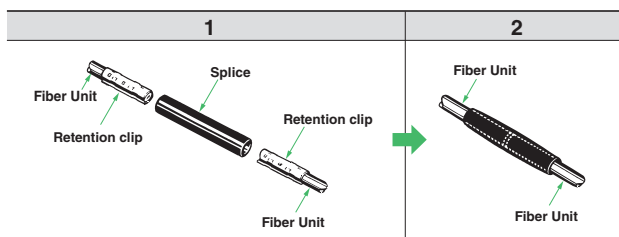

- The Fiber Units should be as close as possible when they are connected.
The sensing distance is reduced by approximately 25% when Fiber Units are extended by the connector.
- Only 2.2-mm-diameter fibers can be connected.

Fiber Sensor Features	
Selection Guide	
Fiber Units	
Threaded	Standard Installation
Hex-shaped	
Cylindrical	
Flat	Saving Space
Sleeved	
Small Spot	Beam Improvements
High Power	
Narrow view	
BGS	Transparent Objects
Retro-reflective	
Limited-reflective	
Chemical-resistant, Oil-resistant	Environmental Immunity
Bending	
Heat-resistant	
Area Detection	Applications
Liquid-level	
Vacuum	
FPD, Semi, Solar	Installation Information
Fiber Amplifiers, Communications Unit, and Accessories	
Technical Guide and Precautions	
Model Index	

Fiber Sensor Features

Selection Guide

Fiber Units

Standard Installation
Threaded
Hex-shaped
Cylindrical

Saving Space
Flat
Sleeved

Small Spot

Beam Improvements
High Power
Narrow view

BGS

Transparent Objects
Retro-reflective
Limited-reflective

Environmental Immunity
Chemical-resistant, Oil-resistant
Bending

Heat-resistant

Applications
Area Detection
Liquid-level

Vacuum
FPD, Semi, Solar

Installation Information

Fiber Amplifiers, Communications Unit, and Accessories

Technical Guide and Precautions

Model Index

Models	Specifications	Dimensions
E32-A		
E32-A01 5M	P.54	P.55 (55-A)
E32-A03 2M	P.34	P.35 (35-A)
	P.60	P.61 (61-A)
E32-A03-1 2M	P.34	P.35 (35-B)
	P.60	P.61 (61-B)
E32-A03-2 2M	P.60	P.61 (61-C)
E32-A04 2M	P.34	P.35 (35-C)
	P.60	P.61 (61-D)
E32-A04-1 2M	P.60	P.61 (61-E)
E32-A04-8 2M	P.60	P.61 (61-F)
E32-A08 2M	P.40	P.41 (41-C)
	P.58	P.59 (59-B)
E32-A08H2 2M	P.50	P.51 (51-D)
	P.58	P.59 (59-C)
E32-A09 2M	P.40	P.41 (41-F)
	P.58	P.59 (59-E)
E32-A09H2 2M	P.50	P.51 (51-G)
	P.58	P.59 (59-F)
E32-A12 2M	P.40	P.41 (41-D)
	P.58	P.59 (59-D)
E32-A13 2M	P.52	P.53 (53-C)
E32-C		
E32-C21N 2M	P.10 (P.24, 26)	P.11 (11-D) (P.25, 27)
E32-C31 2M	P.08 (P.24, 26)	P.09 (09-D) (P.25, 27)
E32-C31M 1M	P.08	P.09 (09-E)
E32-C31N 2M	P.08	P.09 (09-A)
E32-C41 1M	P.26	P.27 (27-A)
		P.27 (27-D)
E32-C42 1M	P.24	P.25 (25-A)
		P.25 (25-B)
E32-C42S 1M	P.24	P.25 (25-E)
E32-CC200 2M	P.08 (P.26)	P.09 (09-H) (P.27)
E32-C91N 2M	P.08	P.09 (09-B)
	P.10	P.11 (11-F)
E32-D		
E32-D11 2M	P.46	P.47 (47-E)
E32-D11R 2M	P.08	P.09 (09-G)
E32-D11U 2M	P.42	P.43 (43-I)
E32-D12F 2M	P.42	P.43 (43-H)
E32-D14LR 2M	P.14	P.15 (15-G)
E32-D15XR 2M	P.18	P.19 (19-A)
E32-D15YR 2M	P.18	P.19 (19-C)
E32-D15ZR 2M	P.18	P.19 (19-E)
E32-D16 2M	P.28	P.29 (29-E)
E32-D21 2M	P.46	P.47 (47-B)
E32-D211R 2M	P.08	P.09 (09-F)
E32-D21B 2M	P.46	P.47 (47-D)
E32-D21N 2M	P.10	P.11 (11-E)
E32-D21R 2M	P.08	P.09 (09-C)
E32-D21-S3 2M	P.22	P.23 (23-J)
E32-D221B 2M	P.14	P.15 (15-D)
	P.46	P.47 (47-C)
E32-D22B 2M	P.14	P.15 (15-A)
	P.46	P.47 (47-A)
E32-D22R 2M	P.14	P.15 (15-C)
E32-D22-S1 2M	P.22	P.23 (23-I)
E32-D24R 2M	P.22	P.23 (23-A)
E32-D24-S2 2M	P.22	P.23 (23-B)
E32-D25XB 2M	P.46	P.47 (47-F)
E32-D25XR 2M	P.18	P.19 (19-B)
E32-D25YR 2M	P.18	P.19 (19-D)

Models	Specifications	Dimensions
E32-D25ZR 2M	P.18	P.19 (19-F)
E32-D25-S3 2M	P.22	P.23 (23-L)
E32-D31-S1 0.5M	P.22	P.23 (23-Q)
E32-D32L 2M	P.14	P.15 (15-E)
E32-D32-S1 0.5M	P.22	P.23 (23-F)
E32-D33 2M	P.14	P.15 (15-F)
	P.22	P.23 (23-E)
E32-D331 2M	P.22	P.23 (23-D)
E32-D36P1 2M	P.52	P.53 (53-F)
E32-D36T 2M	P.54	P.55 (55-C)
E32-D43M 1M	P.14	P.15 (15-B)
	P.22	P.23 (23-C)
E32-D51 2M	P.50	P.51 (51-B)
E32-D51R 2M	P.50	P.51 (51-A)
E32-D61-S 2M	P.50	P.51 (51-I)
E32-D611-S 2M	P.50	P.51 (51-H)
E32-D73-S 2M	P.50	P.51 (51-J)
E32-D81R-S 2M	P.50	P.51 (51-C)
E32-D82F1 4M	P.54	P.55 (55-D)
E32-DC200BR 2M	P.22	P.23 (23-K)
E32-DC200F4R 2M	P.22	P.23 (23-H)
E32-G		
E32-G16 2M	P.52	P.53 (53-E)
E32-L		
E32-L11FP 2M	P.42	P.43 (43-F)
	P.58	P.59 (59-G)
E32-L11FS 2M	P.42	P.43 (43-G)
	P.58	P.59 (59-H)
E32-L15 2M	P.24	P.25 (25-F)
E32-L16-N 2M	P.36	P.37 (37-A)
	P.40	P.41 (41-B)
	P.58	P.59 (59-A)
E32-L24S 2M	P.36	P.37 (37-B)
	P.40	P.41 (41-A)
E32-L25L 2M	P.36	P.37 (37-C)
	P.40	P.41 (41-E)
E32-L25T 2M	P.54	P.55 (55-B)
E32-L64 2M	P.50	P.51 (51-E)
E32-L86 2M	P.50	P.51 (51-F)
E32-LD11 2M	P.08	P.09 (09-I)
E32-LD11N 2M	P.10	P.11 (11-C)
E32-LD11R 2M	P.08	P.09 (09-I)
E32-LR11NP 2M	P.38	P.39 (39-A)
	P.10	P.11 (11-G)
E32-LT11 2M	P.06	P.07 (07-C)
	P.28	P.29 (29-C)
E32-LT11N 2M	P.18	P.19 (29-A)
	P.20	P.21 (11-A)
E32-LT11R 2M	P.06	P.07 (07-C)
	P.28	P.29 (29-C)
E32-LT35Z 2M	P.16	P.17 (17-G)
E32-R		
E32-R16 2M	P.38	P.39 (39-B)
E32-R21 2M	P.38	P.39 (39-C)
E32-T		
E32-T10V 2M	P.56	P.57 (57-D)
E32-T11 2M	P.44	P.45 (45-C)
E32-T11F 2M	P.42	P.43 (43-C)
E32-T11N 2M	P.06	P.07 (07-A)
	(P.30)	(P.31)
E32-T11NF 2M	P.42	P.43 (43-A)
E32-T11NFS 2M	P.42	P.43 (43-A2)
E32-T11R 2M	P.06	P.07 (07-B)
	(P.30)	(P.29, 31)

Models	Specifications	Dimensions
E32-T12F 2M	P.42	P.43 (43-B)
E32-T12R 2M	P.12	P.13 (13-C)
E32-T14 2M	P.28	P.29 (29-D)
E32-T14F 2M	P.42	P.43 (43-D)
E32-T14LR 2M	P.12	P.13 (13-D)
E32-T15XR 2M	P.16	P.17 (17-A)
E32-T15YR 2M	P.16	P.17 (17-C)
E32-T15ZR 2M	P.16	P.17 (17-E)
E32-T16JR 2M	P.52	P.53 (53-B)
E32-T16PR 2M	P.52	P.53 (53-A)
E32-T16WR 2M	P.52	P.53 (53-D)
E32-T17L 10M	P.28	P.29 (29-B)
E32-T21 2M	P.44	P.45 (45-B)
E32-T21-S1 2M	P.20	P.21 (21-D)
E32-T223R 2M	P.12	P.13 (13-A)
E32-T22B 2M	P.12	P.13 (13-B)
	P.44	P.45 (45-A)
E32-T22S 2M	P.34	P.35 (35-F)
E32-T24E 2M	P.20	P.21 (21-B)
E32-T24R 2M	P.20	P.21 (21-A)
E32-T24S 2M	P.34	P.35 (35-E)
	P.60	P.61 (61-H)
E32-T24SR 2M	P.34	P.35 (35-D)
	P.60	P.61 (61-G)
E32-T25XB 2M	P.44	P.45 (45-D)
E32-T25XR 2M	P.16	P.17 (17-B)
E32-T25YR 2M	P.16	P.17 (17-D)
E32-T25ZR 2M	P.16	P.17 (17-F)
E32-T33 1M	P.20	P.21 (21-C)
E32-T51 2M	P.48	P.49 (49-B)
	(P.32)	(P.33)
E32-T51F 2M	P.42	P.43 (43-E)
E32-T51R 2M	P.48	P.49 (49-A)
	(P.32)	(P.33)
E32-T51V 1M	P.56	P.57 (57-A)
E32-T54 2M	P.48	P.49 (49-C)
E32-T61-S 2M	P.48	P.49 (49-G)
	(P.32)	(P.33)
E32-T64-2 2M	P.48	P.49 (49-F)
E32-T81R-S 2M	P.48	P.49 (49-D)
	(P.32)	(P.33)
E32-T84SV 1M	P.56	P.57 (57-C)
E32-T84S-S 2M	P.48	P.49 (49-E)
E32-TC200BR 2M	P.20	P.21 (21-E)
E32-V		
E32-VF1	P.56	P.57 (57-F)
E32-VF4	P.56	P.57 (57-E)
E39-F		
E39-F1	P.30, 32	P.30 (30-A)
E39-F1-33	P.32	P.32 (32-D)
E39-F11	P.21	—
E39-F16	P.30, 32	P.30 (30-B)
E39-F17	P.24	P.25 (25-B)
E39-F18	P.26	P.27 (27-G)
		P.27 (27-H)
E39-F1V	P.56	P.57 (57-B)
E39-F2	P.30, 32	P.30 (30-C)
E39-F32A 1M	P.46	P.47 (47-G)
E39-F32C 1M	P.44	P.45 (45-E)
	P.46	P.47 (47-G)
E39-F32D 1M	P.46	P.47 (47-G)
E39-F3A	P.24	P.25 (25-A)
E39-F3A-5	P.26	P.27 (27-A)
		P.27 (27-B)
		P.27 (27-C)

Models	Specifications	Dimensions
E39-F3B	P.26	P.27 (27-D)
		P.27 (27-E)
		P.27 (27-F)
E39-F3C	P.24	P.25 (25-C)
		P.25 (25-D)
E39-R		
E39-R1	—	P.39 (39-B)
E39-R3	—	P.39 (39-C)
E39-RP1	P.38	P.39 (39-A)
	P.10	P.11 (11-G)
E39-RP37	P.39	—
E39-RSP1	P.39	—
E39-L		
E39-L143	—	P.95 (95-A)
E3NW		
E3NW-DS	P.84	P.85 (85-B)
E3NW-ECT	P.84	P.85 (85-A)
E3NX-FA		
E3NX-FA0	P.74	P.77 (77-B)
E3NX-FA10 2M	P.74	P.77 (77-B)
E3NX-FA11 2M	P.72	P.76 (76-A)
E3NX-FA11-5 2M	P.72	P.76 (76-A)
E3NX-FA11AN 2M	P.72	P.76 (76-A)
E3NX-FA21 2M	P.72	P.76 (76-A)
E3NX-FA24	P.72	P.77 (77-A)
E3NX-FA40 2M	P.74	P.77 (77-B)
E3NX-FA41 2M	P.72	P.76 (76-A)
E3NX-FA41AN 2M	P.74	P.76 (76-A)
E3NX-FA51 2M	P.72	P.76 (76-A)
E3NX-FA54	P.72	P.77 (77-A)
E3NX-FA54TW	P.72	P.77 (77-A)
E3NX-FA6	P.72	P.76 (76-B)
E3NX-FA7	P.72	P.76 (76-B)
E3NX-FA7TW	P.72	P.76 (76-B)
E3NX-FA8	P.72	P.76 (76-B)
E3NX-FA9	P.72	P.76 (76-B)
E3NX-FA9TW	P.72	P.76 (76-B)
E3NX-FAH0	P.74	P.77 (77-B)
E3NX-FAH11 2M	P.72	P.76 (76-A)
E3NX-FAH41 2M	P.72	P.76 (76-A)
E3NX-FAH6	P.72	P.76 (76-B)
E3NX-FAH8	P.72	P.76 (76-B)
E3X-CN		
E3X-CN11	P.94	P.94 (94-A)
E3X-CN12	P.94	P.94 (94-B)
E3X-CN21	P.94	P.94 (94-A)
E3X-CN22	P.94	P.94 (94-B)
E3X-ZV		
E3X-ZV11 2M	P.88	P.89 (89-A)
E3X-ZV41 2M	P.88	P.89 (89-A)
E3X-ZV6	P.88	P.89 (89-B)
E3X-ZV8	P.88	P.89 (89-B)
PFP		
PFP-100N	—	P.95 (95-B)
PFP-100N2	—	P.95 (95-C)
PFP-50N	—	P.95 (95-B)
PFP-M	—	P.95 (95-D)
XS3F		
XS3F-M421-402-A	P.94	P.94 (94-C)
XS3F-M421-405-A	P.94	P.94 (94-C)
XS3F-M422-402-A	P.94	P.94 (94-D)
XS3F-M422-405-A	P.94	P.94 (94-D)

Terms and Conditions Agreement

Read and understand this catalog.

Please read and understand this catalog before purchasing the products. Please consult your OMRON representative if you have any questions or comments.

Warranties.

(a) Exclusive Warranty. Omron's exclusive warranty is that the Products will be free from defects in materials and workmanship for a period of twelve months from the date of sale by Omron (or such other period expressed in writing by Omron). Omron disclaims all other warranties, express or implied.

(b) Limitations. OMRON MAKES NO WARRANTY OR REPRESENTATION, EXPRESS OR IMPLIED, ABOUT NON-INFRINGEMENT, MERCHANTABILITY OR FITNESS FOR A PARTICULAR PURPOSE OF THE PRODUCTS. BUYER ACKNOWLEDGES THAT IT ALONE HAS DETERMINED THAT THE PRODUCTS WILL SUITABLY MEET THE REQUIREMENTS OF THEIR INTENDED USE.

Omron further disclaims all warranties and responsibility of any type for claims or expenses based on infringement by the Products or otherwise of any intellectual property right. (c) Buyer Remedy. Omron's sole obligation hereunder shall be, at Omron's election, to (i) replace (in the form originally shipped with Buyer responsible for labor charges for removal or replacement thereof) the non-complying Product, (ii) repair the non-complying Product, or (iii) repay or credit Buyer an amount equal to the purchase price of the non-complying Product; provided that in no event shall Omron be responsible for warranty, repair, indemnity or any other claims or expenses regarding the Products unless Omron's analysis confirms that the Products were properly handled, stored, installed and maintained and not subject to contamination, abuse, misuse or inappropriate modification. Return of any Products by Buyer must be approved in writing by Omron before shipment. Omron Companies shall not be liable for the suitability or unsuitability or the results from the use of Products in combination with any electrical or electronic components, circuits, system assemblies or any other materials or substances or environments. Any advice, recommendations or information given orally or in writing, are not to be construed as an amendment or addition to the above warranty.

See <http://www.omron.com/global/> or contact your Omron representative for published information.

Limitation on Liability; Etc.

OMRON COMPANIES SHALL NOT BE LIABLE FOR SPECIAL, INDIRECT, INCIDENTAL, OR CONSEQUENTIAL DAMAGES, LOSS OF PROFITS OR PRODUCTION OR COMMERCIAL LOSS IN ANY WAY CONNECTED WITH THE PRODUCTS, WHETHER SUCH CLAIM IS BASED IN CONTRACT, WARRANTY, NEGLIGENCE OR STRICT LIABILITY.

Further, in no event shall liability of Omron Companies exceed the individual price of the Product on which liability is asserted.

Suitability of Use.

Omron Companies shall not be responsible for conformity with any standards, codes or regulations which apply to the combination of the Product in the Buyer's application or use of the Product. At Buyer's request, Omron will provide applicable third party certification documents identifying ratings and limitations of use which apply to the Product. This information by itself is not sufficient for a complete determination of the suitability of the Product in combination with the end product, machine, system, or other application or use. Buyer shall be solely responsible for determining appropriateness of the particular Product with respect to Buyer's application, product or system. Buyer shall take application responsibility in all cases.

NEVER USE THE PRODUCT FOR AN APPLICATION INVOLVING SERIOUS RISK TO LIFE OR PROPERTY OR IN LARGE QUANTITIES WITHOUT ENSURING THAT THE SYSTEM AS A WHOLE HAS BEEN DESIGNED TO ADDRESS THE RISKS, AND THAT THE OMRON PRODUCT(S) IS PROPERLY RATED AND INSTALLED FOR THE INTENDED USE WITHIN THE OVERALL EQUIPMENT OR SYSTEM.

Programmable Products.

Omron Companies shall not be responsible for the user's programming of a programmable Product, or any consequence thereof.

Performance Data.

Data presented in Omron Company websites, catalogs and other materials is provided as a guide for the user in determining suitability and does not constitute a warranty. It may represent the result of Omron's test conditions, and the user must correlate it to actual application requirements. Actual performance is subject to the Omron's Warranty and Limitations of Liability.

Change in Specifications.

Product specifications and accessories may be changed at any time based on improvements and other reasons. It is our practice to change part numbers when published ratings or features are changed, or when significant construction changes are made. However, some specifications of the Product may be changed without any notice. When in doubt, special part numbers may be assigned to fix or establish key specifications for your application. Please consult with your Omron's representative at any time to confirm actual specifications of purchased Product.

Errors and Omissions.

Information presented by Omron Companies has been checked and is believed to be accurate; however, no responsibility is assumed for clerical, typographical or proofreading errors or omissions.

N-Smart Amplifier Units
Easy application with consistent operating procedures.

N-Smart
Presence / Detection / Measurement

Applications with Many Sensors:
More convenience and even lower costs with a network.

E3NX-FA Fiber Amplifier Units (Cat. No. E426)
Stable Detection with the No. 1 Performance*

E3NX-CA Color Fiber Amplifier Units (Cat. No. Y216)
High Color Discrimination Capability

E3NC Smart Laser Sensors (Cat. No. E427)
From Minute Workpieces to Long-distance Detection

E3NX-MA Smart Fiber Amplifier Units (2-channel models) (Cat. No. E466)
Space-saving and high performance

E3NW Sensor Communications Units (Cat. No. E428)
EtherCAT, CC-Link V2

E9NC-T Contact-Type Smart Sensors (Cat. No. E433)
Handles Advanced Measurement Applications

E2NC Smart Proximity Sensors (Cat. No. E473)
High-precision sensitivity setting is easy.

E9NC-AA/VA IoT Status Monitoring Amplifiers (Cat. No. E474)
Various condition-monitoring sensors are connected.

* For performance (sensing distance and minimum sensing object) based on November 2017 OMRON investigation.

Smart Fiber Amplifier Units

Please refer to Smart Fiber Amplifier Units Catalog for details.



Smart Fiber Amplifier Units
E3NX-FA Series

Cat. No. E426



Smart Fiber Amplifier Units
E3X-ZV Series

Cat. No. E600

EtherCAT® is a registered trademark and patented technology, licensed by Beckhoff Automation GmbH, Germany.
CC-Link is a registered trademark of Mitsubishi Electric Corporation. The trademark is managed by the CC-Link Partner Association.

Note: Do not use this document to operate the Unit.

OMRON Corporation Industrial Automation Company

Kyoto, JAPAN

Contact : www.ia.omron.com

Regional Headquarters

OMRON EUROPE B.V.

Wegalaan 67-69, 2132 JD Hoofddorp
The Netherlands
Tel: (31) 2356-81-300 Fax: (31) 2356-81-388

OMRON ELECTRONICS LLC

2895 Greenspoint Parkway, Suite 200
Hoffman Estates, IL 60169 U.S.A.
Tel: (1) 847-843-7900 Fax: (1) 847-843-7787

OMRON ASIA PACIFIC PTE. LTD.

438B Alexandra Road, #08-01/02 Alexandra
Technopark, Singapore 119968
Tel: (65) 6835-3011 Fax: (65) 6835-3011

OMRON (CHINA) CO., LTD.

Room 2211, Bank of China Tower,
200 Yin Cheng Zhong Road,
PuDong New Area, Shanghai, 200120, China
Tel: (86) 21-6023-0333 Fax: (86) 21-5037-2388

Authorized Distributor:

©OMRON Corporation 2012-2023 All Rights Reserved.
In the interest of product improvement,
specifications are subject to change without notice.

CSM_20_1

Cat. No. E418-E1-16 1223 (0212)