

## Datasheet

No revision without agency approval.



- Designed for use with approved amplifiers and intrinsically safe barriers in explosive environments
- NAMUR compliant sensors with MINI-BEAM performance and small size
- Output 1 mA or less in the dark condition and 2 mA or more in the light condition
- Models with integral cable or quick-disconnect



### WARNING: Not To Be Used for Personnel Protection

Never use this device as a sensing device for personnel **protection**. Doing so could lead to serious injury or death. This device does not include the self-checking redundant circuitry necessary to allow its use in personnel safety applications. A sensor failure or malfunction can cause either an energized or de-energized sensor output condition.

## Models

Model <sup>1</sup>	Sensing Mode	Sensing Beam	Sensing Range	Output Type
MI9E <b>Emitter</b>	Opposed	Infrared, 880 nm	6 m (20 ft)	Constant Current ≤ 1.2 mA dark ≥ 2.1 mA light
MIAD9R Receiver				
MIAD9LVAG	Polarized Retroreflective	Visible red, 650 nm	50 mm to 2 m (2 in to 7 ft)	
MIAD9LV	Retroreflective	Visible red, 650 nm	5 m (16.4 ft)	
MIAD9D	Diffuse	Infrared, 880 nm	380 mm (15 in)	
MIAD9W	Divergent Diffuse	Infrared, 880 nm	75 mm (3 in)	
MIAD9CV	Convergent	Visible red, 650 nm	16 mm (0.6 in)	
MIAD9CV2			43 mm (1.7 in)	
MIAD9F	Fiber Optic (Glass)	Infrared, 880 nm	Range varies by sensing mode and fiber optics used	

## Overview

MIAD9 Series NAMUR Sensors are small, rugged, self-contained two-wire sensors designed for use with certified intrinsically safe switching amplifiers and barriers (Approved Apparatus) with intrinsically safe circuits. MIAD9 Series NAMUR sensors are designed in accordance with DIN 19234 (IEC/EN 60947-5-6) for operation via two-wire connection to a Approved Apparatus that is controlled by the variable internal resistance of the sensor.

These sensors vary the impedance across the sensor output, which passes 1 mA or less in the "dark" condition and 2 mA or more in the "light" condition. A red LED on the rear of the sensor lights whenever the sensor sees the "light" condition. A rugged, clutched, 15-turn slotted brass screw Gain control potentiometer enables precise adjustment of system sensitivity.

Models are available with either a 2 m (6.5 ft) or 10 m (30 ft) long attached PVC-covered cable, or a 4-pin Euro-style quick disconnect (QD) connector. Quick disconnect models (with "Q" in the model number suffix) use MQD9-4.. mating cable (either straight or right angle connector; see [Quick-Disconnect \(QD\) Cables](#) on page 7). Contact Banner Engineering for availability of sensor models with 10 m (30 ft) long attached cable.

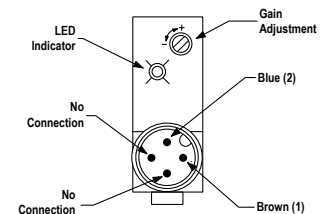

Figure 1. Features (rear of sensor, quick-disconnect model shown)

<sup>1</sup> Only standard 2 m (6.5 ft) cable models are listed. For 4-pin Euro-style Integral QD models: add suffix "Q" to the model number (for example, MIAD9RQ); accessory mating cable required.



## Installation Instructions

### Ex/HazLoc Applications



**WARNING:**

- Explosive Atmospheres/Hazardous **Locations**
- The user has the responsibility to ensure that all local, state, and national laws, rules, codes, or regulations relating to the installation and use of this Banner device in any particular application are satisfied. This Banner device must be installed by Qualified Persons, in accordance with this document and applicable regulations.
- A Qualified Person is a person who, by possession of a recognized degree or certificate of professional training, or who, by extensive knowledge, training and experience, has successfully demonstrated the ability to solve problems relating to the subject matter and work.



**WARNING:**

- Explosion Hazard
- Do not disconnect equipment unless the power has been switched off or the area is known to be non-hazardous.



**CAUTION: Electrostatic Discharge (ESD)**

Special **Conditions** for Safe Use. Parts of the enclosure are non-conducting and may generate an ignition-capable level of ESD. Cleaning of the equipment shall be done only with a damp cloth.

General Notes and **Conditions** for Safe Use:

- See Specifications and Wiring Diagrams for important information concerning entity parameters, permissible locations, electrical connections and certifications.
- In addition to the warning above concerning user responsibility, the installation must comply with the following:
  - All installations must comply with all manufacturer's instructions.
  - U.S. Installations: The relevant requirements of the National Electrical Code® (ANSI/NFPA-70 (NEC®) and when appropriate ANSI/ISA-RP12.06.01 Installation of Intrinsically Safe Systems for Hazardous (Classified) Locations.
  - Canadian Installations: The relevant requirements of the Canadian Electrical Code (CSA C22.1).
  - ATEX and IECEx Installations: The relevant requirements of EN 60079-14 and applicable National regulations.
- Do not attempt any repairs to this Banner device; it contains no field-replaceable parts or components. Tampering and/or replacement with non-factory components may adversely affect the safe use of the system.
- Approved Apparatus entity parameters must meet the following requirements:
  - $V_{oc}$  or  $V_t \leq V_{max}$
  - $C_a \geq C_i + C_{cable}$
  - $I_{sc}$  or  $I_t \leq I_{max}$
  - $L_a \geq L_j + L_{cable}$
- Sensor Entity Parameters:
  - $V_{max}(U_i) \leq 15$  V dc
  - $I_{max}(I_i) \leq 60$  mA
  - $P_i \leq 225$  mW
  - $C_i = 0.3$   $\mu$ F
  - $L_i = 0$  mH
- Cable Entity Parameters (if unknown):
  - $C_{cable} = 60$  pF/ft
  - $L_{cable} = 0.2$   $\mu$ H/ft
- The ambient operating temperature range of the Sensors is  $-40$  °C to  $+70$  °C ( $-40$  °F to  $+158$  °F).
- For U.S. installations, Class II and III, Division 2 applies only to model numbers ending in a Q suffix.
- For intrinsically safe installations, sensors must be used with certified intrinsically safe switching amplifiers and barriers (Approved Apparatus) with intrinsically safe circuits that limit supply voltage and current in the event of failures.
- Associated Apparatus is not required for installation of the devices within a Division 2 hazardous (classified) location when installed per the National Electrical Code. The maximum voltage for Division 2 installation is 15 V dc. In Division 2 installations (without Associated Apparatus), observe Explosion Hazard warning at the beginning of this section.
- Associated Apparatus is not required for installation of the devices within a Division 2 hazardous (classified) location when installed in, or through the wall of a suitable enclosure with provision for connection of rigid metal conduit per the Canadian Electrical Code, as acceptable to the local inspection authority having jurisdiction. The maximum rating for Division 2 installation is 15 V dc, 60 mA. In Division 2 installations (without Associated Apparatus), observe Explosion Hazard warning at the beginning of this section.
- Maximum non-hazardous area voltage that the Approved Apparatus (intrinsically safe circuit) is connected to must not exceed 250 V.
- Intrinsic safety ground, if required for the Associated Apparatus, shall be less than 1 ohm.
- Maximum connector torque: 6 ft-lbs.

## Wiring Connections

MIAD9 Series NUMAR sensors are intrinsically safe ONLY when used with certified intrinsically safe switching amplifiers and barriers (Approved Apparatus) with intrinsically safe circuits. Banner does not manufacture such devices; however, our applications engineers can refer you to suppliers of certified devices that will interface with Banner sensors.

The user is responsible for proper installation and maintenance of this equipment, and must conform with the certification requirements relating to barriers and to maximum allowable capacitance and inductance of the field wiring. If in doubt about these requirements, our applications engineers can refer you to the appropriate authority.

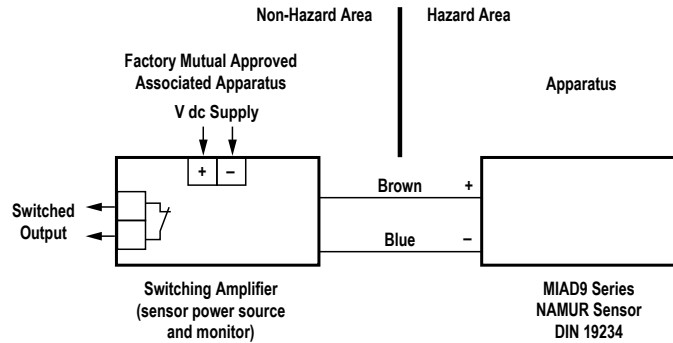

## Specifications

### Supply Voltage and Current

5 to 15 V dc (provided by the amplifier to which the sensor is connected)

### Adjustments

15-turn slotted brass screw GAIN (sensitivity) adjustment potentiometer (clutched at both ends of travel); located on rear panel and protected by a clear gasketed acrylic cover

### Indicators

Red LED Alignment Indicator Device (AID) located on rear panel lights when the sensor sees a "light" condition; pulse rate is proportional to signal strength (the stronger the signal, the faster the pulse rate).

### Construction

Reinforced thermoplastic polyester housing, totally encapsulated, o-ring sealing, acrylic lenses, and stainless steel screws

### Application Note

Special Conditions for Safe Use: Parts of the enclosure are non-conducting and may generate an ignition-capable level of ESD. Cleaning of the equipment must be done only with a damp cloth.

### Output

Constant current output:  $\leq 1.2$  mA in the "dark" condition and  $\geq 2.1$  mA in the "light" condition

### Output Response Time

Opposed mode: 2 ms ON/400  $\mu$ s OFF  
All other modes: 5 ms ON/OFF (does not include amplifier response)

### Environmental Rating

Banner tested to NEMA standards 1, 2, 3, 3S, 4, 4X, 6, 12 and 13  
IEC IEC IP67

### Operating Conditions

Temperature:  $-40$  °C to  $+70$  °C ( $-40$  °F to  $+158$  °F)

### Connections

PVC-jacketed 2-conductor 2 m or 9 m cables, or special 4-pin Euro-style quick-disconnect (QD) fitting are available; QD cables are ordered separately.

### Certifications



IEC IECEx FMG 14.0029X  
ATEX FM12ATEX0094X  
FM CoC 0003046293 (US)  
FM CoC 0003046293C (CAN)

Design Standards	
ATEX (European)	EN 60079-0, EN 60079-11 and EN 60079-26
Canada	CAN/CSA C22.2: No.0-M91, No.142-M1987, No.157-92, No.213-M1987, No.1010.1, E60079-0 and E60079-11
United States	FM Class 3600, 3610, and 3810; ANSI/ISA 61010-1 (82.02.01), 60079-0 and 60079-11
IECEX	IEC 60079-0, IEC 60079-11

Approvals	
MIAD9(a)(b), MI9E(b)	a = Sensing mode D, W, F, LV, LVAG, CV, CV2 or R. b = Connection method Q or blank.
ATEX (European)	II 1 G Ex ia IIC T5 Ta = -40°C to 70°C - 39616; Entity Entity Parameters: U <sub>i</sub> = 15 V dc, I <sub>i</sub> = 60 mA, P <sub>i</sub> = 225 mW, C <sub>i</sub> = 0.3 µF, L <sub>i</sub> = 0 mH.
Canadian	IS / I,II,III / 1 / ABCDEFG / T5 Ta = -40°C to 70°C - 39616; Entity I / 0 / Ex ia / IIC / T5 Ta = -40°C to 70°C - 39616; Entity (Non-incendive) NI / 1 / 2 / ABCD / T5 Ta = -40°C to 70°C Entity Parameters: V <sub>Max</sub> = 15 V dc, I <sub>Max</sub> = 60 mA, P <sub>i</sub> = 225 mW, C <sub>i</sub> = 0.3 µF, L <sub>i</sub> = 0 mH
United States	IS / I,II,III / 1 / ABCDEFG / T5 Ta = 70°C - 39616; Entity I / 0 / AEx ia / IIC / T5 Ta = -40°C to 70°C - 39616; Entity (Non-incendive) NI / 1 / 2 / ABCD / T5 Ta = -40°C to 70°C S / II,III / 2 / FG* / T5 Ta = -40°C to 70°C *Class II and III, Division 2 applies only to model numbers ending in a Q suffix. Entity Parameters: V <sub>Max</sub> = 15 V dc, I <sub>Max</sub> = 60 mA, P <sub>i</sub> = 225 mW, C <sub>i</sub> = 0.3 µF, L <sub>i</sub> = 0 mH
IECEX	Ex ia IIC T5 Ta = -40 °C to +70 °C - 35331; Entity Entity Parameters: U <sub>i</sub> = 15 V dc, I <sub>i</sub> = 60 mA, C <sub>i</sub> = 0.3 µF, L <sub>i</sub> = 0 mH.

# 130848D



FM12ATEX0094X



Ex ia IIC T5 Ga  
Ta = -40 °C to +70 °C

IECEX FMG 14.0029X Ex ia IIC T5



INSTALL PER DWG 39616

## Performance Curves

Model	Excess Gain	Beam Pattern
	Diffuse mode performance based on 90% reflectance white test card	
MI9E Emitter		
MIAD9R Receiver		

Model	Excess Gain	Beam Pattern
	Diffuse mode performance based on 90% reflectance white test card	
MIAD9LVAG		
MIAD9LV		
MIAD9D		
MIAD9W		

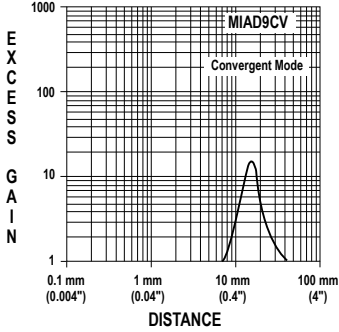
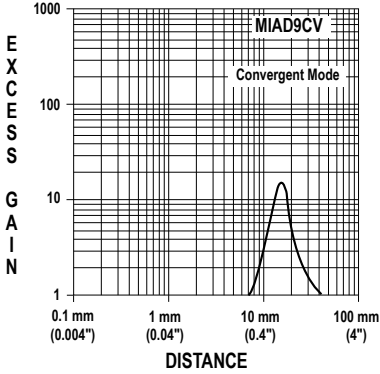
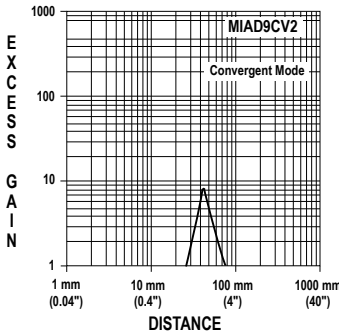
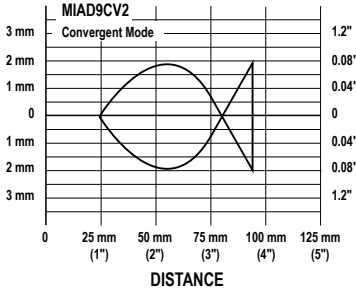
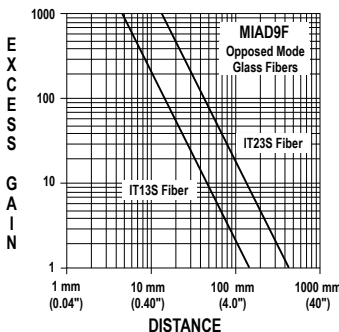
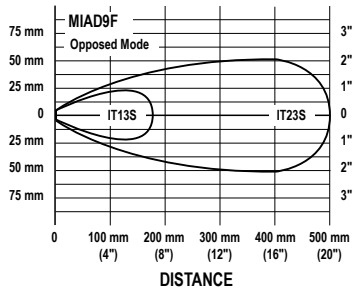
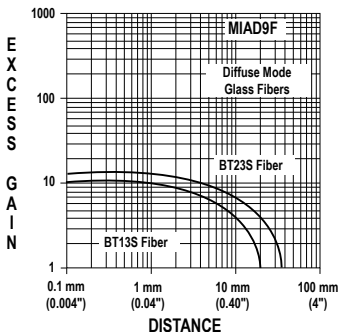
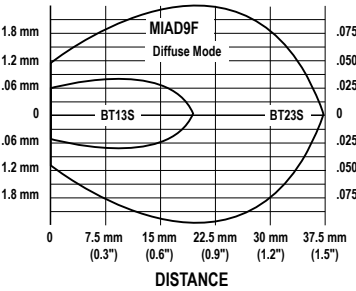
Model	Excess Gain	Beam Pattern
<b>Diffuse mode performance based on 90% reflectance white test card</b>		
MIAD9CV	 <p>Graph showing Excess Gain (log scale, 1 to 1000) vs. Distance (log scale, 0.1 mm to 100 mm). The curve for MIAD9CV shows a peak labeled 'Convergent Mode' at approximately 10 mm (0.4").</p>	 <p>Graph showing Excess Gain (log scale, 1 to 1000) vs. Distance (log scale, 0.1 mm to 100 mm). The curve for MIAD9CV shows a peak labeled 'Convergent Mode' at approximately 10 mm (0.4").</p>
MIAD9CV2	 <p>Graph showing Excess Gain (log scale, 1 to 1000) vs. Distance (log scale, 1 mm to 1000 mm). The curve for MIAD9CV2 shows a peak labeled 'Convergent Mode' at approximately 100 mm (4").</p>	 <p>Graph showing Excess Gain (log scale, 1 to 1000) vs. Distance (log scale, 1 mm to 1000 mm). The curve for MIAD9CV2 shows a peak labeled 'Convergent Mode' at approximately 100 mm (4").</p>
MIAD9F—Opposed Mode	 <p>Graph showing Excess Gain (log scale, 1 to 1000) vs. Distance (log scale, 1 mm to 1000 mm). The curve for MIAD9F Opposed Mode shows two lines: IT13S Fiber and IT23S Fiber. IT13S Fiber has a higher gain at shorter distances, while IT23S Fiber has a higher gain at longer distances.</p>	 <p>Graph showing Excess Gain (log scale, 1 to 1000) vs. Distance (log scale, 1 mm to 1000 mm). The curve for MIAD9F Opposed Mode shows two lines: IT13S Fiber and IT23S Fiber. IT13S Fiber has a higher gain at shorter distances, while IT23S Fiber has a higher gain at longer distances.</p>
MIAD9F—Diffuse Mode	 <p>Graph showing Excess Gain (log scale, 1 to 1000) vs. Distance (log scale, 0.1 mm to 100 mm). The curve for MIAD9F Diffuse Mode shows two lines: BT13S Fiber and BT23S Fiber. BT13S Fiber has a higher gain at shorter distances, while BT23S Fiber has a higher gain at longer distances.</p>	 <p>Graph showing Excess Gain (log scale, 1 to 1000) vs. Distance (log scale, 0.1 mm to 100 mm). The curve for MIAD9F Diffuse Mode shows two lines: BT13S Fiber and BT23S Fiber. BT13S Fiber has a higher gain at shorter distances, while BT23S Fiber has a higher gain at longer distances.</p>

## Dimensions

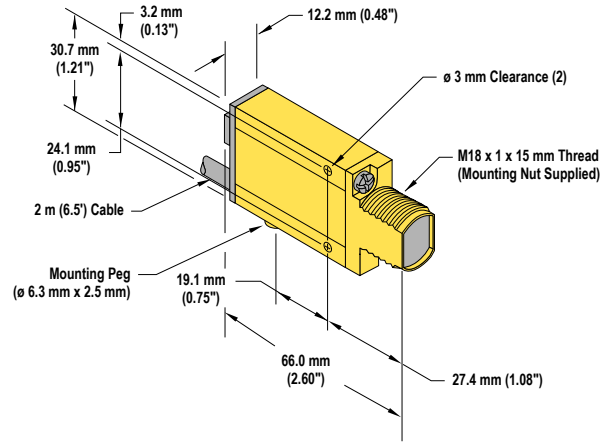

Figure 2. Opposed, Retro, Diffuse, Convergent Models (Suffix E, R, LV, D, and CV)

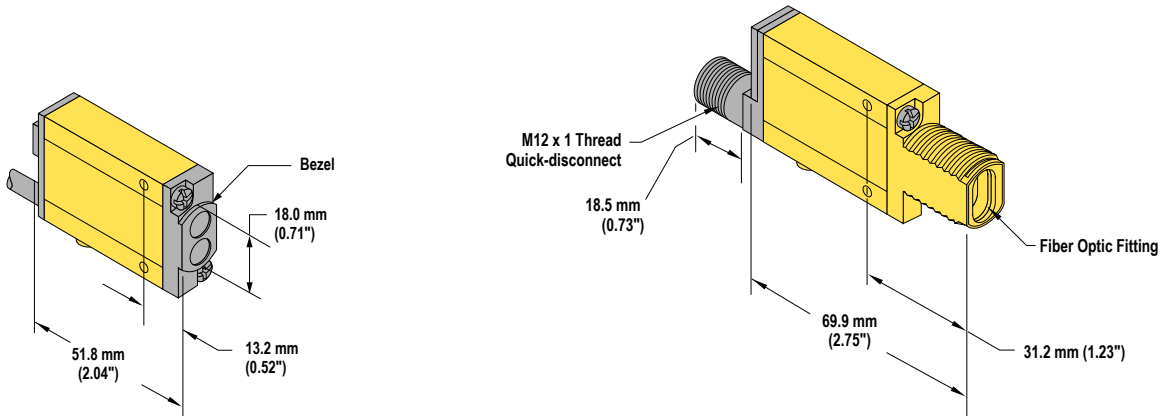

Figure 3. Diffuse Models (suffix W)

Figure 4. Glass Fiber Models (suffix F)

## Accessories

### Quick-Disconnect (QD) Cables

4-Pin Threaded M12/Euro-Style Cordsets (for use with NAMUR sensors)				
Model	Length	Style	Dimensions	Pinout (Female)
MQD9-406	1.83 m (6 ft)	Straight		<p>1 = Brown 2 = Blue</p>
MQD9-415	4.57 m (15 ft)			
MQD9-430	9.14 m (30 ft)			

4-Pin Threaded M12/Euro-Style Cordsets (for use with NAMUR sensors)				
Model	Length	Style	Dimensions	Pinout (Female)
MQD9-406RA	1.83 m (6 ft)	Right-Angle		
MQD9-415RA	4.57 m (15 ft)			
MQD9-430RA	9.14 m (30 ft)			

Brackets

**SMB312S**

- Stainless steel 2-axis, side-mount bracket

A = 4.3 × 7.5, B = diam. 3, C = 3 × 15.3

**SMB46U**

- Right-angle
- U bracket for sensor protection
- 14-ga. 316 stainless steel

Hole center spacing: A = 16.0  
Hole size: A = 16.5 × 18.7, B = 34.0 × 13.0

**SMB312B**

- Stainless steel 2-axis, bottom-mount bracket
- Includes mounting foot

A = diam. 6.9, B = 4.3 × 10.5, C = 3.1 × 15.2

**SMB18A**

- Right-angle mounting bracket with a curved slot for versatile orientation
- 12-ga. stainless steel
- 18 mm sensor mounting hole
- Clearance for M4 (#8) hardware

Hole center spacing: A to B = 24.2  
Hole size: A = ø 4.6, B = 17.0 × 4.6, C = ø 18.5

**SMB312PD**

- Right-angle mounting bracket with a curved slot for versatile orientation
- 12-ga. stainless steel
- 18 mm sensor mounting hole
- Clearance for M4 (#8) hardware

Hole center spacing: A to B = 24.2  
Hole size: A = ø 4.6, B = 17 × 4.6, C = ø 18.5

Note: Not for use with plastic fiber optic sensors

**SMB18FA..**

- Swivel bracket with tilt and pan movement for precision adjustment
- Easy sensor mounting to extruded rail T-slots
- Metric and inch size bolts available
- 18 mm sensor mounting hole

Hole size: B=ø 18.1

Model	Bolt Thread (A)
SMB18FA	3/8 - 16 × 2 in
SMB18FAM10	M10 - 1.5 × 50
SMB18FAM12	n/a; no bolt included. Mounts directly to 12 mm (½ in) rods



SMB46L

- Right-angle
- L bracket
- 14-ga. 316 stainless steel

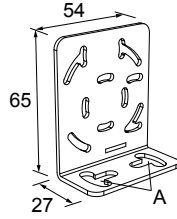

Hole center spacing: A = 16.0  
Hole size: A = 16.5 × 18.7

SMB18Q

- Right-angle flanged bracket
- 18 mm sensor mounting hole
- 12-ga. stainless steel

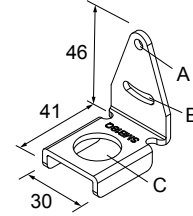

Hole center spacing: A to B = 24.2  
Hole size: A = ø 4.6, B = 17.0 × 4.6, C = ø 19.0

SMB46S

- Right-angle
- S bracket
- 14-ga. 316 stainless steel

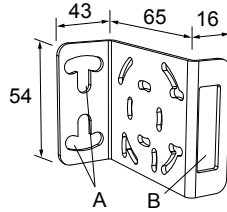

Hole center spacing: A = 16.0  
Hole size: A = 16.5 × 18.7, B = 34.0 × 10.0

SMB18SF

- 18 mm swivel bracket with M18 × 1 internal thread
- Black thermoplastic polyester
- Stainless steel swivel locking hardware included

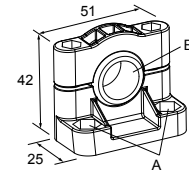

Hole center spacing: A = 36.0  
Hole size: A = ø 5.3, B = ø 18.0

SMB3018SC

- 18 mm swivel side or barrel-mount bracket
- Black reinforced thermoplastic polyester
- Stainless steel swivel locking hardware included

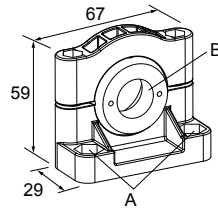

Hole center spacing: A = 50.8  
Hole size: A = ø 7.0, B = ø 18.0

SMB18UR

- 2-piece universal swivel bracket
- 300 series stainless steel
- Stainless steel swivel locking hardware included
- Mounting hole for 18 mm sensor

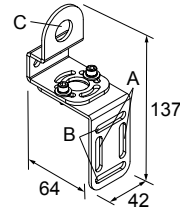

Hole center spacing: A = 25.4, B = 46.7  
Hole size: B = 6.9 × 32.0, C = ø 18.3

SMB30SUS

- Side-mount swivel with extended range of motion
- Black reinforced thermoplastic polyester
- Stainless steel swivel locking hardware included

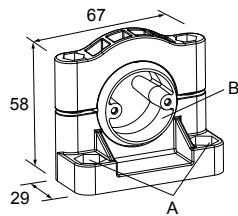

Hole center spacing: A = 50.8, B = 24.1  
Hole size: A = ø 7, B = ø 7.6

SMBAMS18P

- Flat SMBAMS series bracket with 18 mm hole
- Articulation slots for 90+° rotation
- 12-ga. (2.6 mm) cold-rolled steel

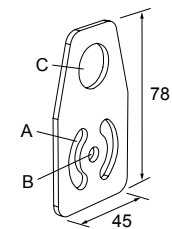

Hole center spacing: A = 26.0, A to B = 13.0  
Hole size: A = 26.8 × 7.0, B = ø 6.5, C = ø 19.0

**SMB30SK**

- Flat-mount swivel bracket with extended range of motion
- Black reinforced thermoplastic polyester and 316 stainless steel
- Stainless steel swivel locking hardware included

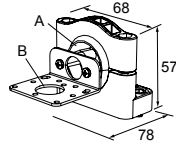

Hole center spacing: A = 50.8

Hole size: A =  $\varnothing 7$ , B =  $\varnothing 18$

**SMBAMS18RA**

- Right-angle SMBAMS series bracket with 18 mm hole
- Articulation slots for 90+° rotation
- 12-ga. (2.6 mm) cold-rolled steel

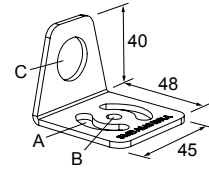

Hole center spacing: A = 26.0, A to B = 13.0

Hole size: A = 26.8 × 7.0, B =  $\varnothing 6.5$ , C =  $\varnothing 19.0$

## Repairs and Translations

Obtain assistance with product repairs by contacting your local Banner Engineering Corp distributor or by calling Banner directly at (763) 544-3164. Access literature translated into your native language on the Banner website at [www.bannerengineering.com](http://www.bannerengineering.com) or contact Banner directly at (763) 544-3164.

Para reparaciones de productos, por favor contacte a su distribuidor local de Banner Engineering o llame a Banner directamente al (763) 544-3164. Vea la literatura traducida en su idioma en el sitio web Banner en [www.bannerengineering.com](http://www.bannerengineering.com) o comuníquese con Banner directamente al (763) 544-3164.

Pour vous aider lors de la réparation de produits, contactez votre distributeur Banner local ou appelez directement Banner au (763) 544-3164. La documentation traduite dans votre langue est disponible sur le site internet de Banner [www.bannerengineering.com](http://www.bannerengineering.com) ou contactez directement Banner au (763) 544-3164.

## Banner Engineering Corp. Limited Warranty

Banner Engineering Corp. warrants its products to be free from defects in material and workmanship for one year following the date of shipment. Banner Engineering Corp. will repair or replace, free of charge, any product of its manufacture which, at the time it is returned to the factory, is found to have been defective during the warranty period. This warranty does not cover damage or liability for misuse, abuse, or the improper application or installation of the Banner product.

THIS LIMITED WARRANTY IS EXCLUSIVE AND IN LIEU OF ALL OTHER WARRANTIES WHETHER EXPRESS OR IMPLIED (INCLUDING, WITHOUT LIMITATION, ANY WARRANTY OF MERCHANTABILITY OR FITNESS FOR A PARTICULAR PURPOSE), AND WHETHER ARISING UNDER COURSE OF PERFORMANCE, COURSE OF DEALING OR TRADE USAGE.

This Warranty is exclusive and limited to repair or, at the discretion of Banner Engineering Corp., replacement. IN NO EVENT SHALL BANNER ENGINEERING CORP. BE LIABLE TO BUYER OR ANY OTHER PERSON OR ENTITY FOR ANY EXTRA COSTS, EXPENSES, LOSSES, LOSS OF PROFITS, OR ANY INCIDENTAL, CONSEQUENTIAL OR SPECIAL DAMAGES RESULTING FROM ANY PRODUCT DEFECT OR FROM THE USE OR INABILITY TO USE THE PRODUCT, WHETHER ARISING IN CONTRACT OR WARRANTY, STATUTE, TORT, STRICT LIABILITY, NEGLIGENCE, OR OTHERWISE.

Banner Engineering Corp. reserves the right to change, modify or improve the design of the product without assuming any obligations or liabilities relating to any product previously manufactured by Banner Engineering Corp. Any misuse, abuse, or improper application or installation of this product or use of the product for personal protection applications when the product is identified as not intended for such purposes will void the product warranty. Any modifications to this product without prior express approval by Banner Engineering Corp will void the product warranties. All specifications published in this document are subject to change. Banner reserves the right to modify product specifications or update documentation at any time. Specifications and product information in English supersede that which is provided in any other language. For the most recent version of any documentation, refer to:

[www.bannerengineering.com](http://www.bannerengineering.com).