

Xtra Long Life SPDT Switch

50Ω DC to 18 GHz 12 Volt

MSP2T-18-12+



CASE STYLE: FK811

Connectors	Model
SMA	MSP2T-18-12+

+RoHS Compliant

The +Suffix identifies RoHS Compliance. See our web site for RoHS Compliance methodologies and qualifications

Maximum Ratings

Operating Temperature	-15°C to +45°C
Storage Temperature	-15°C to +85°C
RF Power (any single port)	10W
Control Voltage	13VDC

Permanent damage may occur if any of these limits are exceeded.

Features

- low voltage operation, 12V
- low insertion loss, 0.25 dB typ.
- high isolation, 80 dB typ.
- high power handling, 10W
- ultra reliable
- break-before-make configuration
- reflective failsafe switch
- protected by US Patents 5,272,458; 6,414,577; 6,650,210; 7,633,361; 7,843,289

Applications

- Automatic Test Equipment (ATE)
- reliable "sleeptime" switching
- redundancy switching for microwave radio

Outline Drawing

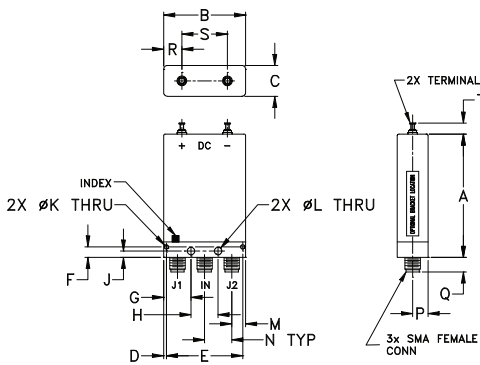

Outline Dimensions (inch/mm)

A	B	C	D	E	F	G	H	J	K
2.00	1.34	.50	.045	1.240	.170	.445	.440	.103	.070
50.80	34.04	12.70	1.14	31.50	4.32	11.30	11.18	2.62	1.78

L	M	N	P	Q	R	S	T	wt
.120	.230	.440	.25	.24	.297	.740	.19	grams
3.05	5.84	11.18	6.35	6.10	7.54	18.80	4.83	41.0

Marking Drawing

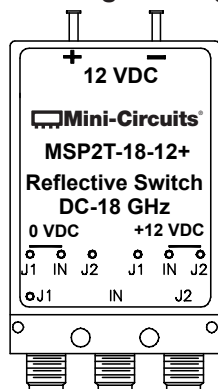

Electrical Specifications

Parameter	Condition (GHz)	Min.	Typ.	Max.	Unit
Frequency Range		DC	—	18	GHz
Insertion Loss	DC - 1	—	0.10	0.15	dB
	1 - 8	—	0.20	0.30	
	8 - 12	—	0.25	0.35	
	12 - 18	—	0.30	0.45	
Isolation	DC - 1	85	100	—	dB
	1 - 8	75	90	—	
	8 - 12	70	80	—	
	12 - 18	60	66	—	
VSWR	DC - 1	—	1.05	1.10	:1
	1 - 8	—	1.20	1.35	
	8 - 12	—	1.20	1.35	
	12 - 18	—	1.15	1.40	
DC Current @ +12V	DC - 18	—	180	230	mA
RF Power Cold Switching⁴	DC - 18	—	—	10	W
RF Power Hot Switching	Note 1	—	—	0.1	W
	Note 2	DC - 18	—	1.0	

Additional Specifications

Operating Voltage Range	12V (nom) ±0.5V
Switching Time (Typ.)	20ms
Life ³ (Min.)	1year/10 million switch cycles

Notes

1. To achieve specified life, hot switching RF power must not exceed this level.
2. Degradation in life (min.) to typically 3 million switch cycles for hot switch at this RF power level.
3. Tested at 0 dBm RF power.
4. Power handling is specified with RF applied to the IN port and output load connected to either J1 or J2.

Switching States

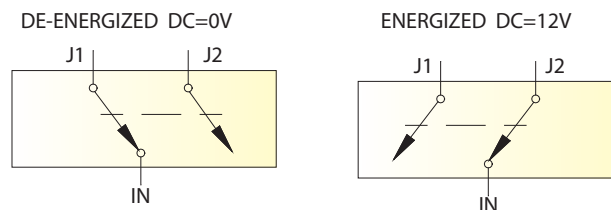

Notes

- A. Performance and quality attributes and conditions not expressly stated in this specification document are intended to be excluded and do not form a part of this specification document.
- B. Electrical specifications and performance data contained in this specification document are based on Mini-Circuit's applicable established test performance criteria and measurement instructions.
- C. The parts covered by this specification document are subject to Mini-Circuits standard limited warranty and terms and conditions (collectively, "Standard Terms"); Purchasers of this part are entitled to the rights and benefits contained therein. For a full statement of the Standard Terms and the exclusive rights and remedies thereunder, please visit Mini-Circuits' website at www.minicircuits.com/WCLStore/terms.jsp



Typical Performance Data

FREQ. (MHz)	ON INSERTION LOSS (dB)		OFF ISOLATION (dB)		VSWR, IN (:1)		VSWR (J1, J2) (:1)	
	IN-J1	IN-J2	IN-J1	IN-J2	De- Energized	Energized	(J1) De-	(J2)
							Energized	Energized
10.0	0.00	0.01	85.77	94.22	1.00	1.01	1.01	1.00
100.0	0.01	0.01	102.87	105.34	1.00	1.00	1.00	1.00
1000.0	0.04	0.04	115.37	105.64	1.01	1.01	1.01	1.01
2000.0	0.06	0.06	115.69	98.42	1.02	1.02	1.02	1.02
3000.0	0.07	0.07	107.32	105.01	1.06	1.06	1.06	1.06
4000.0	0.09	0.10	103.20	113.10	1.12	1.12	1.12	1.12
5000.0	0.12	0.12	104.85	109.83	1.18	1.18	1.18	1.18
6000.0	0.13	0.14	102.48	103.47	1.20	1.21	1.21	1.20
7000.0	0.14	0.14	112.75	105.01	1.18	1.19	1.19	1.18
8000.0	0.14	0.14	98.41	96.58	1.14	1.15	1.15	1.14
9000.0	0.13	0.14	96.65	96.81	1.10	1.11	1.11	1.10
10000.0	0.14	0.14	96.31	96.57	1.08	1.08	1.09	1.08
11000.0	0.15	0.16	92.76	93.91	1.09	1.10	1.10	1.10
12000.0	0.17	0.18	88.40	90.44	1.14	1.14	1.14	1.14
13000.0	0.18	0.20	87.03	89.57	1.17	1.18	1.18	1.17
14000.0	0.20	0.21	84.38	85.14	1.18	1.19	1.19	1.18
15000.0	0.20	0.22	82.56	83.98	1.16	1.18	1.18	1.16
16000.0	0.21	0.23	81.52	83.15	1.13	1.16	1.17	1.14
17000.0	0.22	0.24	78.85	80.32	1.13	1.16	1.16	1.15
18000.0	0.24	0.28	75.92	77.77	1.19	1.18	1.19	1.19

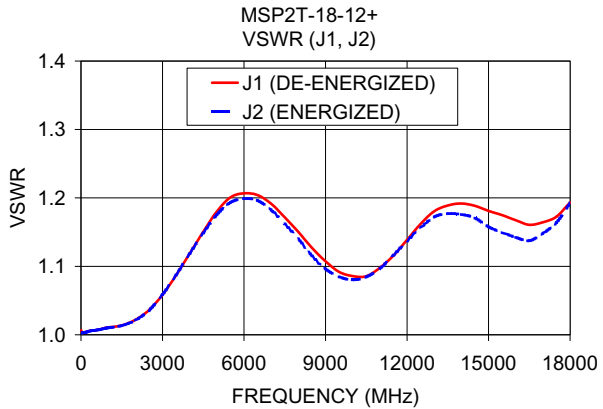
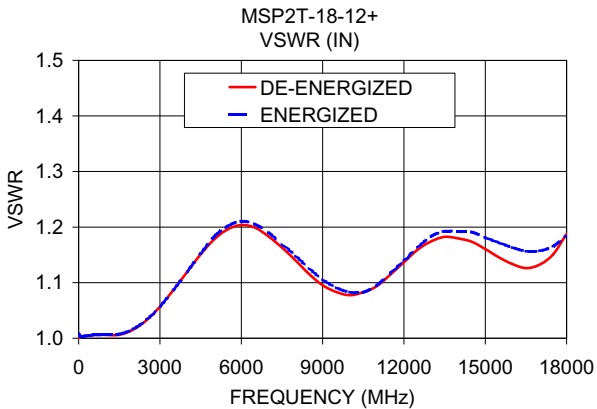
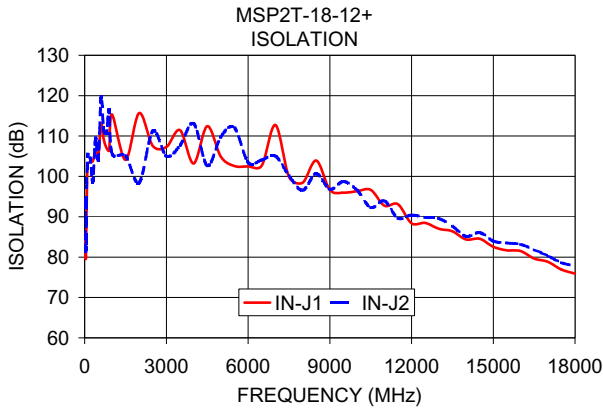
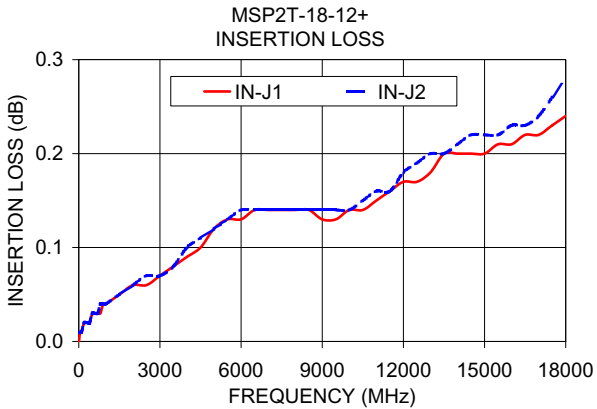

Notes
 A. Performance and quality attributes and conditions not expressly stated in this specification document are intended to be excluded and do not form a part of this specification document.
 B. Electrical specifications and performance data contained in this specification document are based on Mini-Circuit's applicable established test performance criteria and measurement instructions.
 C. The parts covered by this specification document are subject to Mini-Circuits standard limited warranty and terms and conditions (collectively, "Standard Terms"); Purchasers of this part are entitled to the rights and benefits contained therein. For a full statement of the Standard Terms and the exclusive rights and remedies thereunder, please visit Mini-Circuits' website at www.minicircuits.com/MCLStore/terms.jsp

