

Ultra High Dynamic Range

# Monolithic Amplifier

PHA-202+

50Ω 0.03 to 2.7 GHz

## The Big Deal

- Ultra High IP3, +46.1 dBm
- Broadband High Dynamic Range without external Matching Components
- Medium power, 1W
- Excellent return loss over 15 dB

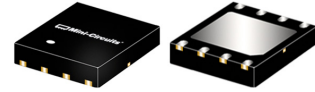

CASE STYLE: DL1636

## Product Overview

The PHA-202+ (RoHS compliant) is a medium power amplifier fabricated using E-PHEMT technology and offers extremely high dynamic range over a broad frequency range and with low noise figure. In addition, the PHA-202+ has good input and output return loss over a broad frequency range without the need for external matching components and has demonstrated excellent reliability. It has repeatable performance from lot to lot and is enclosed in a 5mm x 6mm, 8 lead package for very good thermal performance.

## Key Features

Feature	Advantages
Broad Band: 0.03 to 2.7 GHz	Broadband covering primary wireless communications bands: Cellular, PCS, LTE
Extremely High IP3 Versus DC power Consumption 46 dBm typical at 1.0 GHz	The PHA-202+ matches industry leading IP3 performance relative to device size and power consumption. The combination of the design and E-PHEMT Structure provides enhanced linearity over a broad frequency range as evidence in the IP3 being typically 14-23 dB above the P1dB point. This feature makes this amplifier ideal for use in: <ul style="list-style-type: none"><li>• Driver amplifiers for complex waveform up converter paths</li><li>• Drivers in linearized transmit systems</li><li>• Secondary amplifiers in ultra High Dynamic range receivers</li></ul>
No External Matching Components Required	Unlike competing products, Mini-Circuits PHA-202+ provides Input and Output Return Loss of over 15 dB up to 2 GHz without the need for any external matching components



Ultra High Dynamic Range

# Monolithic Amplifier

0.03-2.7 GHz

## Product Features

- High IP3, 46.1 dBm typ. at 1 GHz
- Gain, 17.0 dB typ. at 1 GHz
- High Pout, P1dB 30.4 dBm typ. at 1 GHz
- No external matching components required

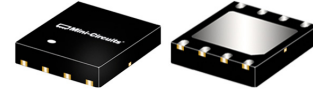

## PHA-202+

CASE STYLE: DL1636

## Typical Applications

- Base station infrastructure
- CATV
- LTE

### +RoHS Compliant

The +Suffix identifies RoHS Compliance. See our web site for RoHS Compliance methodologies and qualifications

## General Description

The PHA-202+ (RoHS compliant) is a medium power amplifier fabricated using E-PHEMT technology and offers extremely high dynamic range over a broad frequency range and with low noise figure. In addition, the PHA-202+ has good input and output return loss over a broad frequency range without the need for external matching components and has demonstrated excellent reliability. It has repeatable performance from lot to lot and is enclosed in a 5mm x 6mm, 8 lead package for very good thermal performance.

## simplified schematic and pin description

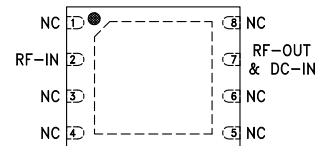
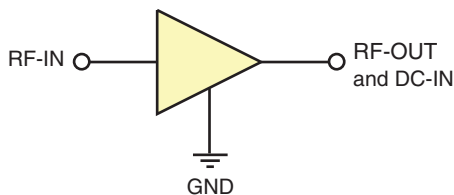

Function	Pin Number	Description
RF-IN	2	RF input
RF-OUT and DC-IN	7	RF output and DC input
GND	Paddle	Ground
NC	1,3-6,8	No connection

Electrical Specifications at 25°C, 50 ohms, unless noted

Parameter	Condition (MHz)	Vd=11V <sup>1</sup>			Vd=11V <sup>2</sup>	Units
		Min.	Typ.	Max.	Typ.	
Frequency range		0.03		2.7	0.03-2.7	GHz
Gain	30	—	18.3	—	18.3	dB
	500	—	17.9	—	17.7	
	1000	—	17.0	—	16.8	
	2000	13.2	14.7	16.1	14.3	
	2700	—	12.7	—	12.1	
Input return loss	30		21.2		20.5	dB
	500		21.7		25.5	
	1000		19.5		28.6	
	2000		20.3		17.7	
	2700		14.9		12.0	
Output return loss	30		15.1		15.5	dB
	500		16.4		15.2	
	1000		19.4		15.7	
	2000		22.5		19.1	
	2700		9.8		9.4	
Reverse isolation	2000		23		23.3	dB
Output power @ 1dB compression	30		28.4		29.2	dBm
	500		30.2		29.8	
	1000		30.4		29.8	
	2000		28.1		27.0	
	2700		25.7		25.2	
Output IP3 <sup>3</sup>	30		51.0		50.3	dBm
	500		48.5		48.8	
	1000		46.1		46.2	
	2000		43.2		41.7	
	2700		39.4		38.8	
Noise figure	30		3.2		3.0	dB
	500		3.3		3.0	
	1000		3.5		3.3	
	2000		4.4		4.3	
	2700		5.4		5.2	
Device operating voltage			11		11	V
Device operating current		—	350	416	335	mA
Device current variation vs. temperature <sup>4</sup>			188.6		188.6	μA/°C
Device current variation vs voltage <sup>5</sup>			0.0485		0.0485	mA/mV
Thermal Resistance, junction-to-ground lead at 85°C stage temp.			16.1		16.1	°C/W

1. Measured on Mini-Circuits Characterization test board MB018. See Characterization Test Circuit (Fig. 1)
2. Measured on Mini-Circuits Application test board TB-962+. See Characterization Test Circuit (Fig. 2)
3. Tested at Pout=16dBm / tone.
4. (Current at 85°C — Current at -45°C)/130
5. (Current at 11.5V-current - Current at 10.5V)/1000

Absolute Maximum Ratings<sup>6</sup>

Parameter	Ratings
Operating Temperature (ground lead)	-40°C to 85°C
Storage Temperature	-65°C to 150°C
Junction Temperature	179°C
Power Dissipation	5.8W
Input Power (CW)	+24 dBm (5 minutes max.) +19 dBm (continuous)
DC Voltage on Pin 7	14V

6. Permanent damage may occur if any of these limits are exceeded.  
Electrical maximum ratings are not intended for continuous normal operation.

Characterization Test Circuit

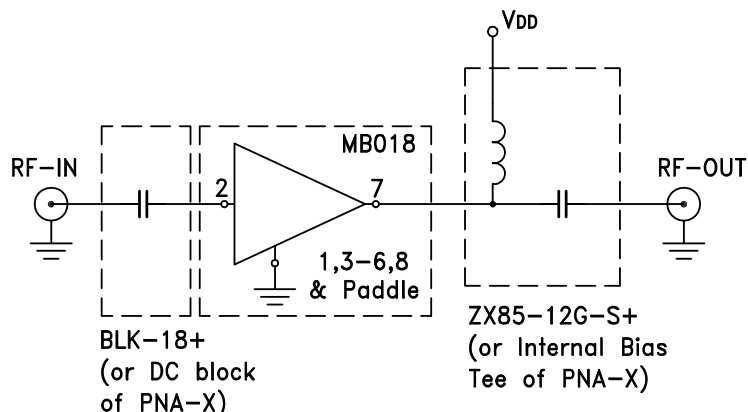

Fig 1. Characterization Circuit

Note: This block diagram is used for characterization. (DUT soldered on Mini-Circuits Characterization test board MB018) Gain, Return loss, Output power at 1dB compression (P1 dB), output IP3 (OIP3) and noise figure measured using Agilent's N5242A PNA-X microwave network analyzer.

Conditions:

1. Gain and Return loss: Pin= -25dBm
2. Output IP3 (OIP3): Two tones, spaced 1 MHz apart, 16 dBm/tone at output.

Recommended Application Circuit

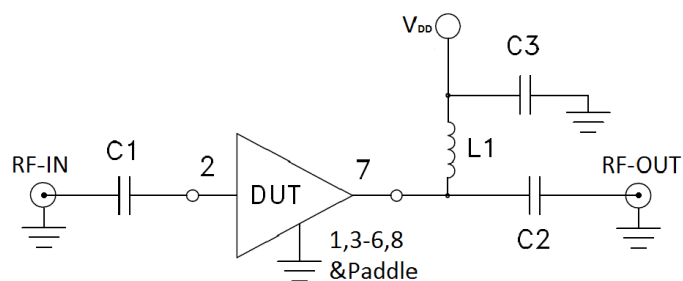

Component	P/N	SUPPLIER	Value	Size
C1, C2, C3	GRM155R71E103KA01D	MURATA	0.01uF	0402
L1	WA8514-AE	COILCRAFT	5.6uH	1708

Fig 2. Application Circuit

Note: (DUT soldered on Mini-Circuits Application test board TB-962+) Gain, Return loss, Output power at 1dB compression (P1 dB), output IP3 (OIP3) and noise figure measured using Agilent's N5242A PNA-X microwave network analyzer.

Conditions:

1. Gain and Return loss: Pin= -25dBm
2. Output IP3 (OIP3): Two tones, spaced 1 MHz apart, 16 dBm/tone at output.

Product Marking

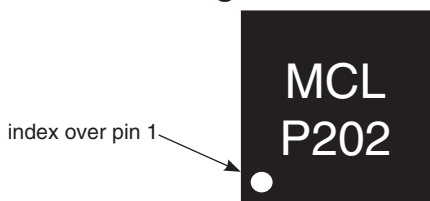

Marking may contain other features or characters for internal lot control

<b>Additional Detailed Technical Information</b> <i>additional information is available on our dash board. To access this information <a href="#">click here</a></i>	
<b>Performance Data</b>	Data Table
	Swept Graphs
	S-Parameter (S2P Files) Data Set (.zip file)
<b>Case Style</b>	DL1636 <i>Plastic package, exposed paddle lead finish: Matte Tin</i>
<b>Tape &amp; Reel</b> Standard quantities available on reel	F68 <i>7" reels with 20, 50, 100, 200, 500 or 1K devices 13" reels with 2K, 3K, 4K devices</i>
<b>Suggested Layout for PCB Design</b>	PL-522
<b>Evaluation Board</b>	TB-962+
<b>Environmental Ratings</b>	ENV08T1

### ESD Rating

Human Body Model (HBM): Class 1B (Pass 500V) in accordance with ANSI/ESD STM 5.1 - 2001

### MSL Rating

Moisture Sensitivity: MSL1 in accordance with IPC/JEDEC J-STD-020D

### MSL Test Flow Chart

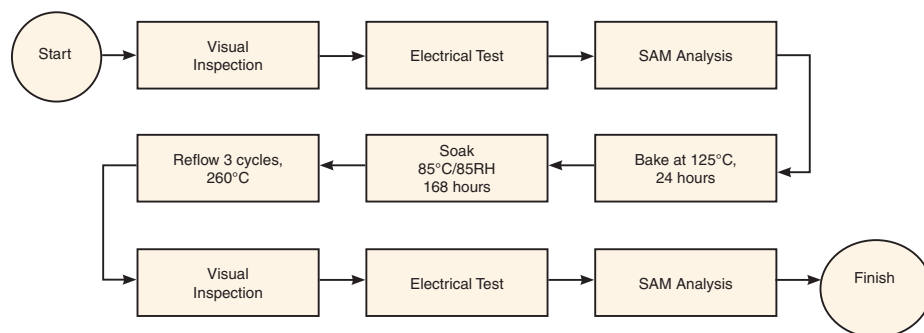

### Additional Notes

- A. Performance and quality attributes and conditions not expressly stated in this specification document are intended to be excluded and do not form a part of this specification document.
- B. Electrical specifications and performance data contained in this specification document are based on Mini-Circuit's applicable established test performance criteria and measurement instructions.
- C. The parts covered by this specification document are subject to Mini-Circuits standard limited warranty and terms and conditions (collectively, "Standard Terms"); Purchasers of this part are entitled to the rights and benefits contained therein. For a full statement of the Standard Terms and the exclusive rights and remedies thereunder, please visit Mini-Circuits' website at [www.minicircuits.com/MCLStore/terms.jsp](http://www.minicircuits.com/MCLStore/terms.jsp)