

Product Overview

Qorvo's QPA1009 is a laminate packaged wide band power amplifier MMIC fabricated on Qorvo's production 0.15 um GaN on SiC process (QGaN15). Covering 10.7 – 12.7 GHz, the QPA1009 provides greater than 16 Watts (42 dBm) of saturated output power and 16 dB of large-signal gain while achieving 33% power-added efficiency.

The QPA1009 RF ports have DC blocking capacitors and are matched to 50 ohms. The QPA1009 RF input port is DC coupled to ground for optimum ESD performance.

The QPA1009 is packaged in a 6.0 x 5.0 mm laminate package. The QPA1009 can support a wide range of operating conditions, including CW operation, making it well-suited for both commercial and military systems.

Lead-free and RoHS compliant.

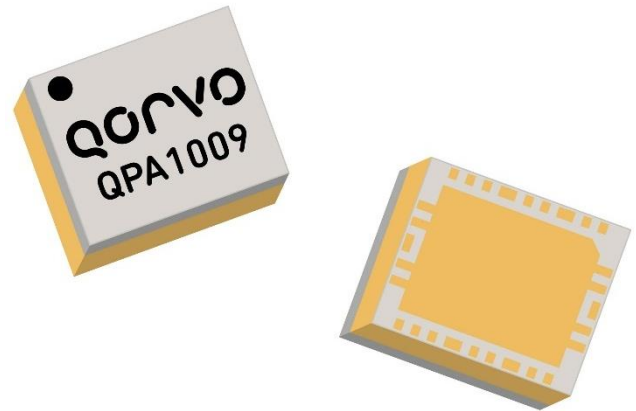

Key Features

- Frequency Range: 10.7 – 12.7 GHz
- P_{SAT} :43 dBm ($P_{IN} = 27$ dBm)
- PAE: 33% ($P_{IN} = 27$ dBm)
- Power Gain: 16 dB ($P_{IN} = 27$ dBm)
- Small Signal Gain: 21 dB
- Bias: $V_D = 20$ V, $I_{DQ} = 300$ mA
- Package Dimensions: 6.00 x 5.00 x 1.76 mm

Performance is typical across frequency. Please reference electrical specification table and data plots for more details.

Functional Block Diagram

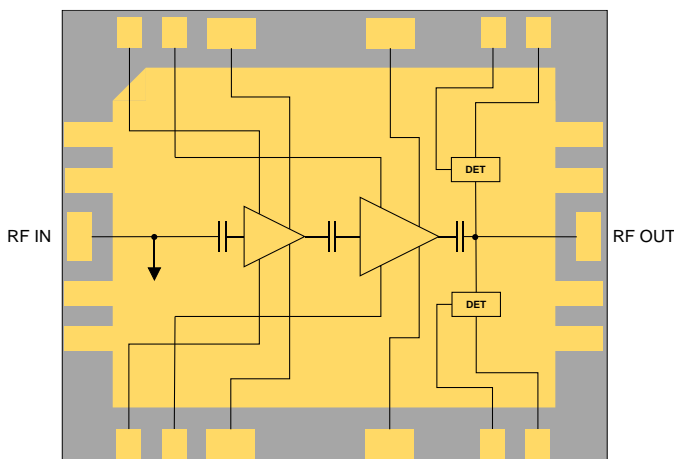

Top View

Applications

- Satellite Communications
- Radar
- Point to Point Communications

Ordering Information

Part No.	Description
QPA1009	10.7 – 12.7 GHz GaN Power Amplifier
QPA1009EVB	Evaluation Board for QPA1009
QPA1009TR7	QPA1009 on 250 piece reel

Absolute Maximum Ratings

Parameter	Value / Range
Drain Voltage (V_D)	29.5 V
Gate Voltage Range (V_G)	-4 V to 0 V
Drain Current (I_{D1}/I_{D2}) (T=85 °C)	0.42 / 4.0 A
Gate Current (I_G)	See plot page 11
P_{DISS} (under drive), 85 °C	59.5 W
Input Power, 50 Ω , $V_D=20$ V, $I_{DQ}=300$ mA, CW, 85 °C	31 dBm
Input Power, 3:1 VSWR, $V_D=20$ V, $I_{DQ}=300$ mA, CW, 85 °C	31 dBm
Soldering Temperature	260 °C
Storage Temperature	-55 to +125 °C

Operation of this device outside the parameter ranges given above may cause permanent damage. These are stress ratings only, and functional operation of the device at these conditions is not implied.

Recommended Operating Conditions

Parameter	Min	Typ	Max	Unit
Drain Voltage (V_D)		20		V
Drain Current (I_{DQ})		300	600	mA
Operating Temperature	-40	25	85	°C

Electrical specifications are measured at specified test conditions. Specifications are not guaranteed over all recommended operating conditions.

Electrical Specifications

Parameter		Min	Typ	Max	Units
Operational Frequency		10.7		12.7	GHz
Output Power (P _{IN} =27 dBm)	10.7 GHz		43.3		dBm
	11.7 GHz		43.2		dBm
	12.7 GHz		43.0		dBm
PAE (P _{IN} =27 dBm)	10.7 GHz		37.5		%
	11.7 GHz		33.3		%
	12.7 GHz		35.3		%
Small Signal Gain	10.7 GHz		21.4		dB
	11.7 GHz		21.9		dB
	12.7 GHz		21.6		dB
Input Return Loss	10.7 GHz		18		dB
	11.7 GHz		15		dB
	12.7 GHz		15		dB
Output Return Loss	10.7 GHz		5		dB
	11.7 GHz		6		dB
	12.7 GHz		10		dB
2 ND Harmonic Level (P _{IN} =27 dBm)	10.7 GHz		-31		dBc
	11.7 GHz		-36		dBc
	12.7 GHz		-39		dBc
Third Order IM Distortion (P _{OUT} /Tone = 34 dBm, 50 MHz tone spacing)	10.7 GHz		-24		dBc
	11.7 GHz		-32		dBc
	12.7 GHz		-32		dBc
P _{OUT} Temp. Coeff. (85 °C to -40 °C, P _{IN} = 27 dBm)			-0.009		dB/°C
Sm. Sig. Gain Temp. Coefficient (85 °C to -40 °C)			-0.068		dB/°C
Gate Leakage Current (V _D = +10 V, V _G = -3.7 V)		-13.2			mA

Test conditions, unless otherwise noted: T = 25 °C, V_D = 20 V, I_{DQ} = 300 mA

Performance Plots – Large Signal

Test conditions, unless otherwise noted: $V_D = 20\text{ V}$, $I_{DQ} = 300\text{ mA}$, $T = +25\text{ }^\circ\text{C}$, $P_{IN} = 27\text{ dBm}$, CW

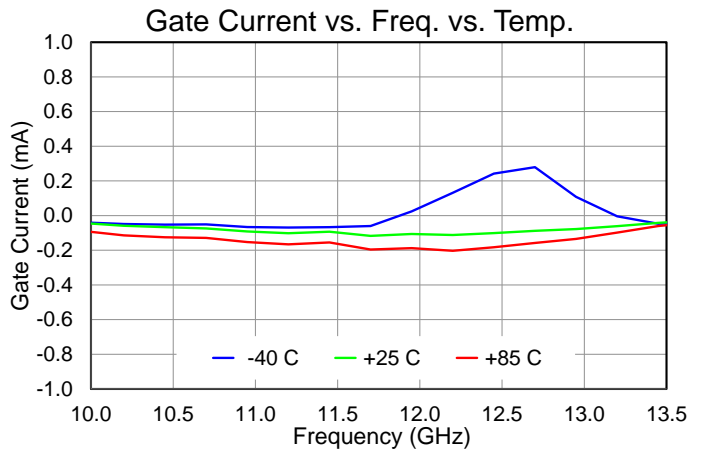
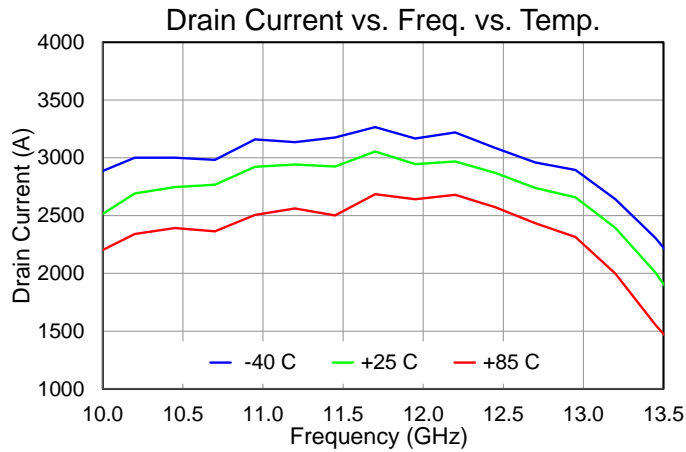
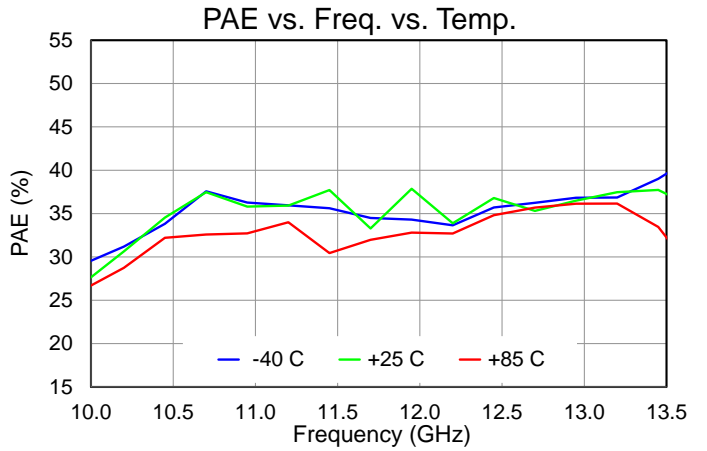
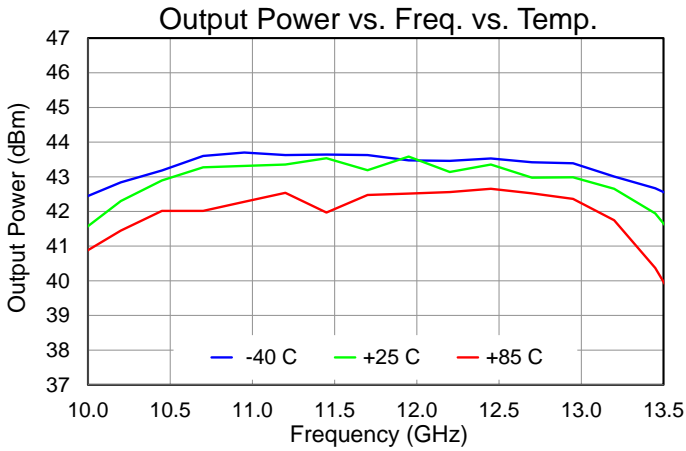

Performance Plots – Large Signal

Test conditions, unless otherwise noted: $V_D = 20\text{ V}$, $I_{DQ} = 300\text{ mA}$, $T = +25\text{ }^\circ\text{C}$, $P_{IN} = 27\text{ dBm}$, CW

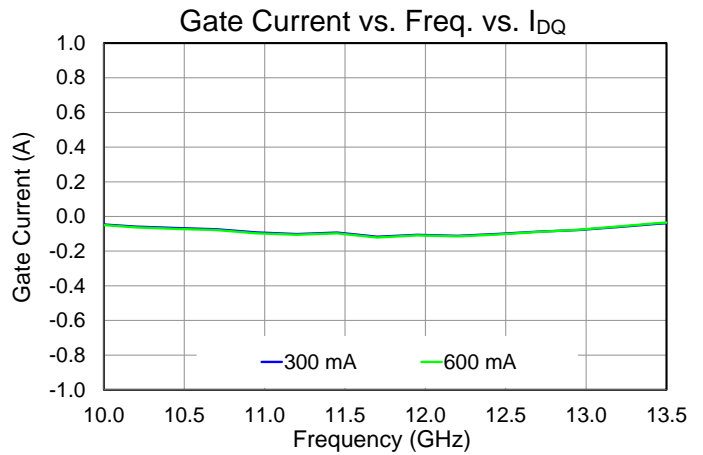
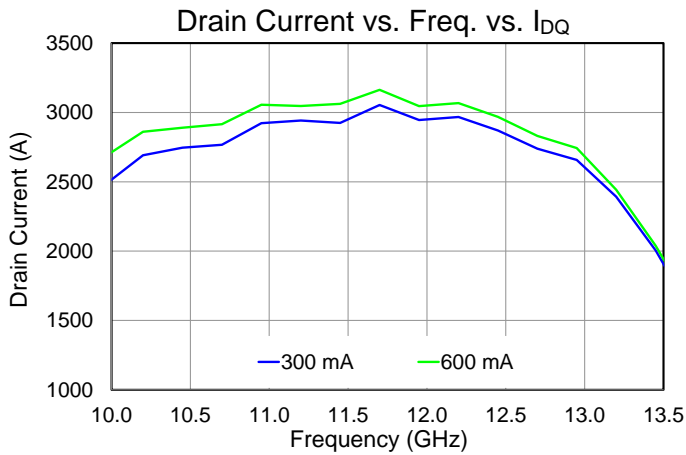
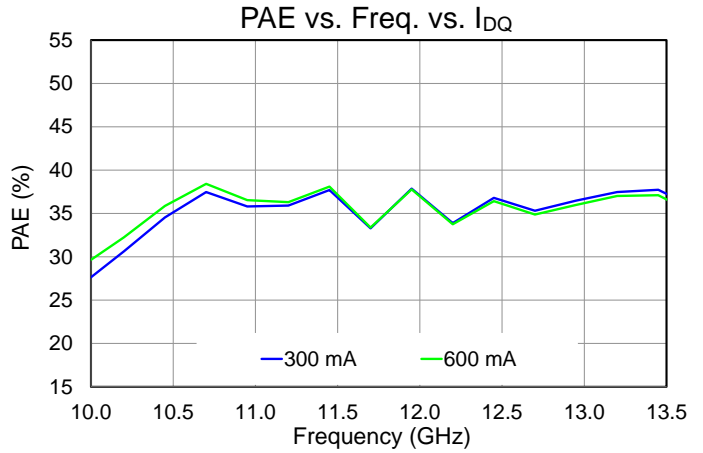
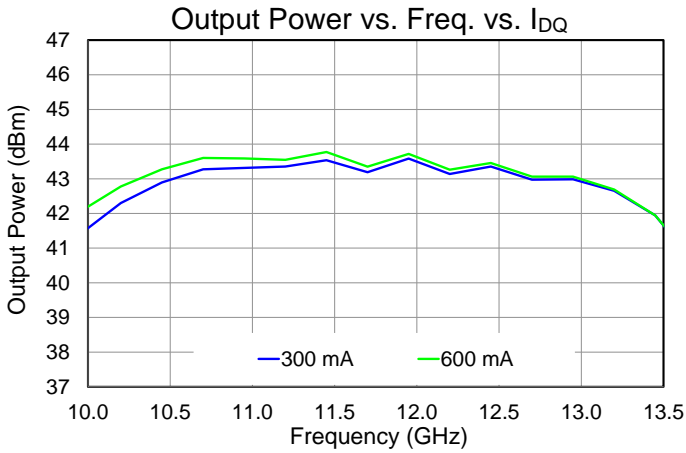

Performance Plots – Large Signal

Test conditions, unless otherwise noted: $V_D = 20\text{ V}$, $I_{DQ} = 300\text{ mA}$, $T = +25\text{ }^\circ\text{C}$, CW

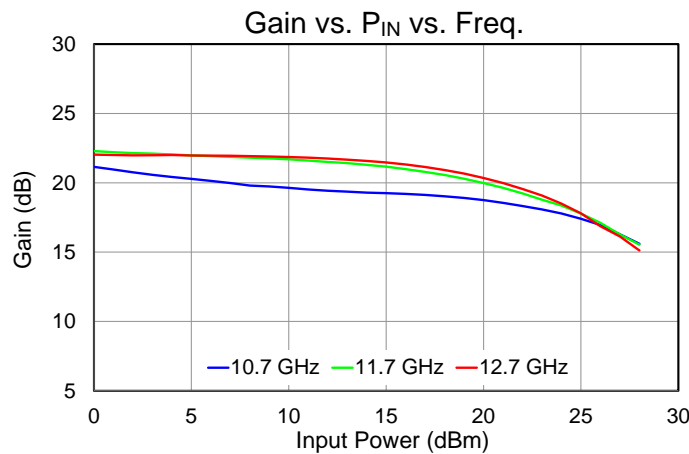
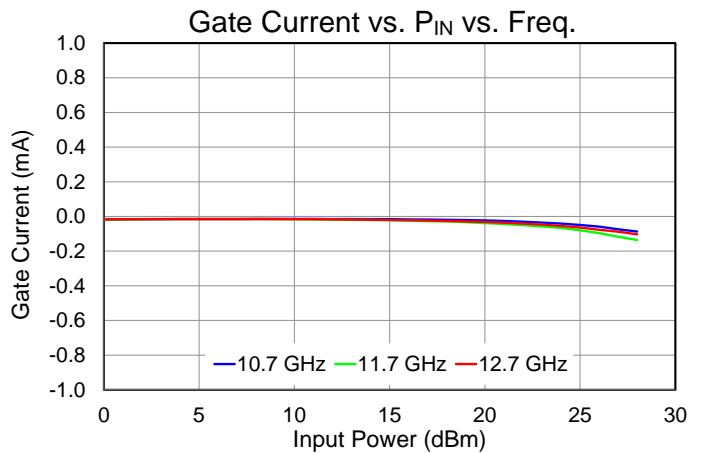
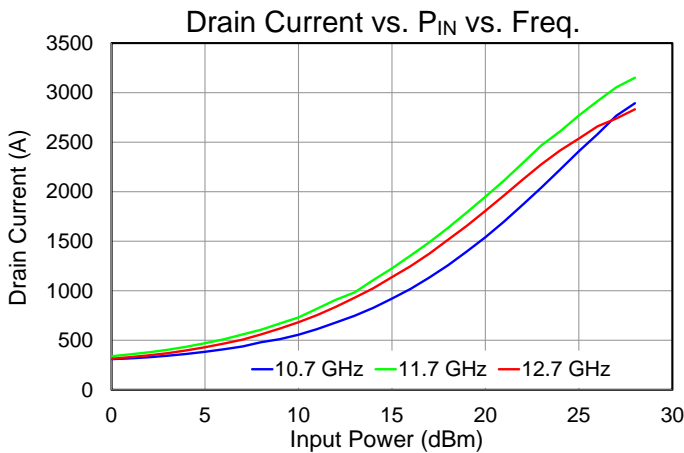
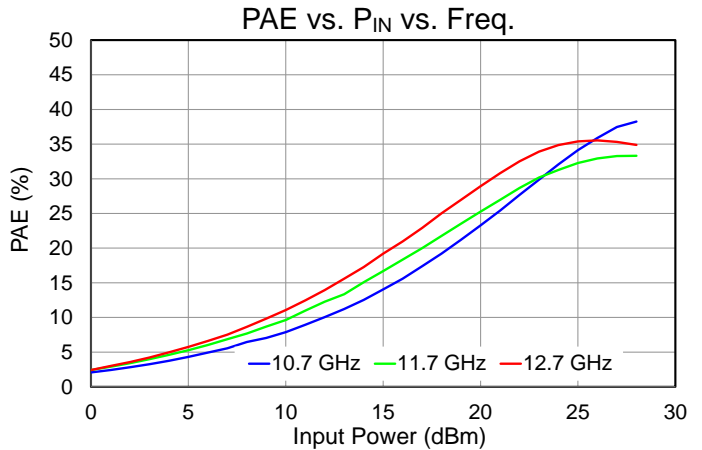
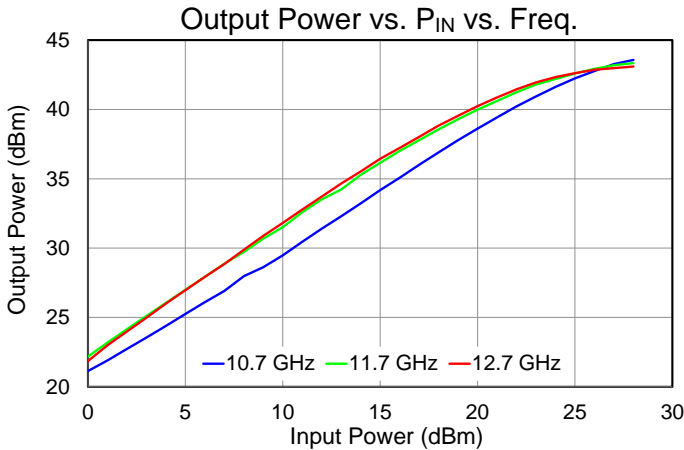

Performance Plots – Large Signal

Test conditions, unless otherwise noted: $V_D = 20\text{ V}$, $I_{DQ} = 300\text{ mA}$, $T = +25\text{ }^\circ\text{C}$, Freq. = 11.7 GHz, CW

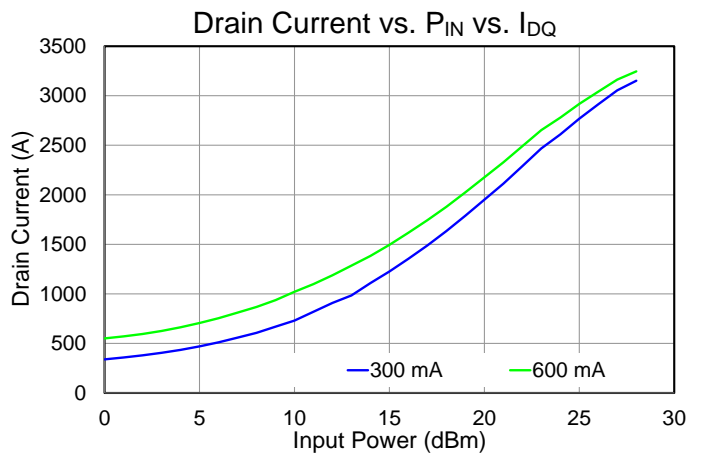
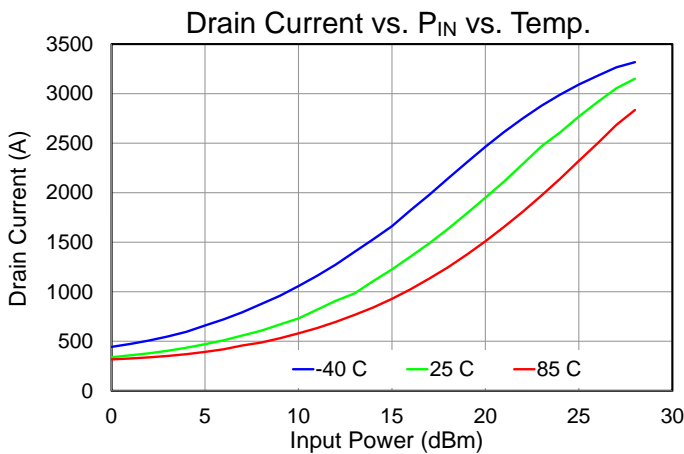
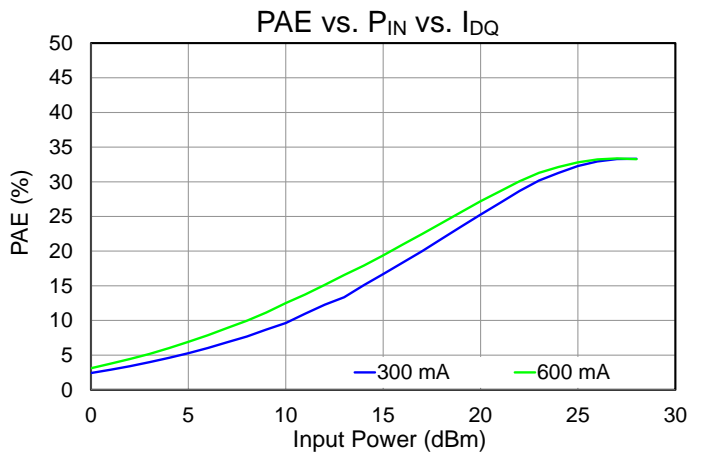
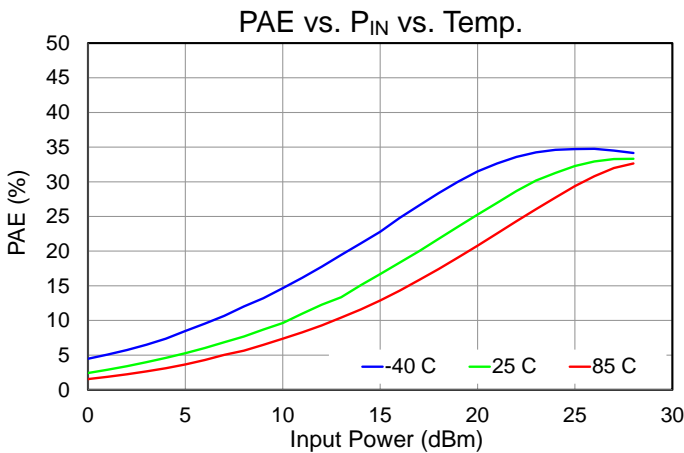
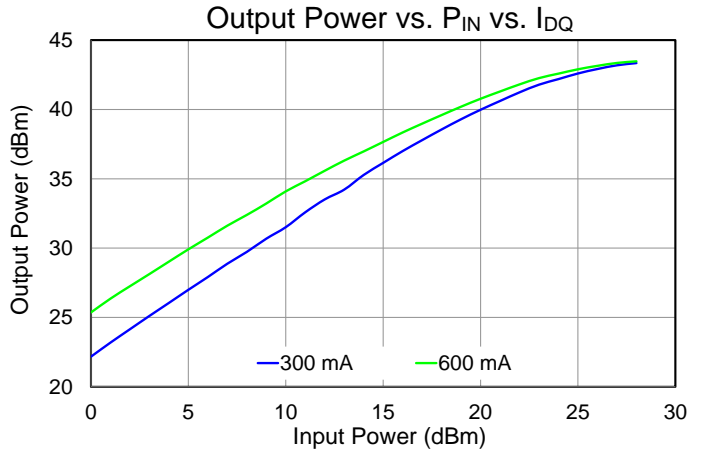
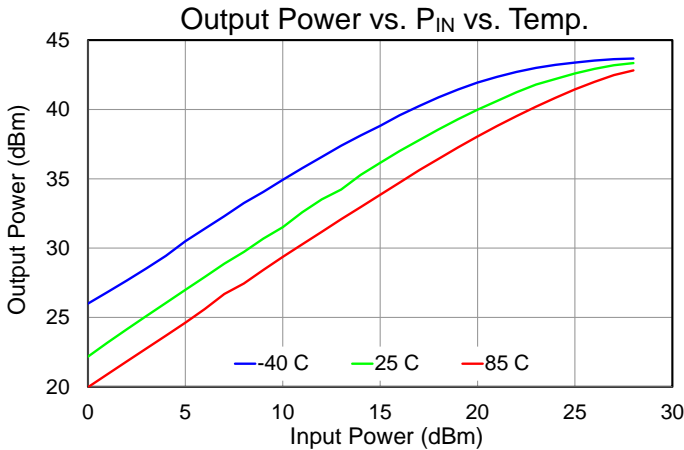

Performance Plots – Small Signal

Test conditions, unless otherwise noted: $V_D = 20\text{ V}$, $I_{DQ} = 300\text{ mA}$, $T = +25\text{ }^\circ\text{C}$, CW

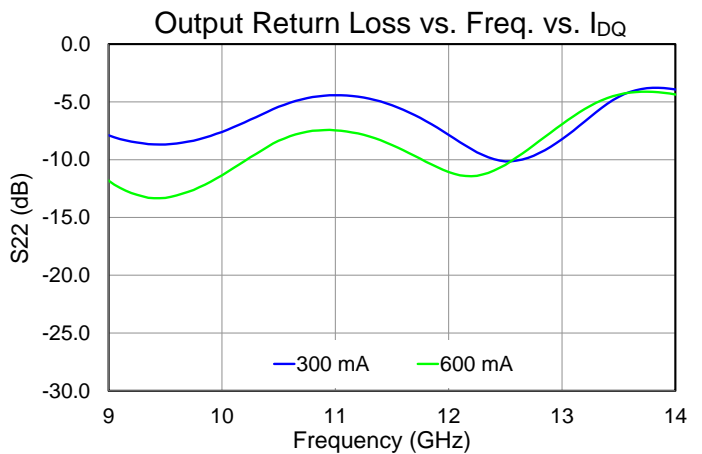
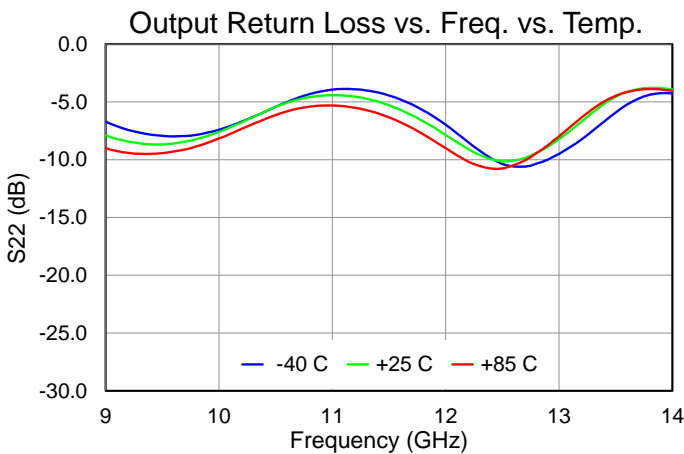
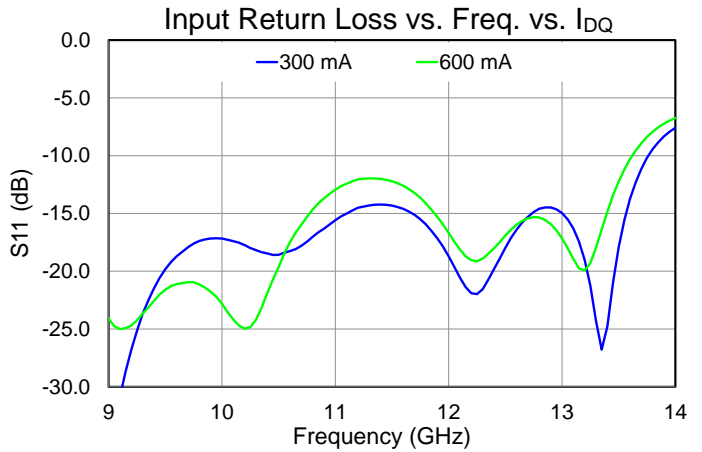
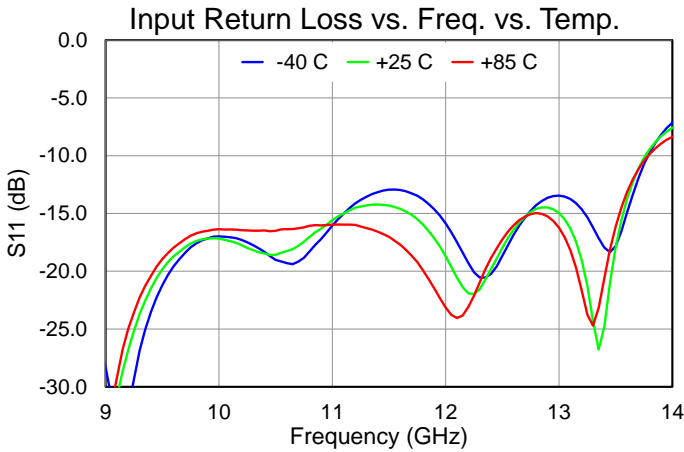
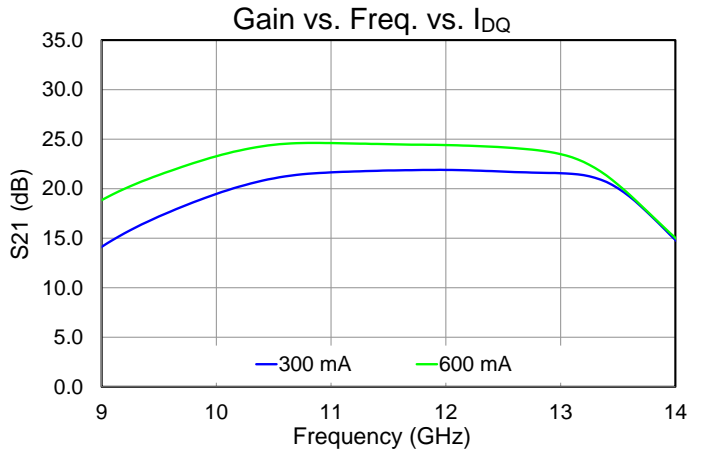
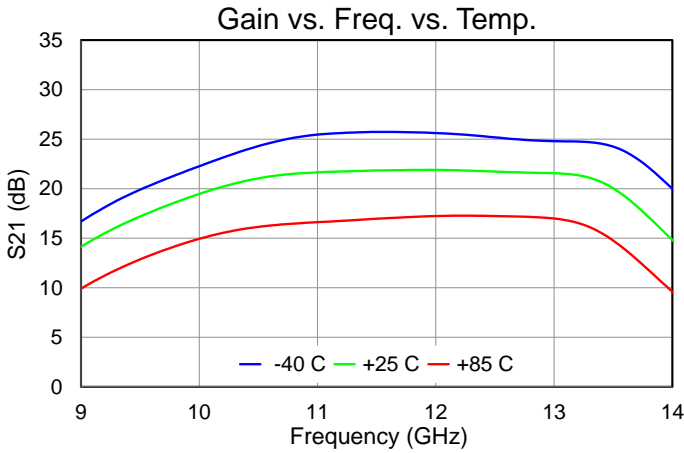

Performance Plots – Linearity

Test conditions, unless otherwise noted: $V_D = 20\text{ V}$, $I_{DQ} = 300\text{ mA}$, $T = +25\text{ }^\circ\text{C}$, CW, $F_c = 11.7\text{ GHz}$, Tone Spacing = 50 MHz

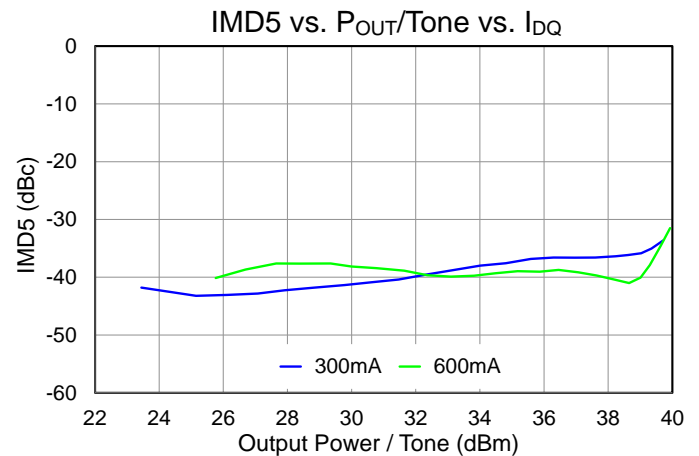
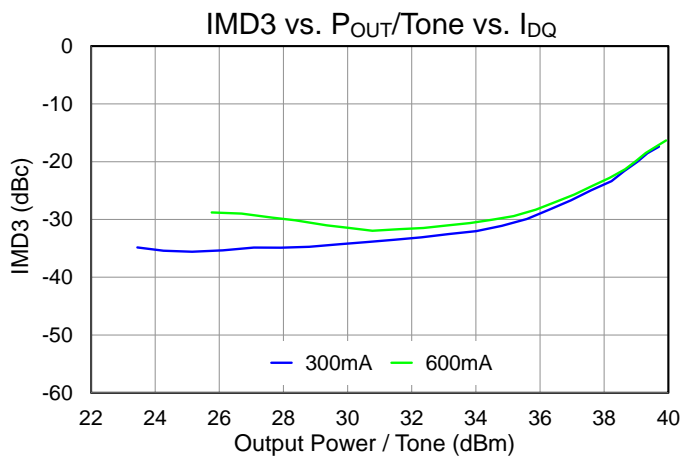
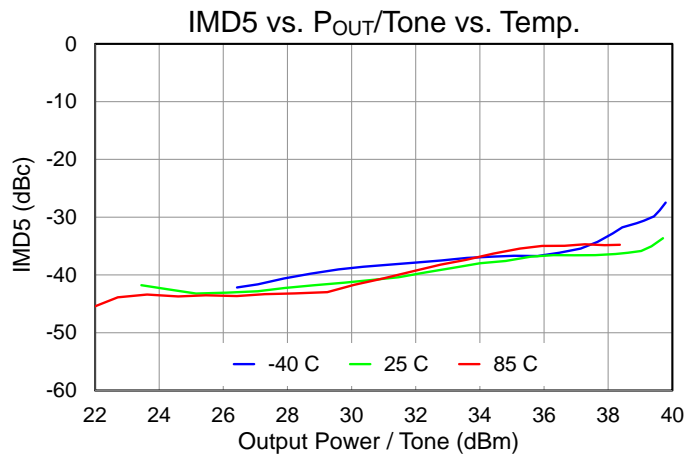
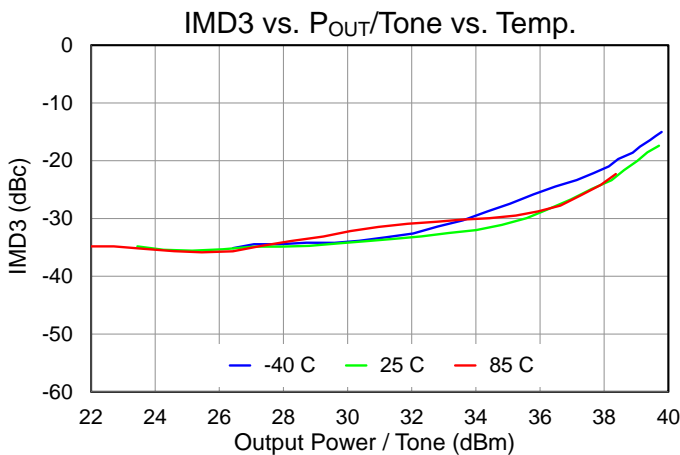
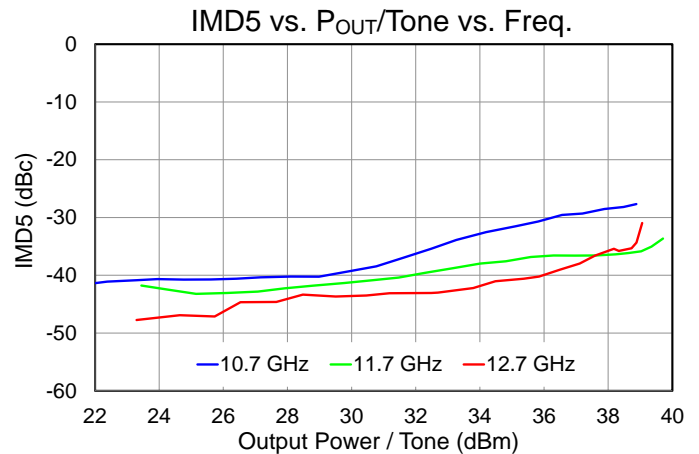
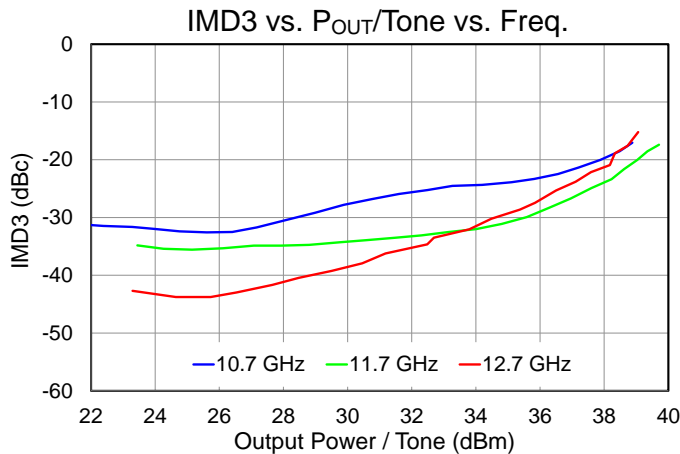

Performance Plots – Linearity, Harmonics

Test conditions, unless otherwise noted: $V_D = 20\text{ V}$, $I_{DQ} = 300\text{ mA}$, $T = +25\text{ }^\circ\text{C}$, CW, $F_C = 11.7\text{ GHz}$, Tone Spacing = 50 MHz

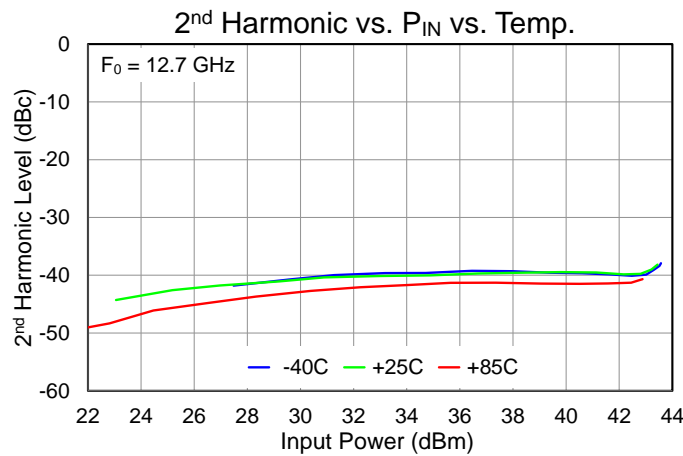
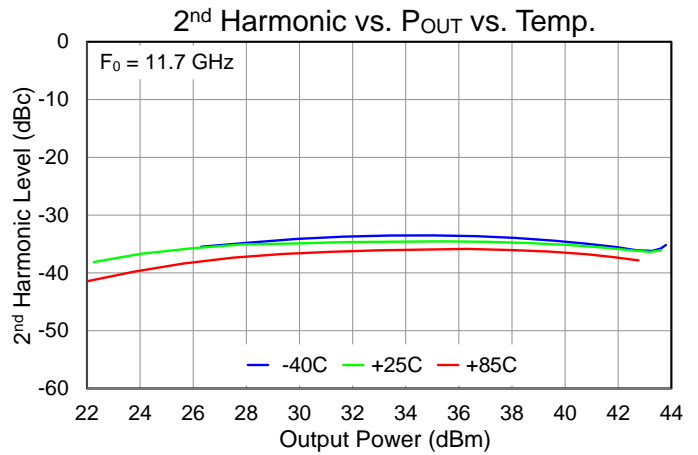
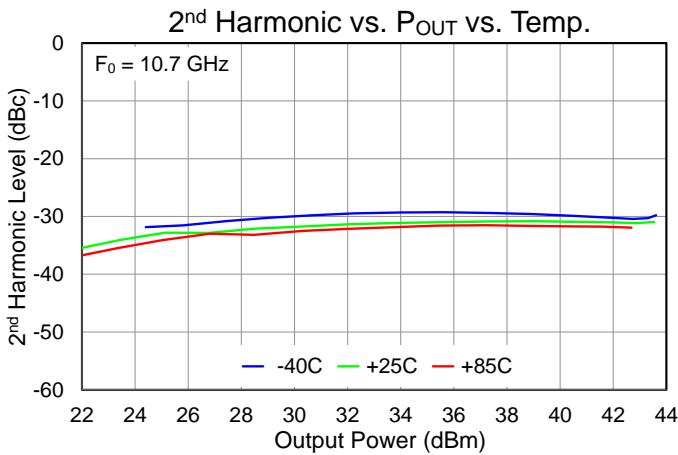
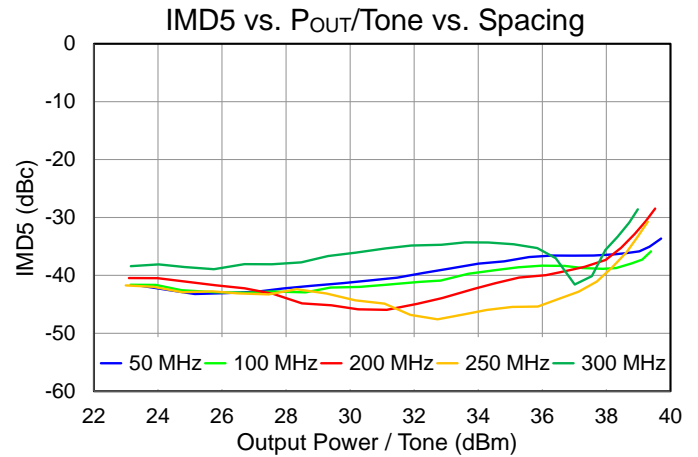
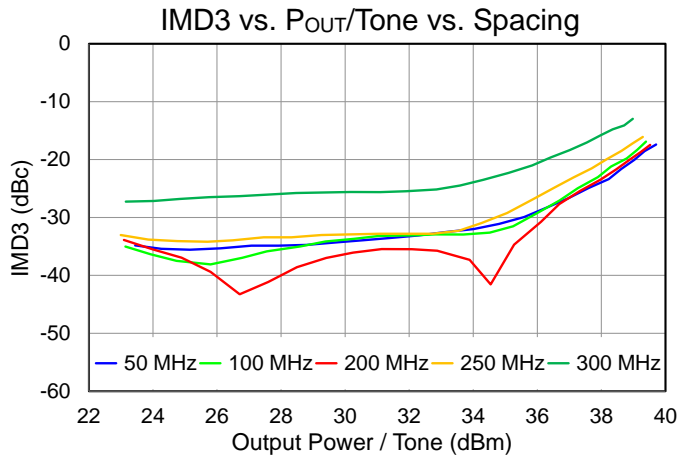

Thermal and Reliability Information

Parameter	Test Conditions	Value	Units
Thermal Resistance (θ_{JC}) ⁽¹⁾	$T_{base} = 85\text{ }^{\circ}\text{C}$, $V_D = 20\text{ V}$, $I_{DQ} = 300\text{ mA}$, $P_{DISS} = 6.0\text{ W}$ (Quiescent; no RF drive)	0.818	$^{\circ}\text{C}/\text{W}$
Channel Temperature, T_{CH} (Quiescent) ⁽²⁾		89.9	$^{\circ}\text{C}$
Thermal Resistance (θ_{JC}) ⁽¹⁾	$T_{base} = 85\text{ }^{\circ}\text{C}$, $V_D = 20\text{ V}$, $I_{DQ} = 300\text{ mA}$, $Freq = 11.7\text{ GHz}$, $I_{D_Drive} = 2684\text{ mA}$, $P_{IN} = 27\text{ dBm}$, $P_{OUT} = 42.5\text{ dBm}$, $P_{DISS} = 36.1\text{ W}$	1.270	$^{\circ}\text{C}/\text{W}$
Channel Temperature, T_{CH} (w/ RF drive) ⁽²⁾		130.8	$^{\circ}\text{C}$

Notes:

- Thermal resistance determined to the back of package, T_{base} (85 $^{\circ}\text{C}$)
- T_{CH} values are IR Scan equivalent temperatures. Refer to the following document: [GaN Device Channel Temperature, Thermal Resistance, and Reliability Estimates](#)

Dissipated Power and Maximum Gate Current

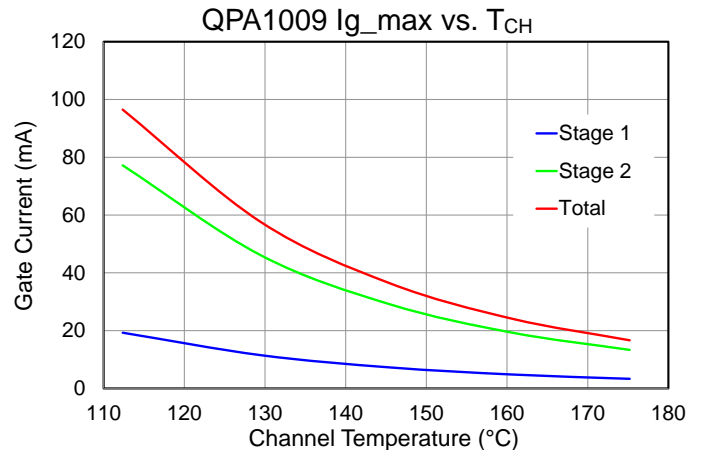
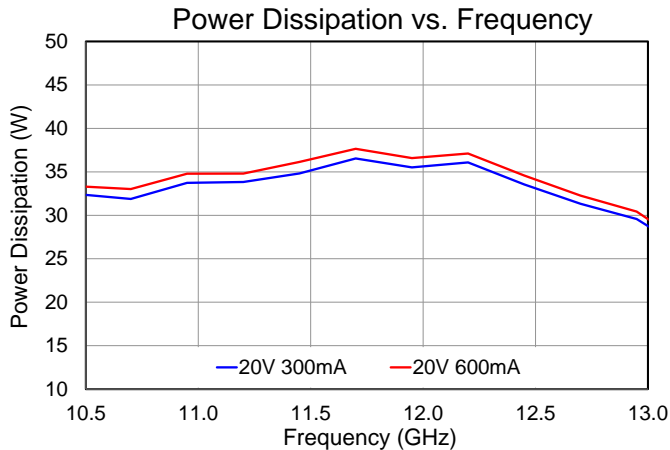

Test conditions, unless otherwise noted: $V_D = 20\text{ V}$, $I_{DQ} = 300\text{ mA}$, $T = +25\text{ }^{\circ}\text{C}$, $P_{IN} = 27\text{ dBm}$

Applications Information

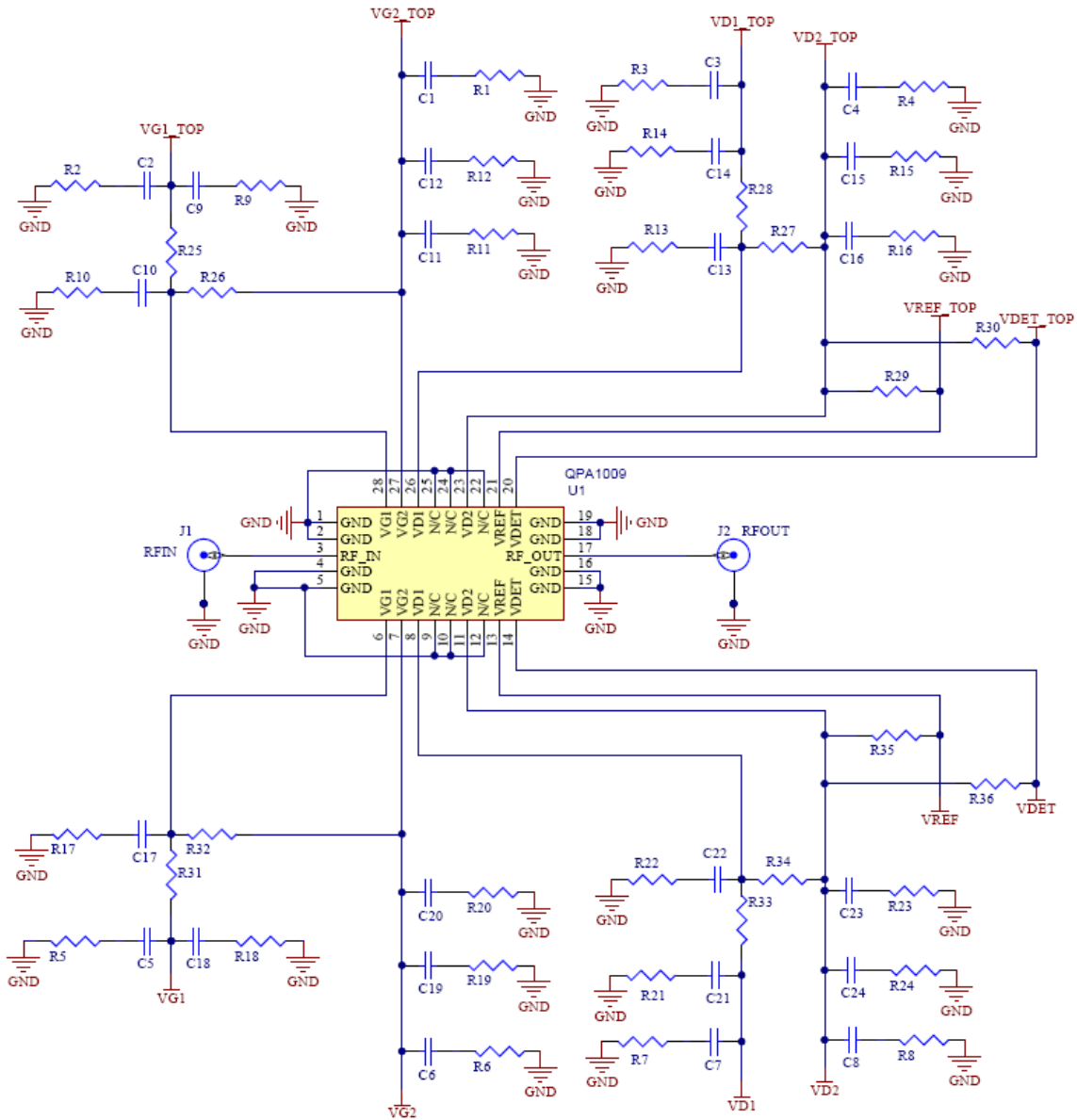

Bias-Up Procedure

- Turn on V_G supply and set $V_G = -4V$, I_G limit to 20 mA
- Turn on V_D supply and set $V_D = 0V$, I_D limit to 3750 mA
- Adjust V_D to 20 V
- Adjust V_G to obtain desired I_{DQ} (300 mA)

Bias-Down Procedure

- Set $V_G = -4 V$
- Set $V_D = 0 V$
- Turn off V_D Supply
- Turn off V_G Supply

Evaluation Board (EVB) Layout Assembly

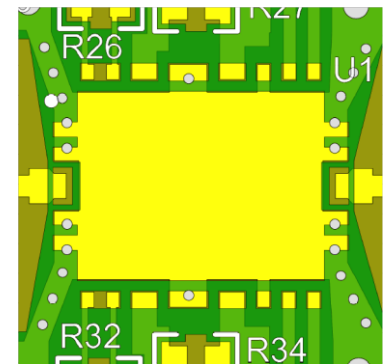
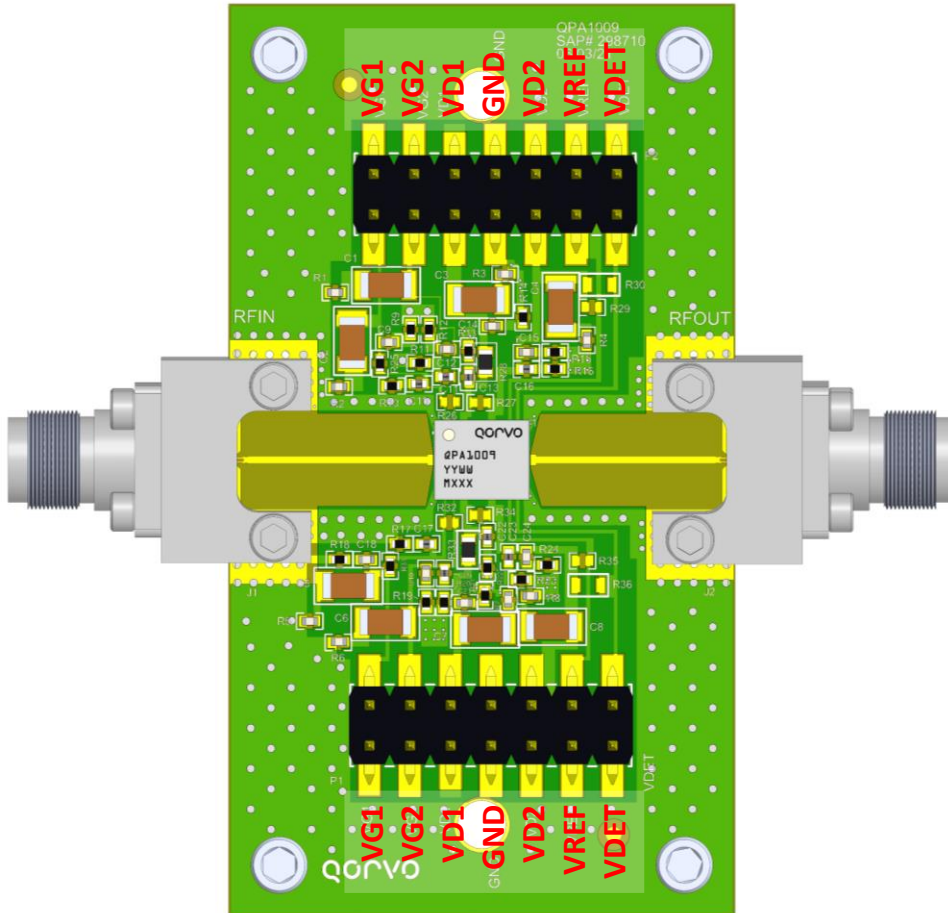

Package removed to show mounting location

Bill of Materials

Reference Des.	Value	Description	Manuf.	Part No.
C1, C2, C3, C4, C5, C6, C7, C8	10 uF	CAP, 10uF, 20%, 50V, 20%, X5R, 1206	Various	
C9, C12, C14, C15, C18, C19, C21, C24	0.01 uF	CAP, 0.01uF, 10%, 50V, X7R, 0402	Various	
C10, C11, C13, C16, C17, C20, C22, C23	1 nF	CAP, 1nF, 10%, 50V, X7R, 0402	Various	
R1, R2, R3, R4, R5, R6, R7, R8	5.1 Ω	RES, 5.1 OHM, 1%, 1/10W, 0402	Various	
R9, R10, R11, R12, R13, R14, R15, R16, R17, R18, R19, R20, R21, R22, R23, R24, R25, R31	0 Ω	RES, 0 OHM, 1/10W, 0402	Various	
R28, R33	0 Ω	RES, 0 OHM, 0603	Various	
J1, J2	2.92 mm	CONN, 2.92, END, F, PIN .005, DIEL .029	Southwest Microwave	1092-01A-5

Mechanical Information

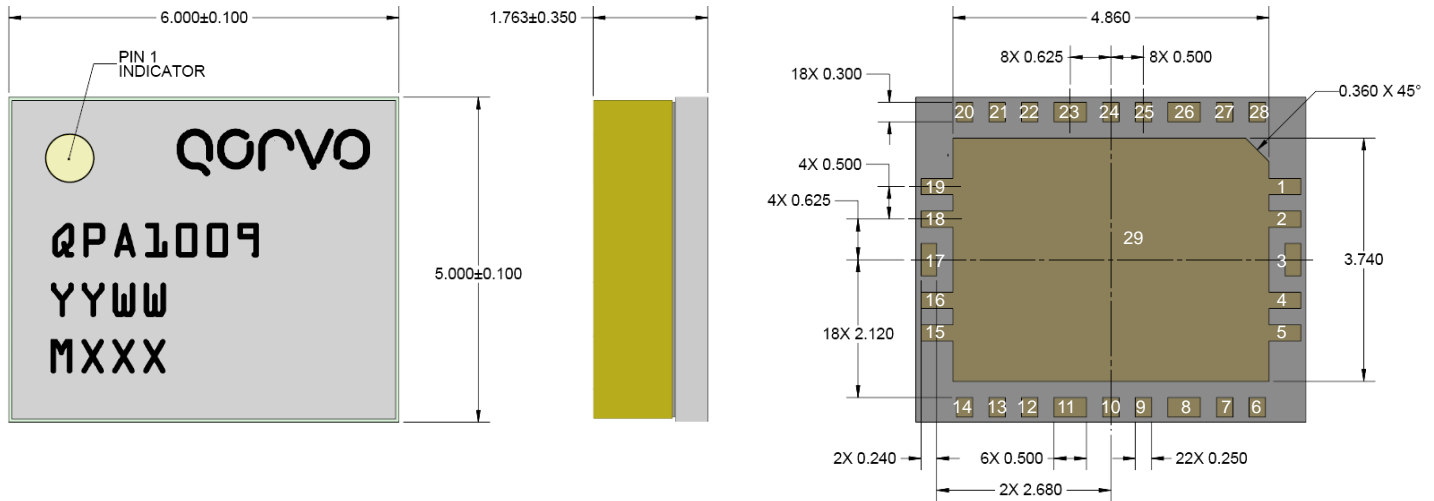

Material:

1. Package Lid: FR4
2. All package leads are gold plated
3. The part is epoxy sealed

Tolerances:

- .XX = ± .25
- .XXX = ± .100
- .XXXX = ± .0245

Unless otherwise specified, dimensions are in mm

Bond Pad Description

Pad No.	Symbol	Description
1, 2, 4, 5, 15, 16, 18, 19, 29	GND	Ground
9, 10, 12, 22, 24, 25	NC	No internal connection; may be connected to PCB ground
3	RF IN	RF input. 50 ohms. DC blocked
6, 28	VG1	First stage gate voltage
7, 27	VG2	Second stage gate voltage
8, 26	VD1	First stage drain voltage
11, 23	VD2	Second stage drain voltage
13, 21	VREF	Reference voltage for detector
14, 20	VDET	Detector voltage
17	RF OUT	RF output. 50 Ohms. DC blocked

Assembly Notes

- Compatible with lead-free soldering processes with 260°C peak reflow temperature.
- All package leads are gold plated
- Solder rework is not recommended

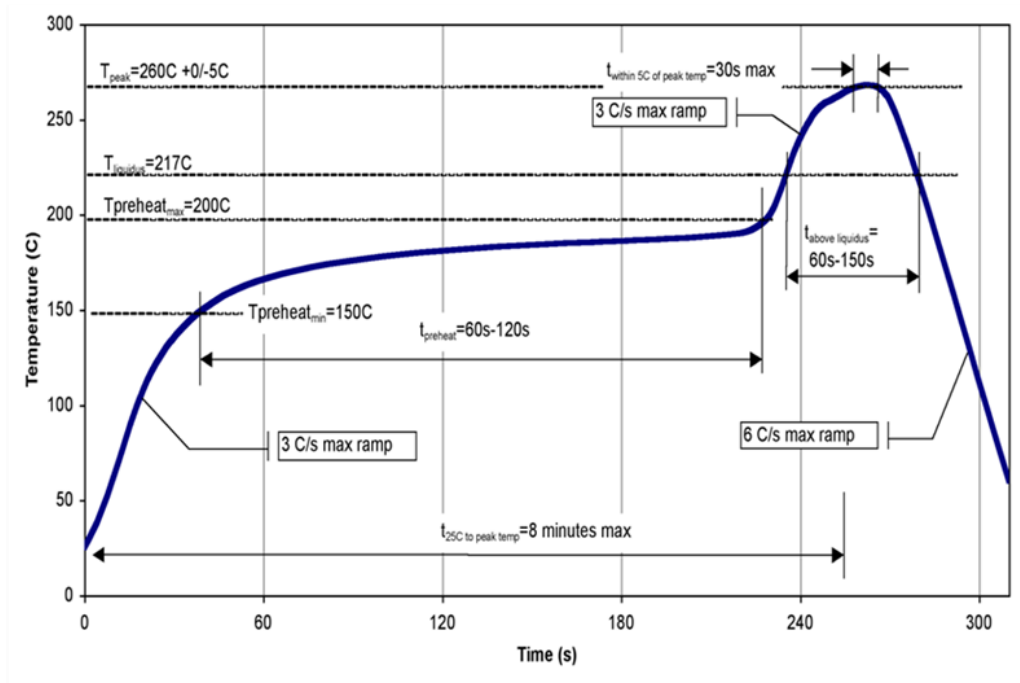

Tape and Reel Information – Carrier and Cover Tape Dimensions

Tape and reel specifications for this part are also available on the Qorvo website.
 Standard T/R size = 250 pieces on a 7" reel.

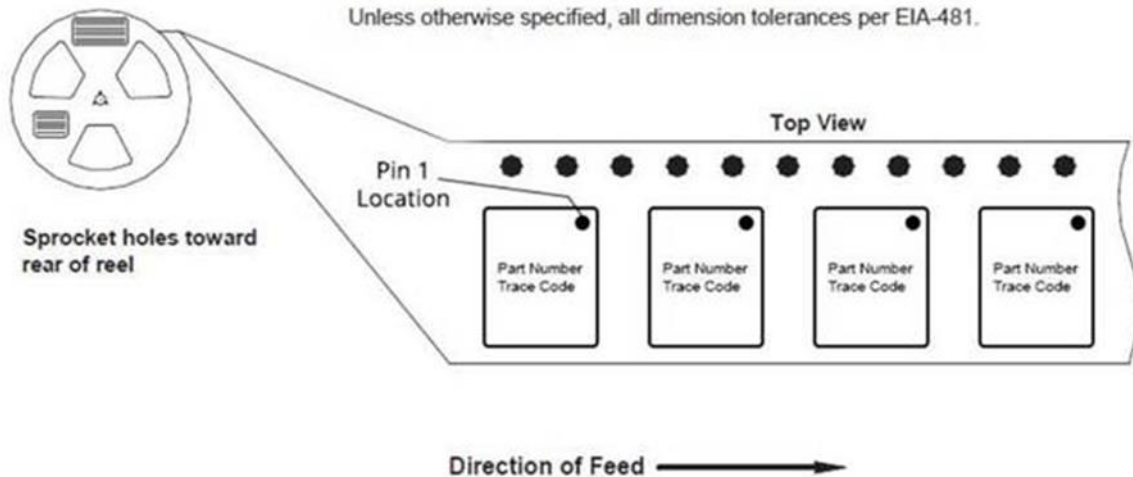

Feature	Measure	Symbol	Size (in)	Size (mm)
Cavity	Length	A0	0.209	5.3
	Width	B0	0.248	6.3
	Depth	K0	0.083	2.1
	Pitch	P1	0.315	8.0
Centerline Distance	Cavity to Perforation - Length Direction	P2	0.079	2.0
	Cavity to Perforation - Width Direction	F	0.217	5.5
Cover Tape	Width	C	0.362	9.2
Carrier Tape	Width	W	0.472	12.0

Tape and Reel Information – Reel Dimensions

Packaging reels are used to prevent damage to devices during shipping and storage, loaded carrier tape is typically wound onto a plastic take-up reel. The reel size is 7" diameter. The reels are made from high-impact injection-molded polystyrene (HIPS), which offers mechanical and ESD protection to packaged devices.

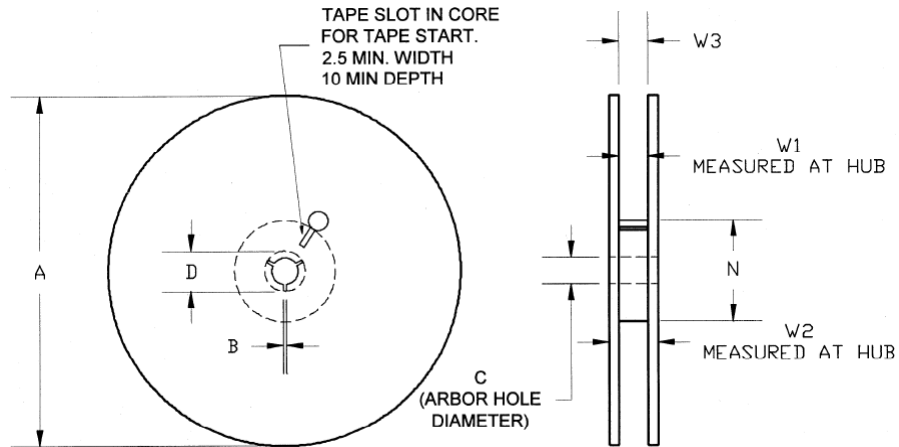

Feature	Measure	Symbol	Size (in)	Size (mm)
Flange	Diameter	A	6.969	177.0
	Thickness	W2	0.724	18.4
	Space Between Flange	W1	0.488	12.4
Hub	Outer Diameter	N	2.283	58.0
	Arbor Hole Diameter	C	0.512	13.0
	Key Slit Width	B	0.079	2.0
	Key Slit Diameter	D	0.795	20.2

Tape and Reel Information – Tape Length and Label Placement

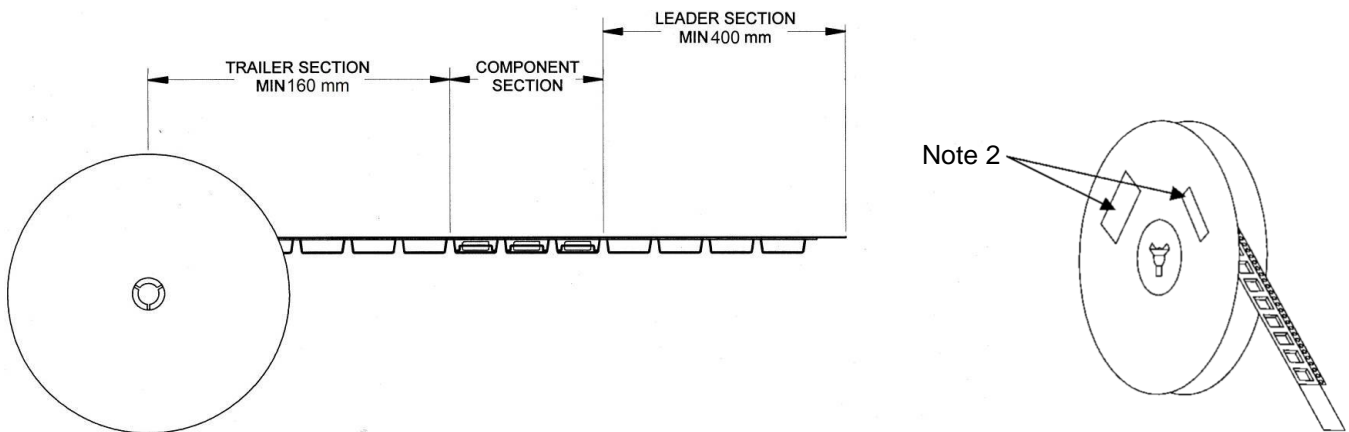

Notes:

1. Empty part cavities at the trailing and leading ends are sealed with cover tape. See EIA 481.
2. Labels are placed on the flange opposite the sprockets in the carrier tape.

Handling Precautions

Parameter	Rating	Standard
ESD – Human Body Model (HBM)	1A	ESDA / JEDEC JS-001-2017
ESD – Charge Device Model (CDM)	C3	ESDA / JEDEC JS-002-2018
MSL – Moisture Sensitivity Level	5a	JEDEC standard IPC/JEDEC J-STD-020



Caution!

ESD-Sensitive Device

Solderability

Soldering of the component pads is compatible with the latest version of J-STD-020, lead-free solder, 260 °C.

RoHS Compliance

This product is compliant with the 2011/65/EU RoHS directive (Restrictions on the Use of Certain Hazardous Substances in Electrical and Electronic Equipment), as amended by Directive 2015/863/EU. This product also has the following attributes:

- Lead Free
- Antimony Free
- TBBP-A (C15H12Br4O2) Free
- PFOS Free
- SVHC Free

Contact Information

For the latest specifications, additional product information, worldwide sales and distribution locations:

Tel: 1-844-890-8163

Web: www.qorvo.com

Email: customer.support@qorvo.com

Important Notice

The information contained herein is believed to be reliable; however, Qorvo makes no warranties regarding the information contained herein and assumes no responsibility or liability whatsoever for the use of the information contained herein. All information contained herein is subject to change without notice. Customers should obtain and verify the latest relevant information before placing orders for Qorvo products. The information contained herein or any use of such information does not grant, explicitly or implicitly, to any party any patent rights, licenses, or any other intellectual property rights, whether with regard to such information itself or anything described by such information. **THIS INFORMATION DOES NOT CONSTITUTE A WARRANTY WITH RESPECT TO THE PRODUCTS DESCRIBED HEREIN, AND QORVO HEREBY DISCLAIMS ANY AND ALL WARRANTIES WITH RESPECT TO SUCH PRODUCTS WHETHER EXPRESS OR IMPLIED BY LAW, COURSE OF DEALING, COURSE OF PERFORMANCE, USAGE OF TRADE OR OTHERWISE, INCLUDING THE IMPLIED WARRANTIES OF MERCHANTABILITY AND FITNESS FOR A PARTICULAR PURPOSE.**

Without limiting the generality of the foregoing, Qorvo products are not warranted or authorized for use as critical components in medical, life-saving, or life-sustaining applications, or other applications where a failure would reasonably be expected to cause severe personal injury or death.

© 2021 Qorvo US, Inc. All rights reserved. This document is subject to copyright laws in various jurisdictions worldwide and may not be reproduced or distributed, in whole or in part, without the express written consent of Qorvo US, Inc.