

R-GAGE™ QT50RAF Sensor

Radar-Based Adjustable Field Sensors for Detection of Moving and Stationary Targets

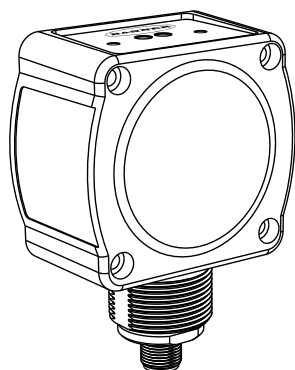

Features

- FMCW (true-presence) radar detects moving and stationary objects
- Adjustable sensing field — ignores objects beyond setpoint
- Easy setup and configuration of range, sensitivity, and output with simple DIP switches
- Sensing functions are unaffected by wind, falling rain or snow, fog, humidity, air temperatures, or light
- Sensor operates in Industrial, Scientific, and Medical (ISM) telecommunication band; no special license required
- Rugged IP67 housing withstands harsh environments



Protected by US patents

Models

Models ¹	Maximum Range	Connection	Supply Voltage	Telecom Approval ²	Output
QT50RAF-US	15 m (49 ft)	5-wire 2 m (6.5 ft) Integral cable	12 to 30V dc	Telecom approved for US, Canada, and Brazil	Bipolar NPN/PNP DIP-switch-selectable N.O. or N.C.
QT50RAF-CN				Telecom approved for China	
QT50RAF-EU				Telecom approved for Europe (except UK), Australia, New Zealand, China, and Japan	
QT50RAF-UK				Telecom approved for UK	



CAUTION: Make No Modifications to this Product

Any modifications to this product not expressly approved by Banner Engineering could void the user's authority to operate the product. **Contact the Factory for more information.**



WARNING: Not To Be Used for Personnel Protection

Never use this device as a sensing device for personnel protection. Doing so could lead to serious injury or death. This device does NOT include the self-checking redundant circuitry necessary to allow its use in personnel safety applications. A sensor failure or malfunction can cause either an energized or de-energized sensor output condition.

¹ Cabled models only are listed. For integral 5-pin Euro-style (M12) quick-disconnect fitting, add suffix "Q" to the model number (e.g., QT50RAFQ-xx). QD models require a mating cordset; see [Quick Disconnect \(QD\) Cordsets](#) on page 7.

² For additional countries, contact Banner Engineering.

Overview

The R-GAGE sensor emits a well-defined beam of high-frequency radio waves from an internal antenna. Some of this emitted energy reflects back to the receiving antenna. Signal processing electronics in the sensor determine the distance from the sensor to the object based on the time delay of the return signal. The sensor can be configured (via DIP switches) to sense objects up to a specific distance, ignoring objects beyond this distance (also called background suppression).

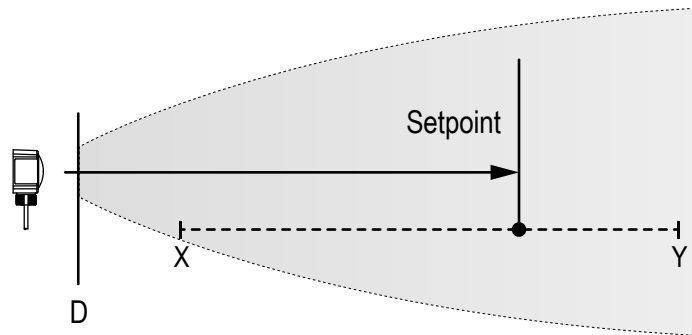

Figure 1. R-GAGE Setpoint

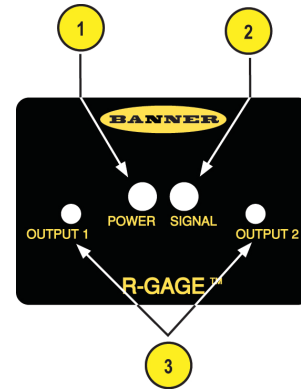

Figure 2. R-Gage Features

1. Power LED: Green (power ON)
2. Signal Strength LED: Red (flashes in proportion to the signal strength)
3. Output LEDs: Yellow (output energized); Red (configuration)

Access DIP switches behind threaded cap on sensor back (not shown)

R-GAGE setpoint distances, minimum and maximum (sensor will detect objects up to setpoint and ignore objects beyond the setpoint)

		EU, CN Models	US, UK Models
X	Minimum setpoint distance	2 m (6.6 ft)	3 m (9.8 ft)
Y	Maximum setpoint distance	15 m (49.2 ft)	15 m (49.2 ft)
D	Dead Zone*		

* Typical dead zone: 0.4 m (1.3 ft) for moving and 1.0 m (3.3 ft) for stationary targets, but varies with target reflectivity

Sensor Configuration

The sensing zone distance, sensitivity, and output configuration can be selected via the DIP switches on the back of the sensor.

Use the included spanner to open the screw-off cover on the back of the sensor and access the DIP switches.



Important: Tighten the DIP switch cover a full quarter turn after contact to maintain the watertight seal.

DIP Switch Functions

Switch	Function
1, 2, 3	Sensing distance (detects objects from sensor face to this point)
4, 5, 6	Sensitivity (higher sensitivity sees weaker objects and has a larger beam pattern)
7	Normally open/normally closed output functionality
8	Response Speed

DIP switch 1 is on the left and DIP switch 8 is on the right.

Distance Settings

* Default settings

Switch 1	Switch 2	Switch 3	Distance	
			EU, CN Models	US, UK Models
0	0	0	2 m (6.6 ft)	3 m (9.8 ft)
0	0	1	3 m (9.8 ft)	4 m (13.1 ft)
0	1	0	4 m (13.1 ft)	5 m (16.4 ft)
0	1	1	6 m (19.7 ft)	6 m (19.7 ft)
1*	0*	0*	8 m (26.2 ft)	8 m (26.2 ft)
1	0	1	10 m (32.8 ft)	10 m (32.8 ft)
1	1	0	12 m (39.4 ft)	12 m (39.4 ft)
1	1	1	15 m (49.2 ft)	15 m (49.2 ft)



NOTE: Highest sensitivity is achieved only if sensing distance is 8 m (26.2 ft) or less

Sensitivity Selection

* Default settings

Switch 4	Switch 5	Switch 6	Sensitivity
0*	0*	0*	8 (Highest)
0	0	1	7
0	1	0	6
0	1	1	5
1	0	0	4
1	0	1	3
1	1	0	2
1	1	1	1 (Lowest)



NOTE: Use the sensitivity selection to ignore unwanted weak reflections within the field of view, and not to narrow the beam width. Narrow-beam R-GAGE sensor models are available.

Output Configuration

* Default settings

Switch 7	Normally Open/Normally Closed
0*	N.O.
1	N.C.

Response Speed

* Default settings

Switch 8	ON	OFF	ON/OFF
0	32 ms	68 ms	100 ms
1*	258 ms	998 ms	1256 ms

Specifications

Range

The sensor is able to detect a proper object (see Detectable Objects) from 1 to 15 m (3.3 to 49.2 ft), depending on target

Detectable Objects

Objects containing metal, water, or similar high-dielectric materials

Operating Principle

Frequency modulated continuous-wave (FMCW) radar

Operating Frequency

24.00 to 24.25 GHz, ISM Band (varies slightly with model, depending on national telecom regulations)

Supply Voltage

12 to 30V dc, less than 100 mA, exclusive of load

Supply Protection Circuitry

Protected against reverse polarity and transient over-voltages

Delay at Power-up

Less than 2 seconds

Output Configuration

Bipolar NPN/PNP output, 150mA; DIP switch 7 selects N.O. (default) or N.C. operation

Output Protection

Protected against short circuit conditions

Response Time

DIP-Switch 8 selects ON/OFF response time

Indicators

Power LED: Green (power ON)

Signal Strength LED: Red, flashes in proportion to signal strength. Steady on at 4x excess gain. Only indicates signal amplitude, not target distance.

Output LEDs: Yellow (output energized) / Red (configuration)

See [Figure 2. R-Gage Features](#) on page 2

Adjustments

DIP-switch-configurable sensing distance, sensitivity, response time, and output configuration

Construction

Housing: ABS/polycarbonate

Lightpipes: Acrylic

Access Cap: Polyester

Operating Temperature

-40° to +65° C (-40° to +149° F)

Environmental Rating

IP67

Connections

Integral 5-wire 2 m (6.5 ft) cable or M12 Euro-style QD fitting. QD models require a mating cordset

Certifications



ETSI/EN 300 440; FCC part 15; RSS-210; ANATEL Category II; CMII Category G; ARIB STD T-73; for others, contact Banner Engineering.

FCC ID: UE3QT50RUS—This device complies with Part 15 of the FCC Rules. Operation is subject to the following two conditions; (1) this device may not cause harmful interference, and (2) this device must accept any interference received, including interference that may cause undesired operation.



Este equipamento opera em caráter secundário, isto é, não tem direito à proteção contra interferência prejudicial, mesmo de estações do mesmo tipo e não pode causar interferência a sistemas operando em caráter primário.

Windows

The R-GAGE sensor can be placed behind a glass or a plastic window, but the configuration must be tested and the distance from the sensor to the window must be determined and controlled prior to installation. There is typically a 20% signal reduction when the sensor is placed behind a window.

Polycarbonate at 4mm thickness performs well in most situations, but the performance depends on filler materials. Thinner (1 to 3 mm) windows have high reflection. The amount of reflection depends on the material, thickness, and distance from the sensor to the window.

Locate the sensor in a position of minimum reflection from the window, which will repeat every 6.1 mm of distance between the sensor and the window. The positions of maximum reflection from the window repeat between the minimums, and decrease in effect until the window is approximately 150 mm (5.9 in) away. Consult the factory for pre-tested window materials which can be used at any distance without issue.

Additionally, the face of the window should be protected from flowing water and ice by use of a flow diverter or hood directly above the window. Falling rain or snow in the air in front of the window, light water mist, or small beads on the face of the window are typically not an issue. However, a thick, continuous surface of water or ice directly on the face of the window can be detected as a dielectric boundary.

Beam Pattern

Typical Beam Pattern (with BRTR-CC20E Radar Target, Radar Cross Section = 50 m²)

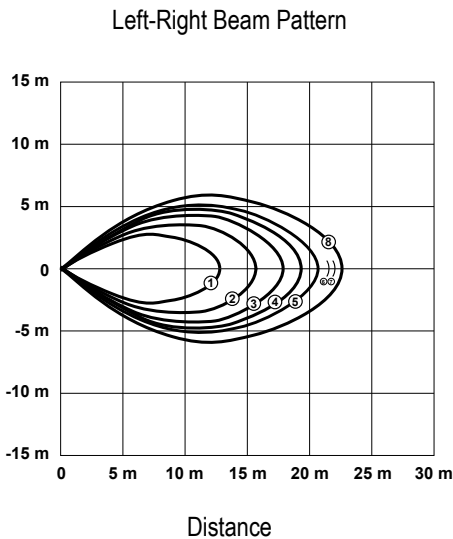

1–8: Indicates sensitivity level

Typical Beam Pattern (with 4 different targets) at highest sensitivity level

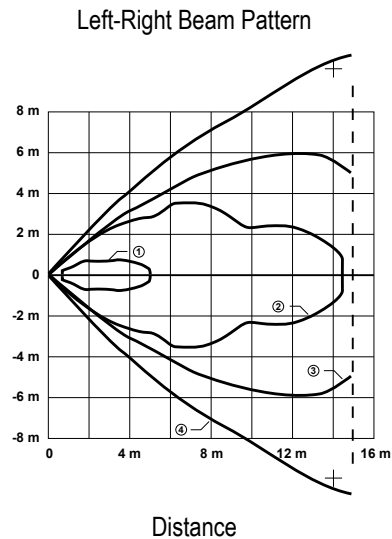

- 1: Weak Object (Radar cross section = 0.25 m²)
- 2: Car (Radar cross section = 3 m²)
- 3: Large Truck (Radar cross section = 50 m²)
- 4: Passenger Train (Radar cross section = 300 m²)



NOTE: The effective beam pattern depends on the sensitivity level and target properties.

Dimensions

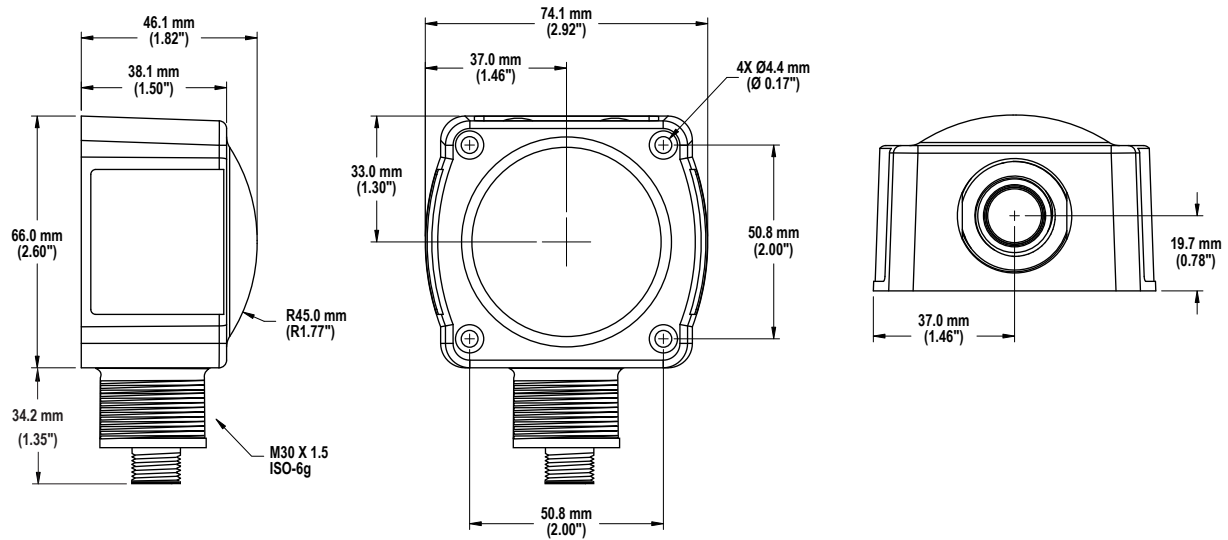

Hookup

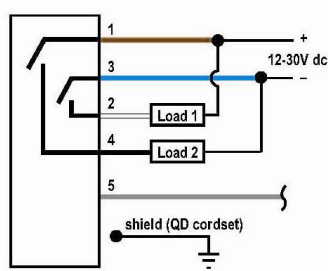

Wiring Key:

- 1 = Brown
- 2 = White
- 3 = Blue
- 4 = Black
- 5 = Gray (Do not connect)



NOTE: Banner recommends that the shield wire (QD cordsets only) be connected to earth ground or dc common. Shielded cordsets are recommended for all QD models.

Quick Disconnect (QD) Cordsets

5-Pin Threaded M12/Euro-Style Cordsets with Shield				
Model	Length	Style	Dimensions	Pinout
MQDEC2-506	1.83 m (6 ft)	Straight		<p>1 = Brown 2 = White 3 = Blue 4 = Black 5 = Gray</p>
MQDEC2-515	4.57 m (15 ft)			
MQDEC2-530	9.14 m (30 ft)			
MQDEC2-550	15.2 m (50 ft)			
MQDEC2-506RA	1.83 m (6 ft)	Right-Angle		
MQDEC2-515RA	4.57 m (15 ft)			
MQDEC2-530RA	9.14 m (30 ft)			
MQDEC2-550RA	15.2 m (50 ft)			



NOTE: Pin 5 is not used.

Mounting Brackets

<p>SMB30SC</p> <ul style="list-style-type: none"> Swivel bracket with 30 mm mounting hole for sensor Black reinforced thermo-plastic polyester Stainless steel mounting and swivel locking hardware included <p>Hole center spacing: A=∅ 50.8 Hole size: A=∅ 7.0, B=∅ 30.0</p>	<p>SMB30MM</p> <ul style="list-style-type: none"> 12-ga. stainless steel bracket with curved mounting slots for versatile orientation Clearance for M6 (1/4 in) hardware Mounting hole for 30 mm sensor <p>Hole center spacing: A = 51, A to B = 25.4 Hole size: A = 42.6 x 7, B = ∅ 6.4, C = ∅ 30.1</p>
--	--

Weather Deflector

<p>QT50RCK</p> <ul style="list-style-type: none"> Required if the R-GAGE is exposed to rain or snow Prevents buildup of water or ice from interfering with sensor performance 	
--	--

Banner Engineering Corp Limited Warranty

Banner Engineering Corp. warrants its products to be free from defects in material and workmanship for one year following the date of shipment. Banner Engineering Corp. will repair or replace, free of charge, any product of its manufacture which, at the time it is returned to the factory, is found to have been defective during the warranty period. This warranty does not cover damage or liability for misuse, abuse, or the improper application or installation of the Banner product.

THIS LIMITED WARRANTY IS EXCLUSIVE AND IN LIEU OF ALL OTHER WARRANTIES WHETHER EXPRESS OR IMPLIED (INCLUDING, WITHOUT LIMITATION, ANY WARRANTY OF MERCHANTABILITY OR FITNESS FOR A PARTICULAR PURPOSE), AND WHETHER ARISING UNDER COURSE OF PERFORMANCE, COURSE OF DEALING OR TRADE USAGE.

This Warranty is exclusive and limited to repair or, at the discretion of Banner Engineering Corp., replacement. **IN NO EVENT SHALL BANNER ENGINEERING CORP. BE LIABLE TO BUYER OR ANY OTHER PERSON OR ENTITY FOR ANY EXTRA COSTS, EXPENSES, LOSSES, LOSS OF PROFITS, OR ANY INCIDENTAL, CONSEQUENTIAL OR SPECIAL DAMAGES RESULTING FROM ANY PRODUCT DEFECT OR FROM THE USE OR INABILITY TO USE THE PRODUCT, WHETHER ARISING IN CONTRACT OR WARRANTY, STATUTE, TORT, STRICT LIABILITY, NEGLIGENCE, OR OTHERWISE.**

Banner Engineering Corp. reserves the right to change, modify or improve the design of the product without assuming any obligations or liabilities relating to any product previously manufactured by Banner Engineering Corp.