

50Ω DC to 26.5 GHz

The Big Deal

- Dual independent mechanical SPDT switches
- Excellent performance to 26.5 GHz
- High reliability, 10 million switch cycles
- 20W power rating (cold switching)



Case Style: LM1849



Software Package

RoHS Compliant

See our web site for RoHS Compliance methodologies and qualifications

Typical Applications

- 5G node / device testing
- Automated test equipment
- Fail-safe / redundancy switching

Product Overview

Mini-Circuits' RC-2SPDT-A26 comprises of two independently controlled, electro-mechanical SPDT switches. Each switch operates over an extremely wide bandwidth, from DC to 26.5 GHz with high isolation and low insertion loss. The absorptive switches are of a failsafe and break-before-make-configuration, with a lifetime of 10 million switching cycles per switch when used within the noted specifications.

The switch box is constructed in a compact, rugged metal case (4.5 x 6.0 x 2.25") with all SMA (f) RF connectors on the front panel. The switches are controlled via USB or Ethernet, allowing control directly from a PC, or remotely over a network. Full software support is provided, including our user-friendly GUI application for Windows and a full API with programming instructions for Windows and Linux environments (both 32-bit and 64-bit systems).

Key Features

Feature	Advantages
Two mechanical SPDT switches	Mechanical absorptive switches provide high reliability, repeatable high performance and internal terminations of input signals on the disconnected paths
Operation from DC to 26.5 GHz	Supports a wide range of RF test and signal routing applications, including 2G, 3G, 4G and 5G, with a single device
Break-before-make configuration	Prevents a momentary connection of the old and new signal paths, reducing the inconsistent transient effects that could otherwise be observed during switching
USB & Ethernet control	USB HID and Ethernet (HTTP / Telnet) interfaces provide easy compatibility with a wide range of software setups and programming environments
Full software support	User friendly Windows GUI (graphical user interface) allows manual control straight out of the box, while the comprehensive API (application programming interface) with examples and instructions allows easy automation in most programming environments

Electrical Specifications at 25°C

Parameter	Conditions (GHz)	Min.	Typ.	Max.	Units
Frequency Range		DC		26.5	GHz
Insertion Loss	DC - 8	—	0.15	0.3	dB
	8 - 18	—	0.3	0.5	
	18 - 26.5	—	0.6	0.8	
Isolation	DC - 8	75	90	—	dB
	8 - 18	60	66	—	
	18 - 26.5	55	65	—	
VSWR	DC - 8	—	1.2	—	:1
	8 - 18	—	1.2	—	
	18 - 26.5	—	1.25	—	
Switching Time	—	—	25	—	ms
RF Input Power (Cold Switching) ¹	DC - 26.5 GHz	—	—	20	W
Switch Lifetime (per switch)	100mW hot switching ²	—	10	—	million cycles
	1W hot switching	—	3	—	
Rated Voltage	24V _{DC} input	23	24	25	V
	USB port	—	5	—	
Rated Current (24V DC Input)	All switches in state 2	—	440	610	mA
	All switches in state 1	—	90	120	
Rated Current (USB)		—	10	20	mA

¹ Maximum power for any connected through path as stated; maximum power into any internal termination is 1W per port.

² Hot switching powers above this level will degrade the switch lifetime.

Absolute Maximum Ratings

Operating Temperature	0°C to 40°C
Storage Temperature	-15°C to 85°C
Supply Voltage	26V

Switching Configuration (Per Switch):

- Normally open (all port disconnected)
- Absorptive (internal terminations on ports J1-J2)

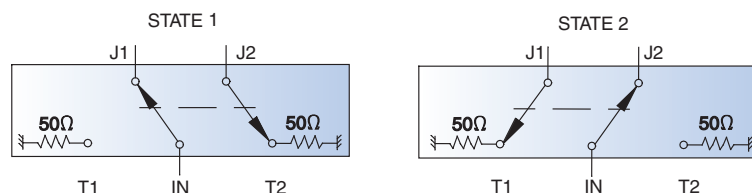

Connections

Port Name	Connector Type
RF Switch A (Com, 1 & 2)	SMA female
RF Switch B (Com, 1 & 2)	SMA female
USB	USB type-B
Ethernet / LAN	RJ45
24V _{DC} Input	2.1mm center positive DC socket

Typical Performance Data

FREQ. (MHz)	ON INSERTION LOSS (dB)		OFF ISOLATION (dB)		VSWR, IN (:1)		VSWR (J2) (:1)		VSWR (J1) (:1)	
	IN-J2	IN-J1	IN-J1	IN-J2	State 1	State 2	State 1	State 2	State 1	State 2
100	0.03	0.02	101.07	101.45	1.01	1.00	1.01	1.01	1.01	1.01
1000	0.07	0.06	101.54	108.83	1.03	1.04	1.03	1.03	1.03	1.03
2000	0.10	0.09	104.68	101.84	1.05	1.06	1.05	1.05	1.05	1.05
4000	0.13	0.13	107.89	100.01	1.09	1.11	1.11	1.09	1.11	1.09
6000	0.16	0.15	103.35	105.41	1.15	1.17	1.13	1.13	1.13	1.13
8000	0.19	0.17	92.85	101.05	1.12	1.12	1.07	1.09	1.08	1.10
10000	0.20	0.19	96.31	94.29	1.05	1.05	1.06	1.07	1.03	1.07
12000	0.24	0.23	94.19	94.70	1.09	1.08	1.14	1.09	1.08	1.12
14000	0.27	0.25	86.97	87.67	1.14	1.13	1.23	1.09	1.21	1.14
16000	0.29	0.28	85.28	84.37	1.11	1.08	1.23	1.04	1.24	1.08
18000	0.32	0.31	79.13	78.52	1.09	1.06	1.27	1.06	1.28	1.08
20000	0.37	0.35	76.54	76.74	1.19	1.18	1.20	1.19	1.33	1.19
22000	0.41	0.38	73.35	72.90	1.28	1.24	1.06	1.19	1.12	1.22
24000	0.42	0.41	67.25	67.23	1.04	1.03	1.23	1.04	1.17	1.07
26500	0.52	0.55	64.92	64.81	1.19	1.22	1.40	1.17	1.33	1.21

INSERTION LOSS

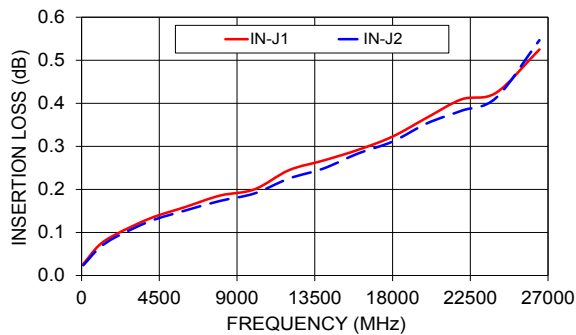

ISOLATION

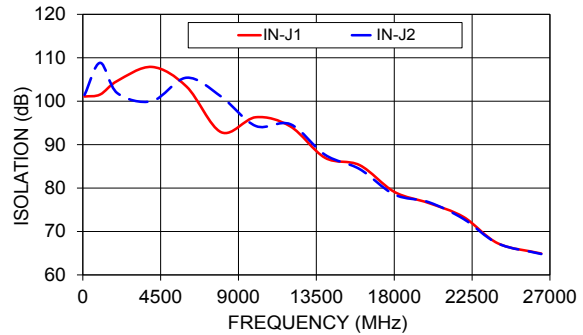

VSWR (J1)

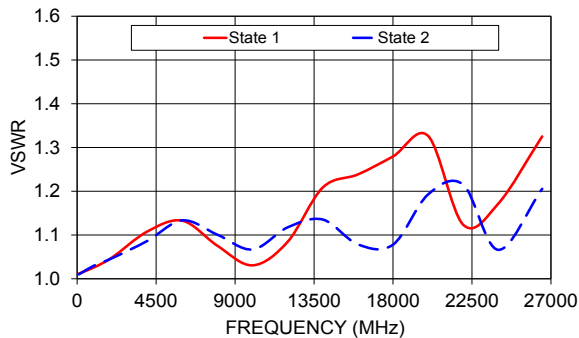

VSWR (J2)

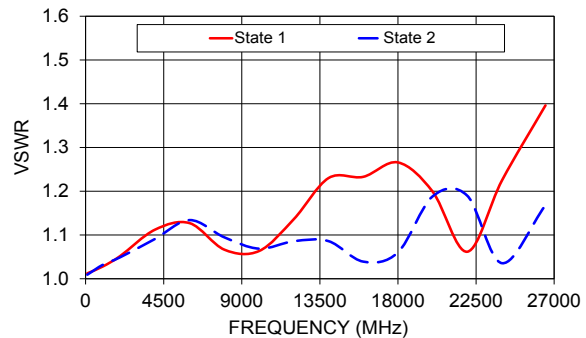

Outline Drawing (LM1849)

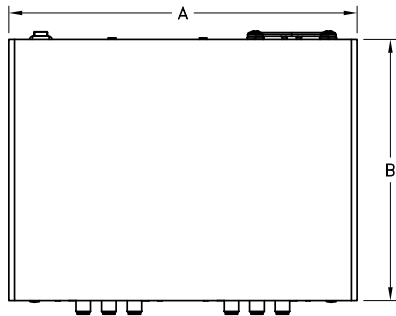

TOP VIEW

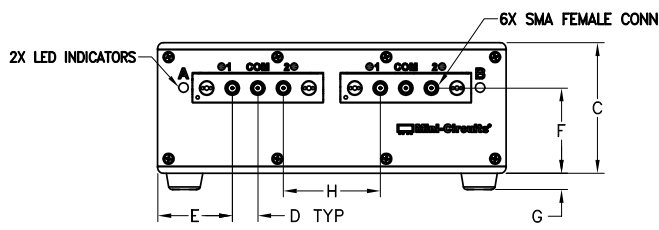

FRONT VIEW

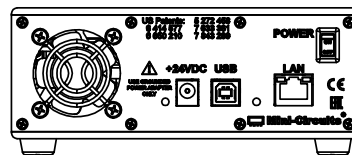

REAR VIEW

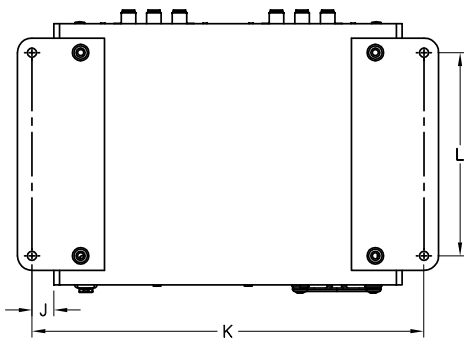

BOTTOM VIEW

SHOWN WITH RUBBER FEET REMOVED AND BRACKETS INSTALLED.

BRACKET OPTION ONE SET OF 2 EACH

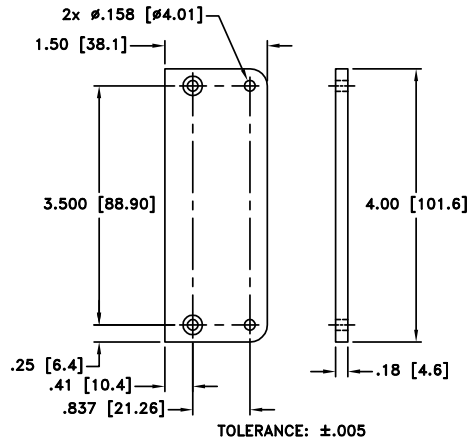

TOLERANCE: ±.005

INSTRUCTION FOR MOUNTING BRACKETS:
TOOL REQUIRED: PHILLIPS HEAD SCREW DRIVER
STEP 1: REMOVE RUBBER FEET FROM THE BOTTOM OF THE UNIT, DO NOT DISCARD THE FASTENERS.
STEP 2: MOUNT THE BRACKETS WITH THE FASTENERS REMOVED IN STEP 1, USING THE COUNTER BORE HOLES IN THE BRACKET.

Outline Dimensions (inch mm)

A	B	C	D	E	F	G	H	J	K	L	wt
6.00	4.50	2.25	.440	1.285	1.47	.28	1.670	.375	.675	3.500	grams
152.4	114.3	57.2	11.18	32.6	37.3	7.1	42.42	9.53	17.15	88.9	980

Software Specifications

Software & Documentation Download:

- Mini-Circuits' full software and support package including user guide, Windows GUI, DLL files, programming manual and examples can be downloaded free of charge from <https://www.minicircuits.com/softwaredownload/rfswitchcontroller.html>
- Please contact testsolutions@minicircuits.com for support

Minimum System Requirements:

Parameter	Requirements	
Interface	USB HID & Ethernet (HTTP & Telnet)	
System Requirements	GUI	Windows 98 or later
	USB API DLL	Windows 98 or later and programming environment with ActiveX or .NET support
	USB Direct Programming	Linux, Windows 98 or later
	Ethernet	Windows, Linux or Mac computer with a network port and Ethernet TCP/IP support
Hardware	Pentium II or later with 256 MB RAM	

Application Programming Interface (API)

Ethernet Support:

- Simple ASCII / SCPI command set for attenuator control
- Communication via HTTP or Telnet
- Supported by most common programming environments

USB Support (Windows):

- ActiveX COM DLL file for creation of 32-bit programs
- .NET library DLL file for creation of 32 / 64-bit programs
- Supported by most common programming environments (refer to application note AN-49-001 for summary of supported environments)

USB Support (Linux):

- Direct USB programming using a series of USB interrupt codes

Full programming instructions and examples available for a wide range of programming environments / languages.

Graphical User Interface (GUI) for Windows - Key Features

- Connect via USB or Ethernet
- Run GUI in “demo mode” to evaluate software without a hardware connection

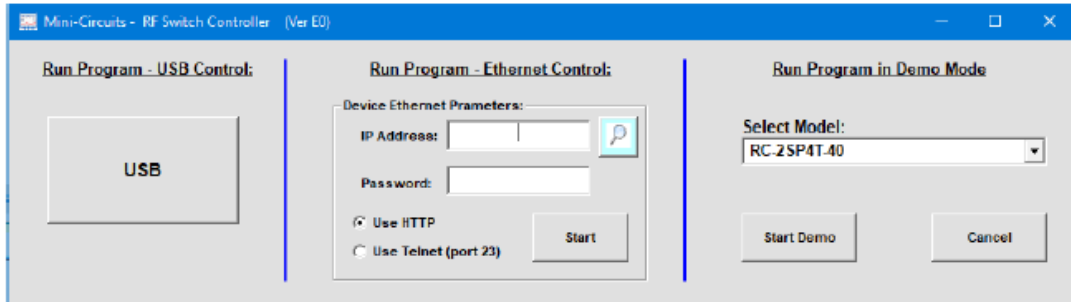

- View and set switch states at the click of a button
- Configure and run timed switching sequences
- Set start-up switch state
- Configure Ethernet IP Settings

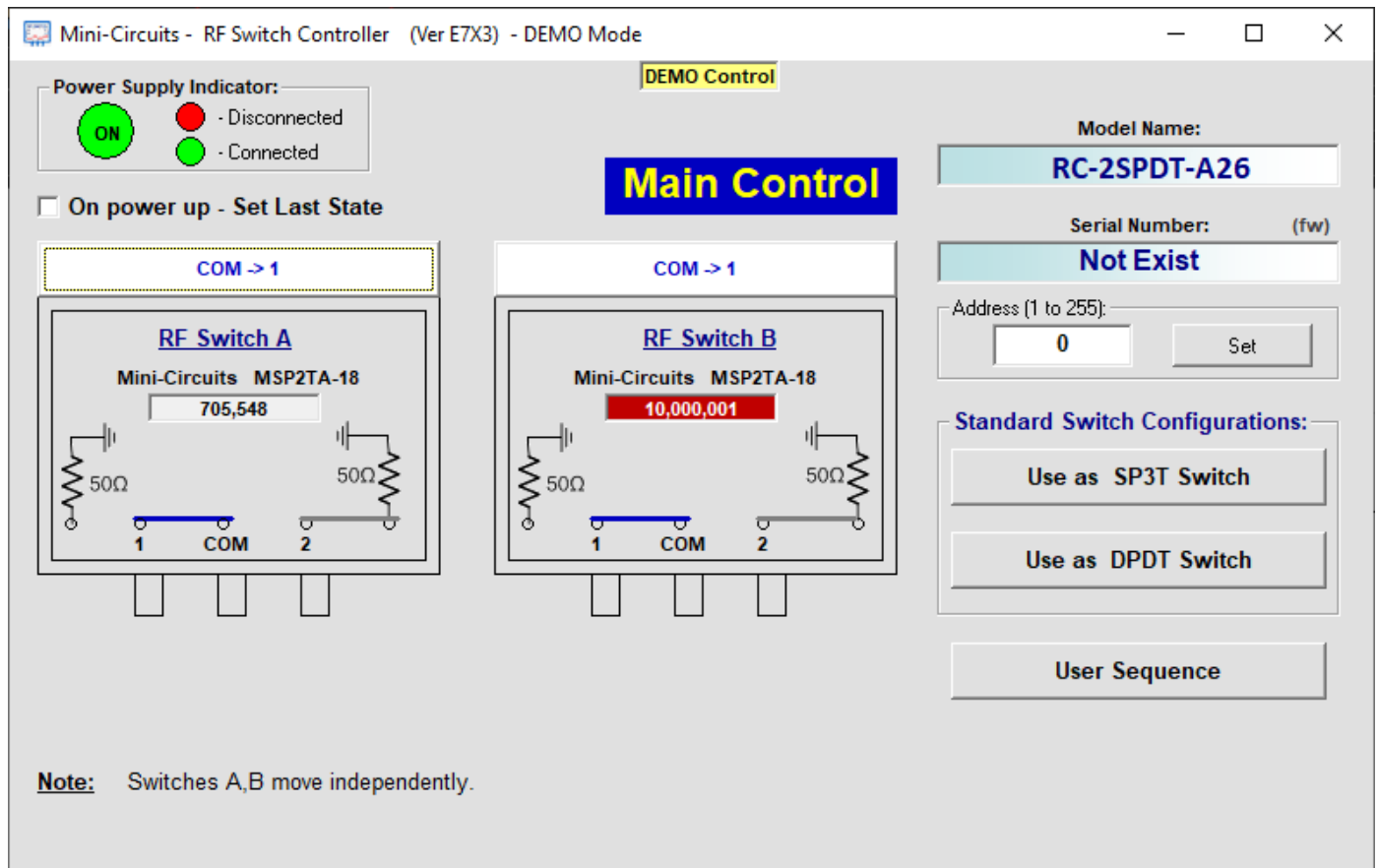









Ordering Information

Refer to Mini-Circuits' website for pricing and availability information:

<https://www.minicircuits.com/WebStore/dashboard.html?model=RC-2SPDT-A26>

Model	Description
RC-2SPDT-A26	USB & Ethernet controlled 2 x SPDTswitch matrix

Included Accessories	Part No.	Description
	AC/DC-24-3W1	AC/DC 24V _{DC} Grounded Power Adaptor. Operating temperature: 0°C to +40°C, I _{Max} =2.5A
	CBL-3W1-XX	AC Power Cord (Select one power cord from below with each Switch Matrix box)
	USB-CBL-AB-3+	2.7 ft (0.8 m) USB Cable: USB type A(Male) to USB type B(Male)

AC Power Cords ⁵	Part No.	Description
	CBL-3W1-US	Power Cord for United States
	CBL-3W1-EU	Power Cord for Europe
	CBL-3W1-UK	Power Cord for United Kingdom
	CBL-3W1-AU	Power Cord for Australia and China
	CBL-3W1-IL	Power Cord for Israel

⁵ If you need a Power cord for a country not listed please contact testsolutions@minicircuits.com

Optional Accessories	Description
USB-CBL-AB-3+	2.7 ft (0.8 m) USB Cable: USB type A(Male) to USB type B(Male)
USB-CBL-AB-7+	6.8 ft (2.1 m) USB Cable: USB type A(Male) to USB type B(Male)
USB-CBL-AB-11+	11 ft (3.4 m) USB Cable: USB type A(Male) to USB type B(Male)
CBL-RJ45-MM-5+	5 ft (1.5 m) Ethernet cable: RJ45(Male) to RJ45(Male) Cat 5E cable
BKT-272-08+	Bracket (One set of 2 each)

Additional Notes

- Performance and quality attributes and conditions not expressly stated in this specification document are intended to be excluded and do not form a part of this specification document.
- Electrical specifications and performance data contained in this specification document are based on Mini-Circuit's applicable established test performance criteria and measurement instructions.
- The parts covered by this specification document are subject to Mini-Circuits standard limited warranty and terms and conditions (collectively, "Standard Terms"); Purchasers of this part are entitled to the rights and benefits contained therein. For a full statement of the Standard Terms and the exclusive rights and remedies thereunder, please visit Mini-Circuits' website at www.minicircuits.com/MCLStore/terms.jsp

