

Solid State Relays 1-Phase with Integrated Heatsink Zero Cross Switching Types RGH Solid State Contactor

CARLO GAVAZZI



- Product width ranging from 17.5mm to 70mm
- Rated Operational voltage: Up to 600 VAC
- Rated Operational current: Up to 60 AAC @ 40°C
- Up to 6600 A²s for I²t and 1600Vp blocking voltage
- Control voltages: 4-32 VDC, 20-275 VAC (24-190 VDC)
- IP20 protection
- Design according to EN/IEC60947-4-2, EN/IEC60947-4-3, EN/IEC62314, UL508, CSA22-2 No14-10
- Integrated voltage transient protection with Varistor
- RoHS compliant
- Short circuit current rating: 100kA
- VDE approval

Product Description

This range of Solid State contactors offers the possibility of 1600Vp blocking voltage as well as the use of a less expensive means for short circuit protection due to the use of semiconductors with high I²t ratings combined with a small

width dimension for the product which can go as narrow as 17.5mm for the 20A version. The nominal current ratings are at 40°C.

Specifications are stated at 25°C unless otherwise stated.

Ordering Key **RGH 1 A 60 A 31 K K E**

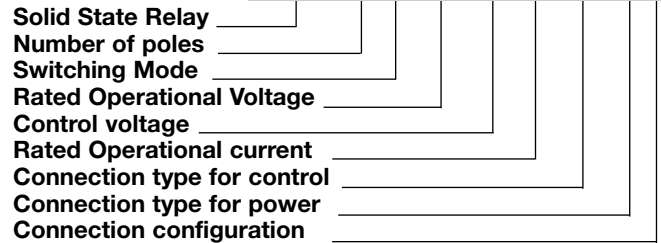

Ordering Key

1Phase SSR with heatsink	Rated Voltage	Control Voltage	Rated Current	Connection		Connection configuration
				Control	Power	
RGH1A: ZC	60: 600V +10% - 15%, 1600Vp	D: 4-32VDC A: 20-275VAC, 24-190VDC	15: 23AAC, 6600A ² s	K: Screw	K: Screw	E: Contactor
			20: 23AAC, 1800A ² s	M: Pluggable	G: Box Clamp	U: SSR
			21: 23AAC, 6600A ² s	Spring-loaded		
			31: 30AAC, 6600A ² s			
			40: 40AAC, 1800A ² s			
			41: 40AAC, 6600A ² s			
			60: 60AAC, 6600A ² s			

Selection Guide (ZC = Zero Cross Switching)

Rated Output Voltage	Blocking Voltage	Connection Control/ Power	Control Voltage	Connection Type	Rated Operational Current @ 40°C (I ² t value in brackets)			
					23 AAC (6600 A ² s)	23 AAC (1800 A ² s)	23 AAC (6600 A ² s)	30 AAC (6600 A ² s)
600VAC, ZC	1600Vp	Screw/ Screw	4-32VDC	E-type	RGH1A60D15KKE	RGH1A60D20KKE	RGH1A60D21KKE	RGH1A60D31KKE
				E-type	RGH1A60D15MKE	RGH1A60D20MKE	RGH1A60D21MKE	RGH1A60D31MKE
		Screw/ Screw	20-275VAC, 24-190VDC	E-type	RGH1A60A15KKE	RGH1A60A20KKE	RGH1A60A21KKE	RGH1A60A31KKE
				E-type	RGH1A60A15MKE	RGH1A60A20MKE	RGH1A60A21MKE	RGH1A60A31MKE
		Spring/ Screw	20-275VAC, 24-190VDC	E-type				
				E-type				

Rated Output Voltage	Blocking Voltage	Connection Control/ Power	Control Voltage	Connection Type	Rated Operational Current @ 40°C (I ² t value in brackets)		
					40 AAC (1800 A ² s)	40 AAC (6600 A ² s)	60 AAC (6600 A ² s)
600VAC, ZC	1600Vp	Screw/ Box clamp	4-32VDC	E-type	RGH1A60D40KGE	RGH1A60D41KGE	RGH1A60D60KGE
				E-type	-	RGH1A60D41KGU	RGH1A60D60KGU
		Spring/ Box clamp	4-32VDC	E-type	-	RGH1A60D41MGE	-
				E-type	RGH1A60A40KGE	RGH1A60A41KGE	RGH1A60A60KGE
		Screw/ Box clamp	20-275VAC, 24-190VDC	E-type	-	RGH1A60A41KGU	RGH1A60A60KGU
				E-type	-	RGH1A60A41MGE	-



Output Voltage Specifications

Operational voltage range	42-600 VAC, +10% -15% on maximum
Blocking voltage	1600 Vp
Internal varistor	680 V

Environmental Specifications

Operating Temperature	-40°C to 80°C (-40°F to +176°F)
Storage Temperature	-40°C to 100°C (-40°F to +212°F)
RoHS (2002/95/EC)	Compliant
Impact resistance (EN 50155, EN 61373)	15/11 g/ms
Vibration resistance (2-100Hz, IEC60068-2-26, EN50155, EN61373)	2g per axis
Relative humidity	95% non-condensing @ 40°C
UL flammability rating (housing)	UL 94 V0

General Specifications

Latching voltage (across L1-T1)	20V
Operational frequency range	45 to 65Hz
Power factor	> 0.5 @ Vrated
Touch Protection	IP20
Control input status	continuously ON Green LED, when control input is applied

Pollution degree	2 (non-conductive pollution with possibilities of condensation)
Over-voltage category	III (fixed installations)
Isolation Input to Output Input&Output to Case	4000Vrms 4000Vrms

Input specifications

	RGH..D.. ¹	RGH..A..
Control voltage range	4 - 32 VDC	20 - 275 VAC, 24 (-10%) - 190VDC
Pick-up voltage	3.8 VDC	20VAC/DC
Drop-out voltage	1 VDC	5VAC/DC
Maximum Reverse voltage	32 VDC	-
Response time pick-up	0.5 cycle + 500µs @ 24VDC	2 cycles @ 230VAC/110VDC
Response time drop-out	0.5 cycle + 500µs @ 24VDC	0.5 cycle + 40ms @ 230VAC/ 110VDC
Input current @ 40°C	See diagrams below	See diagrams below

RG..D..

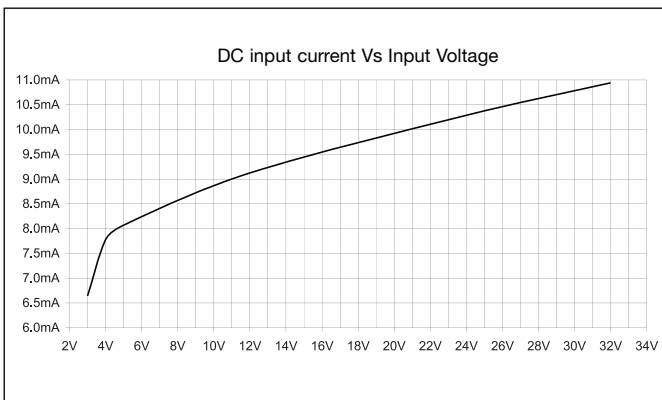

RG..A..

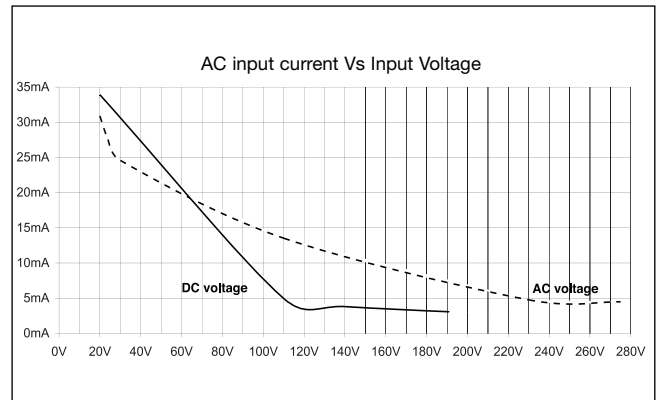

1: DC control to be supplied by a Class 2 power source

Motor Ratings: HP (UL508) / kW (EN/IEC60947-4-2) @ 40°C

	115 VAC	230 VAC	400 VAC	480 VAC	600 VAC
RGH..15	1/3HP / 0.18kW	1HP / 0.37kW	2HP / 0.75kW	3HP / 1.1kW	3HP / 1.5kW
RGH..20/21	1/2HP / 0.18kW	1-1/2HP / 0.37kW	2HP / 0.75kW	3HP / 1.1kW	3HP / 1.5kW
RGH..31	3/4HP / 0.37kW	2HP / 1.1kW	3HP / 1.5kW	5HP / 2.2kW	5HP / 3.7kW
RGH..40	3/4HP / 0.37kW	2HP / 1.1kW	3HP / 1.5kW	5HP / 2.2kW	5HP / 3.7kW
RGH..41	1 1/2HP / 0.56kW	3HP / 1.5kW	5HP / 2.2kW	7 1/2HP / 3.7kW	10HP / 4kW
RGH..60	2HP / 0.75kW	3HP / 1.5kW	5HP / 4kW	7 1/2HP / 4kW	10HP / 5.5kW

Output Specifications (@ 25°C unless otherwise specified)

	RGH..15	RGH..20	RGH..21	RGH..31	RGH..40	RGH..41	RGH..60
Rated operational current AC-51 rating @ Ta=25°C	23 AAC	25.5 AAC	25.5 AAC	30 AAC	43.7 AAC	49 AAC	75 AAC
AC-51 rating @ Ta=40°C	23 AAC	23 AAC	23 AAC	30 AAC	40 AAC	40 AAC	60 AAC
AC-53a rating @ Ta=40°C	5 AAC	5 AAC	5 AAC	10 AAC	10 AAC	13 AAC	18 AAC
Number of motor starts (x:6, Tx:6s, F:50%) at 40°C ²	30	30	30	30	30	30	30
Min. operational current	400 mAAC	250 mAAC	400 mAAC	400 mAAC	250 mAAC	400 mAAC	400 mAAC
Rep. overload current - (Motor Rating) PF = 0.4 - 0.5 UL508: T _{AMB} =40°C, t _{ON} =1s, t _{OFF} =9s, 50cycles	51 AAC	60 AAC	60 AAC	84 AAC	84 AAC	126 AAC	144 AAC
Maximum transient surge current (I _{TSM}), t=10ms	1150 Ap	600 Ap	1150 Ap	1150 Ap	600 Ap	1150 Ap	1150 Ap
Maximum off-state leakage current at rated voltage	3 mA	3 mA	3 mA	3 mA	3 mA	3 mA	3 mA
I ² t for fusing (t=10ms) Min.	6600 A ² s	1800 A ² s	6600A ² s	6600A ² s	1800A ² s	6600A ² s	6600A ² s
Critical dv/dt (@ T _j init = 40°C)	1000 V/us	1000 V/us	1000 V/us	1000 V/us	1000 V/us	1000 V/us	1000 V/us

² Overload current profile definition:
x: multiple of AC53a rating, Tx: duration of current surge, F: duty cycle

Output Power Dissipation

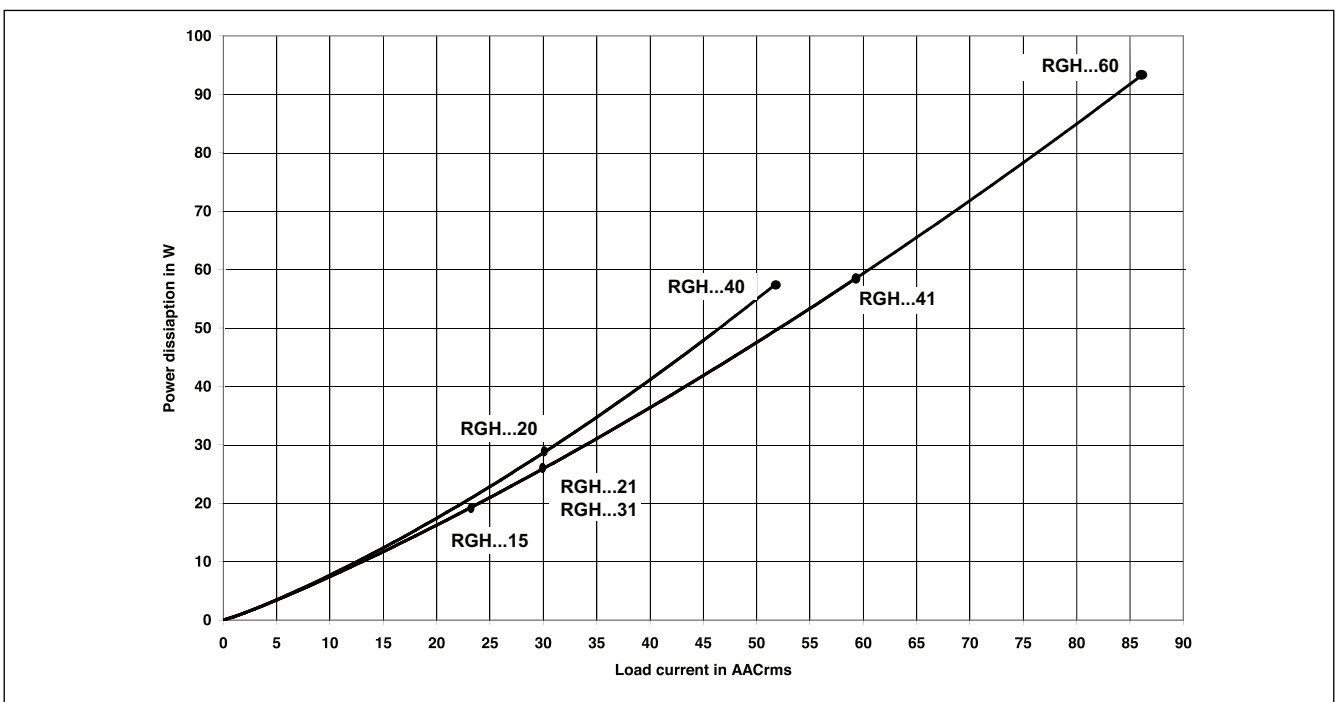

Agency Approvals and Conformances

Conformance 	IEC/EN 62314 IEC/EN 60947-4-2 IEC/EN 60947-4-3	Agency Approvals UL508 Listed (E172877) cUL Listed (E172877) VDE (0660-109) Short Circuit Current rating 100kA, UL508
---	--	---

Electromagnetic Compatibility

EMC Immunity Electrostatic Discharge (ESD) Immunity Air discharge, 8kV Contact, 4kV Electrical Fast Transient (Burst) Immunity Output: 2kV, 5kHz Input: 1kV, 5kHz Electrical Surge Immunity Output, line to line, 1kV Output, line to earth, 2kV Performance Criteria 1 Input, line to line, 1kV Input, line to earth, 2kV Performance Criteria 2	IEC/EN 61000-6-2 IEC/EN 61000-4-2 Performance Criteria 1 Performance Criteria 1 IEC/EN 61000-4-4 Performance Criteria 1 Performance Criteria 1 IEC/EN 61000-4-5 Performance Criteria 1 Performance Criteria 1 Performance Criteria 2 Performance Criteria 2	Immunity 10V/m, 80 - 1000 MHz 10V/m, 1.4 - 2.0GHz 3V/m, 2.0 - 2.7GHz Conducted Radio Frequency Immunity 10V/m, 0.15 - 80 MHz Voltage Dips Immunity 0% for 10ms/20ms, 40% for 200ms 70% for 500ms Voltage Interruptions Immunity 0% for 5000ms	IEC/EN 61000-4-3 Performance Criteria 1 Performance Criteria 1 Performance Criteria 1 IEC/EN 61000-4-6 Performance Criteria 1 IEC/EN 61000-4-11 Performance Criteria 2 Performance Criteria 2 Performance Criteria 2 IEC/EN 61000-4-11 Performance Criteria 2
Radiated Radio Frequency EMC Emission Radio Interference Voltage Emission (Conducted) 0.15 - 30MHz	EN/IEC 61000-6-4 IEC/EN 55011 Class A (industrial) with filters - see filter information IEC/EN 60947-4-2, 60947-4-3 Class A (no filtering needed)	Radio Interference Field Emission (Radiated) 30 - 1000MHz	IEC/EN 55011 Class A (industrial)

Filtering - EN / IEC 55011 Class A compliance (for class B compliance contact us)

Part Number	Suggested filter for compliance	Maximum Heater current
RGH1A60..15	220 nF / 760 V / X1	20A
RGH1A60..20	150 nF / 760 V / X1	20A
RGH1A60..21	220 nF / 760 V / X1	20A
RGH1A60..31	220 nF / 760 V / X1	30A
RGH1A60..40/41	330 nF / 760 V / X1	40A
RGH1A60..60	330 nF / 760 V / X1 470 nF / 760 V / X1	40A 65A

Note:

- Control input lines must be installed together to maintain products' susceptibility to Radio Frequency interference.
- Use of AC solid state relays may, according to the application and the load current, cause conducted radio interferences. Use of mains filters may be necessary for cases where the user must meet E.M.C requirements. The capacitor values given inside the filtering specification tables should be taken only as indications, the filter attenuation will depend on the final application.
- Performance Criteria 1: No degradation of performance or loss of function is allowed when the product is operated as intended.
- Performance Criteria 2: During the test, degradation of performance or partial loss of function is allowed. However when the test is complete the product should return operating as intended by itself.
- Performance Criteria 3: Temporary loss of function is allowed, provided the function can be restored by manual operation of the controls.

Filter Connection Diagrams

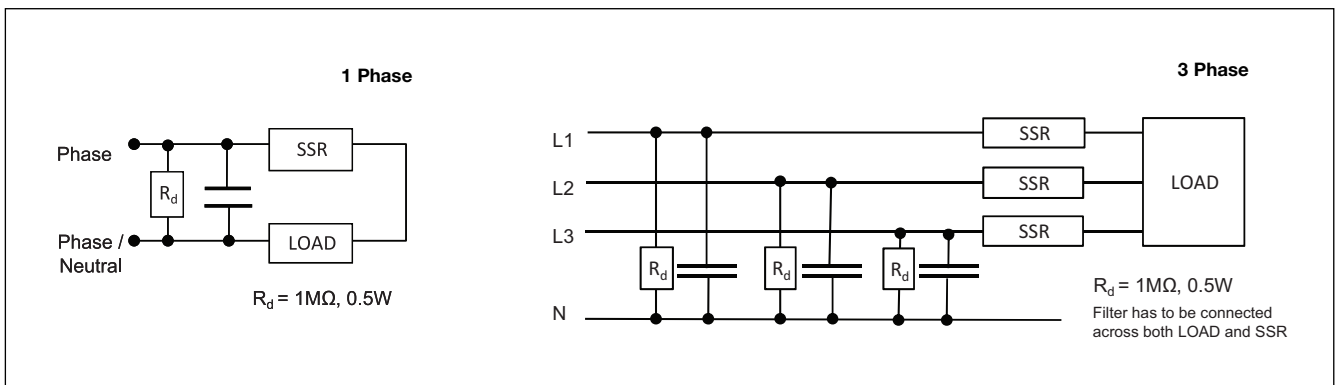

Current Derating

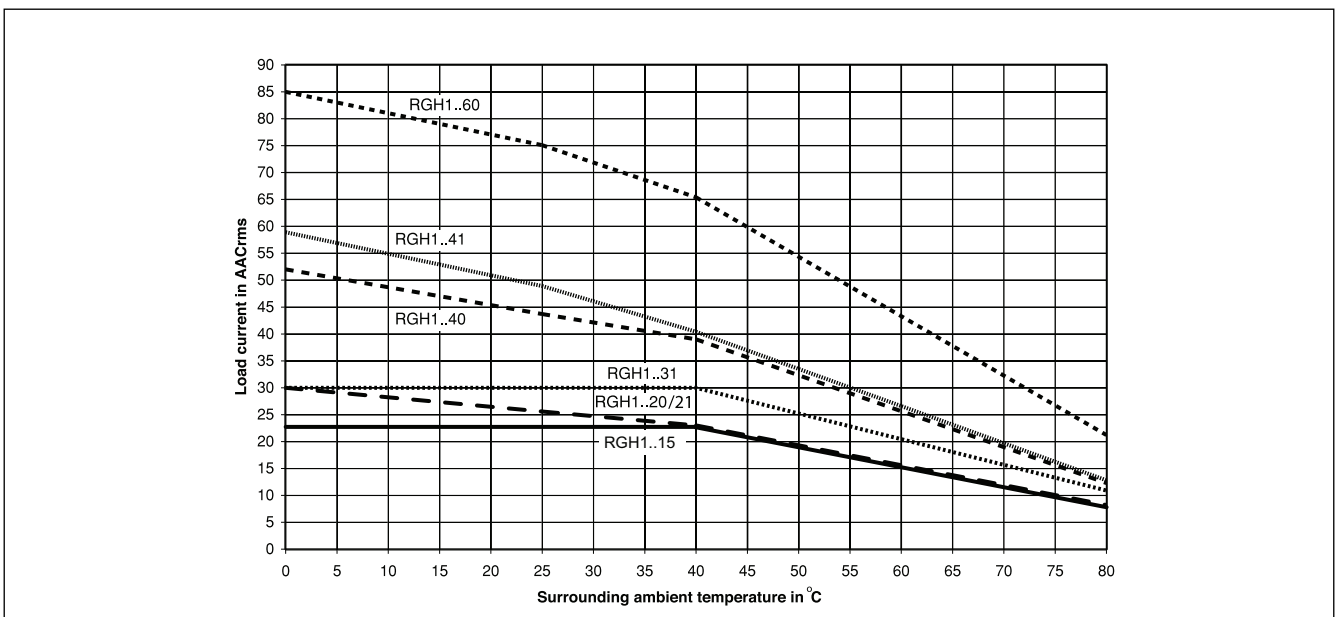

Derating vs. Spacing Curves

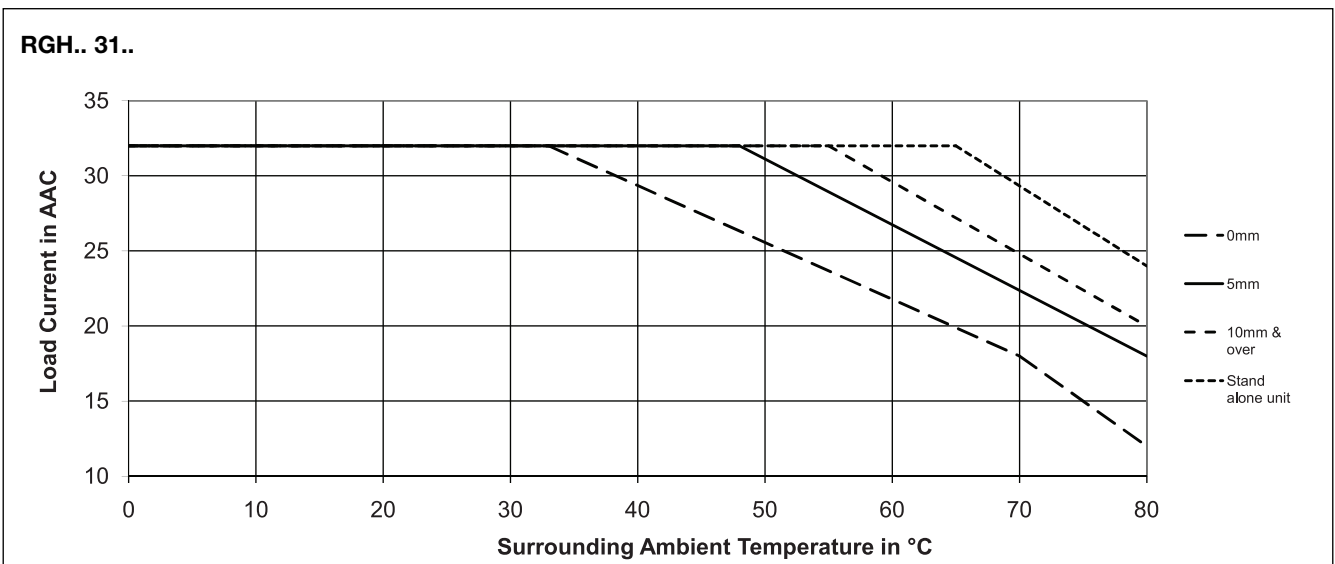
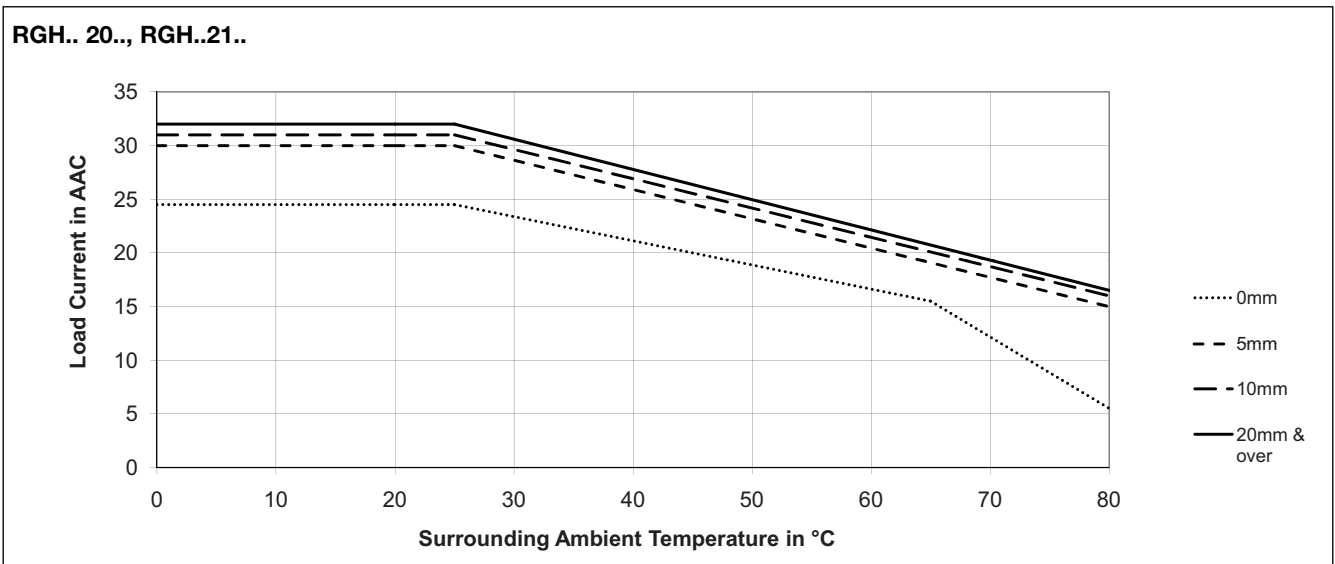
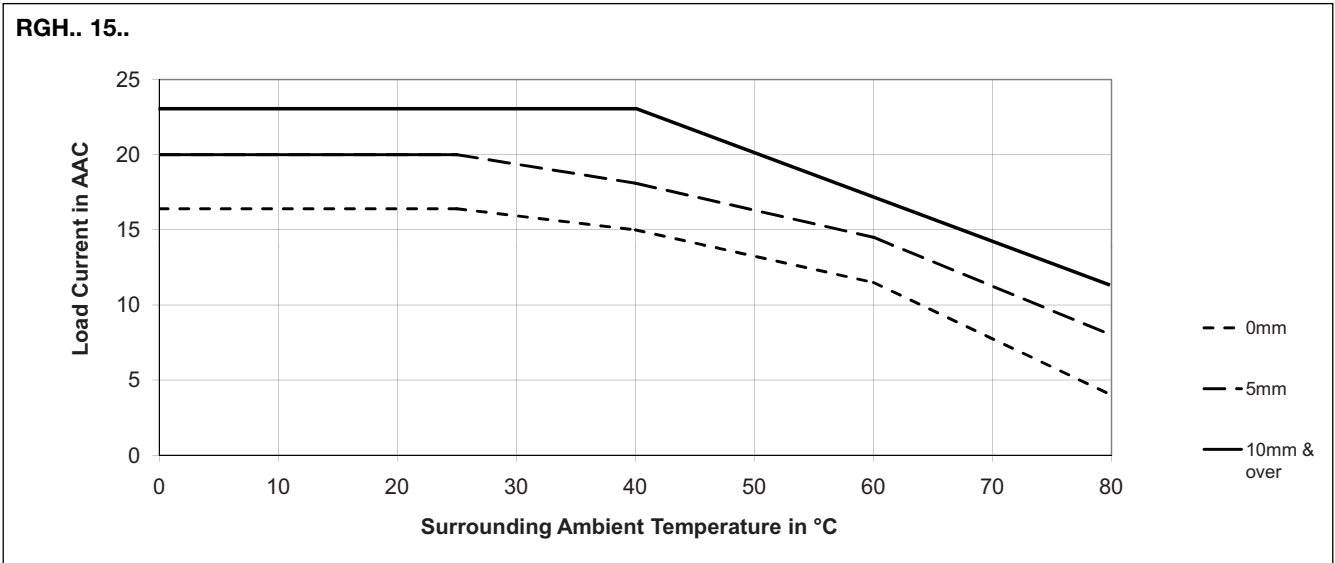

Derating vs. Spacing Curves (cont.)

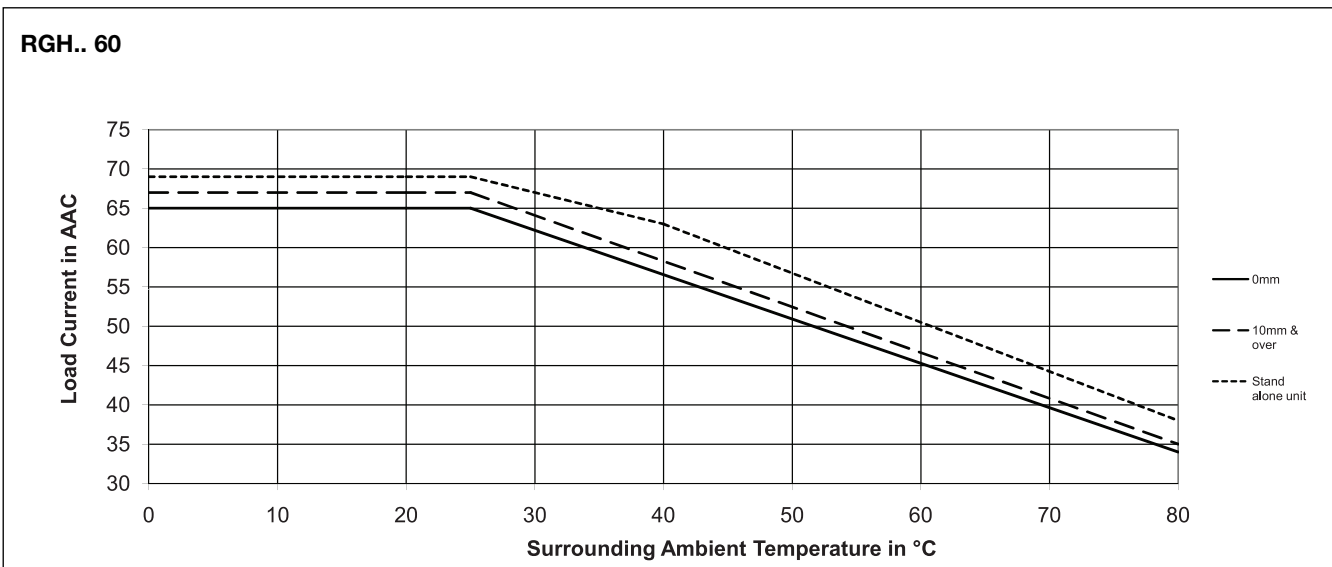
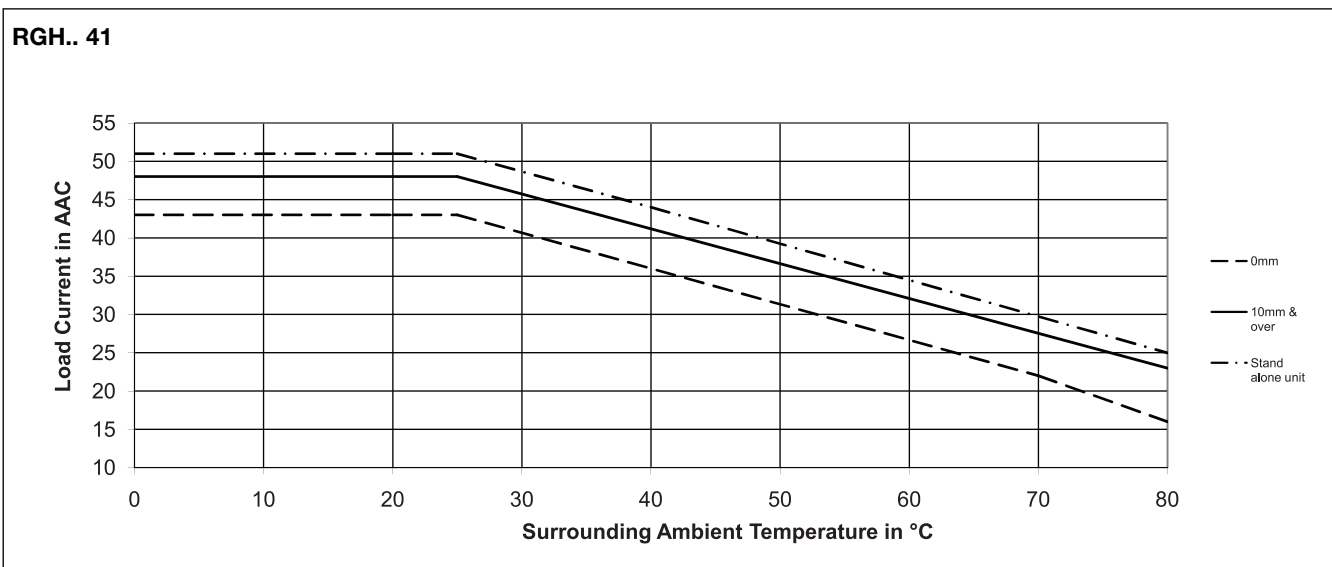
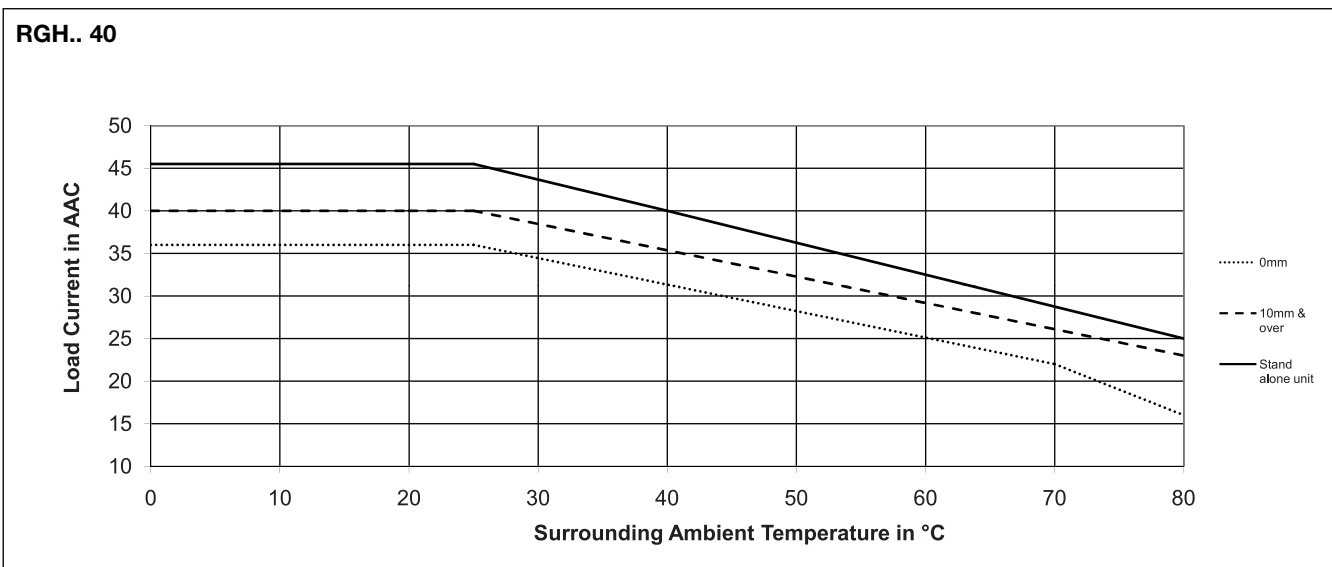

Terminal Layout and Dimensions

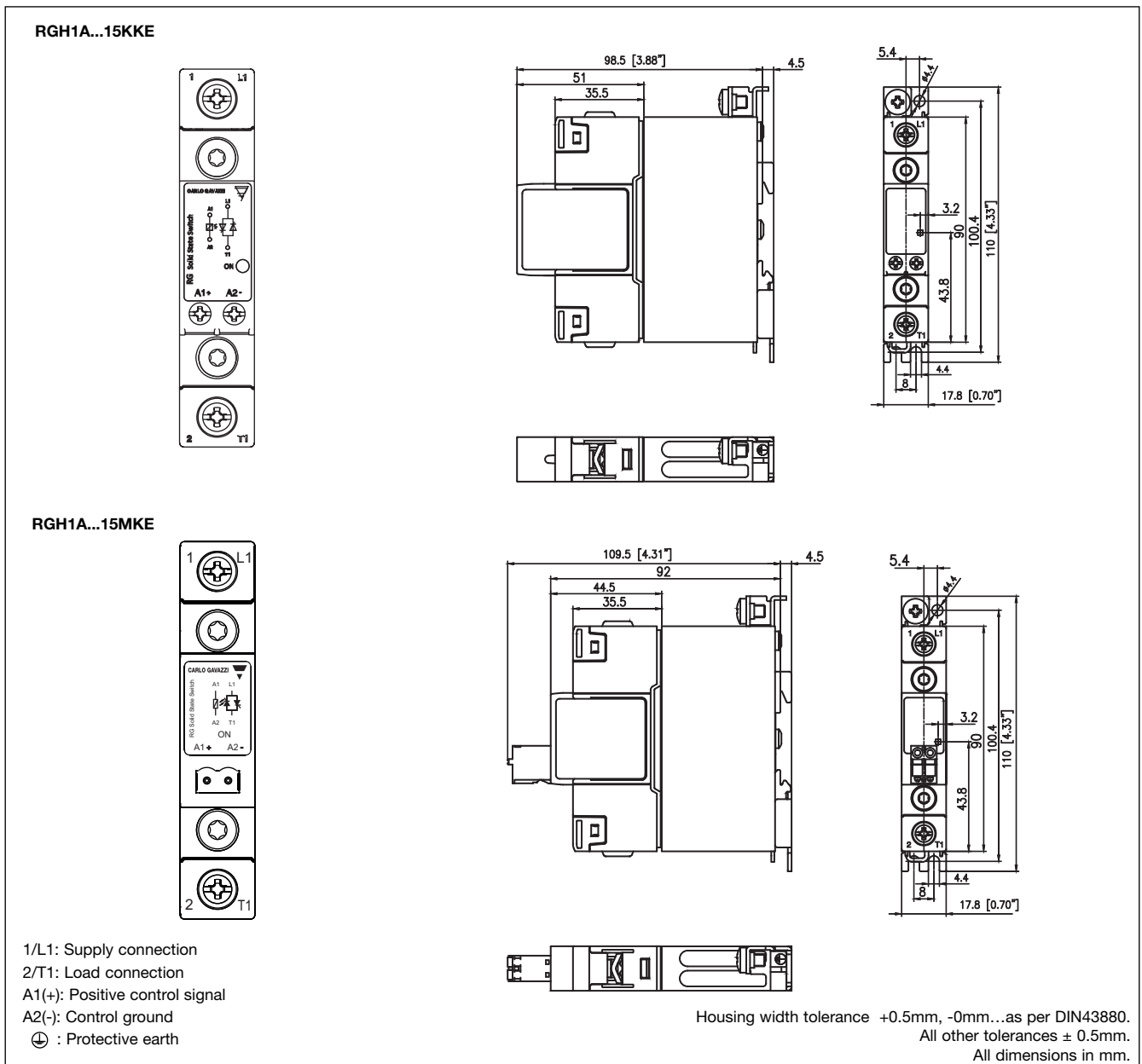

Terminal Layout and Dimensions (cont.)

RGH1A...20KKE, RGH1A...21KKE

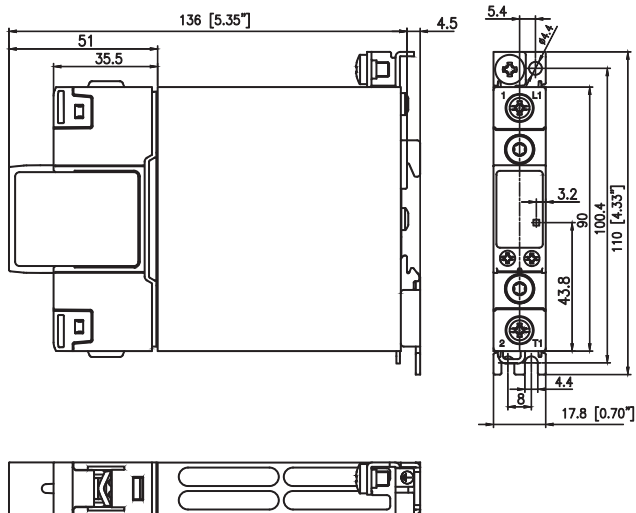
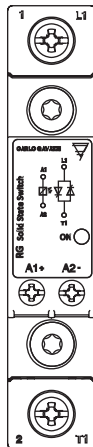

RGH1A...20MKE, RGH1A...21MKE

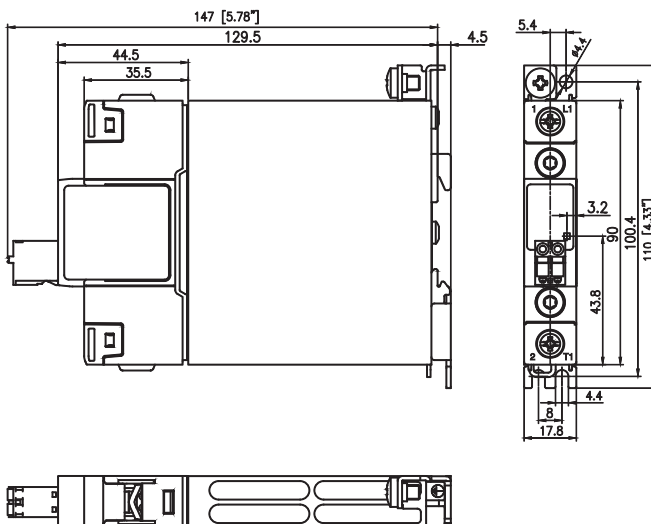
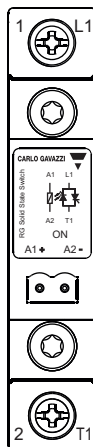

RGH1A...31KKE

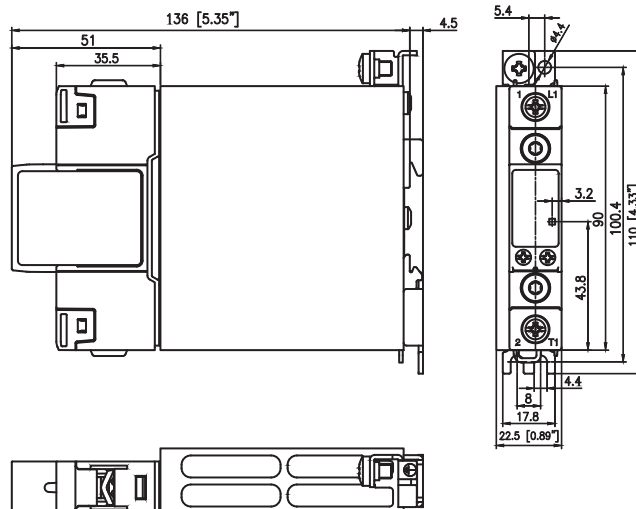
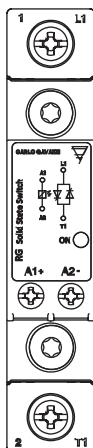

- 1/L1: Supply connection
- 2/T1: Load connection
- A1(+): Positive control signal
- A2(-): Control ground
- ⊕ : Protective earth

Housing width tolerance +0.5mm, -0mm...as per DIN43880.
All other tolerances ± 0.5mm. All dimensions in mm.

Terminal Layout and Dimensions (cont.)

RGH1A...31MKE

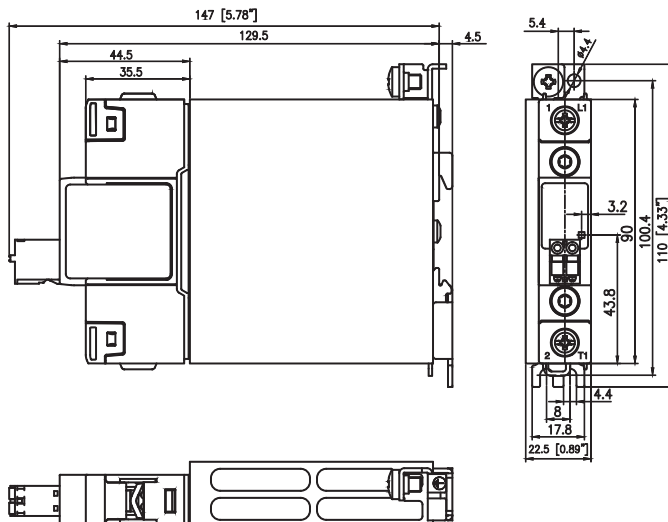
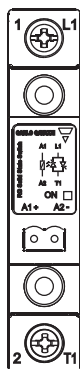

RGH1A...40KGE, RGH1A...41KGE

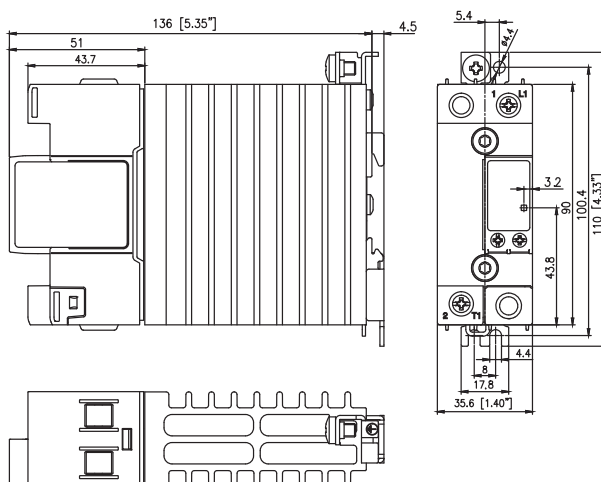
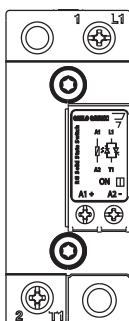

RGH1A...41MGE

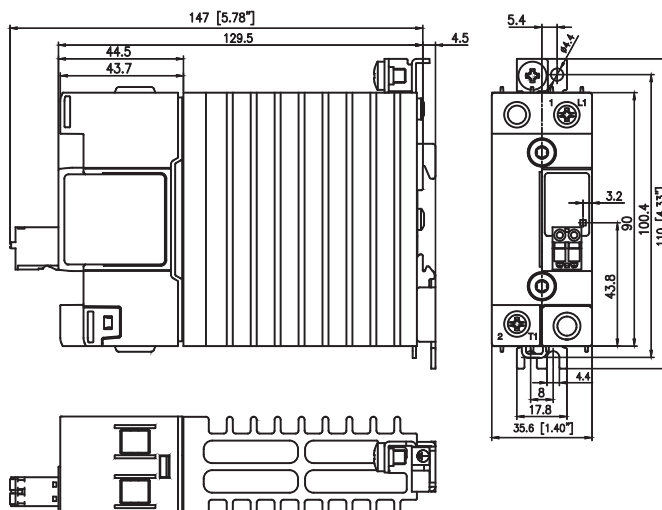
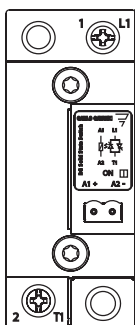

- 1/L1: Supply connection
- 2/T1: Load connection
- A1(+): Positive control signal
- A2(-): Control ground
- ⊕ : Protective earth

Housing width tolerance +0.5mm, -0mm...as per DIN43880.
All other tolerances ± 0.5mm. All dimensions in mm.

Terminal Layout and Dimensions (cont.)

RGH1A...41KGU

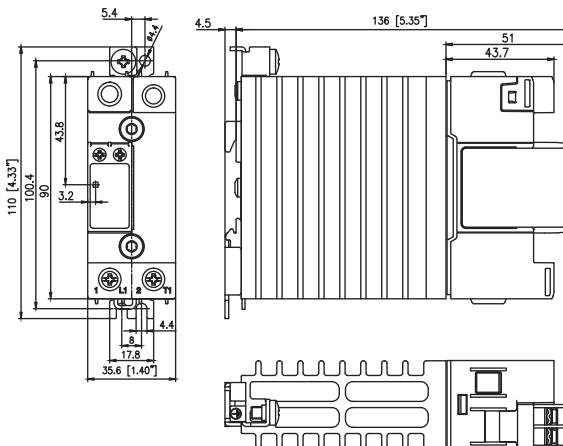
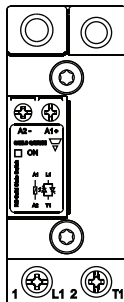

RGH1A...60KGE

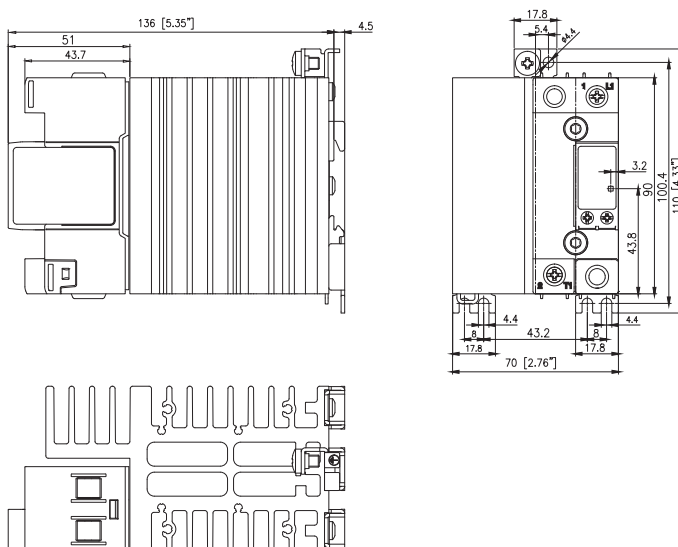
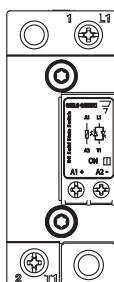

RGH1A...60KGU

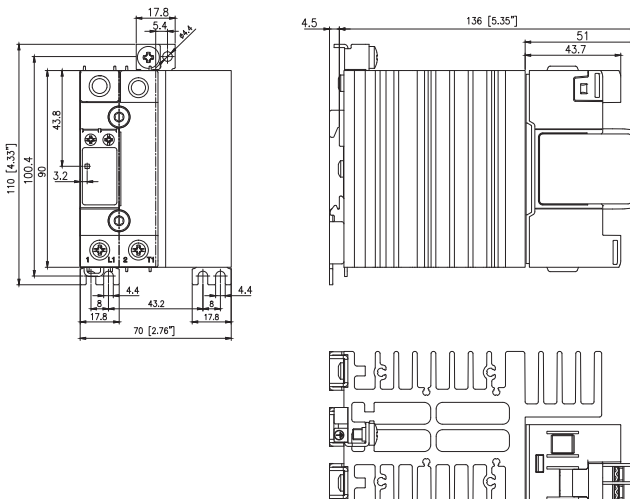
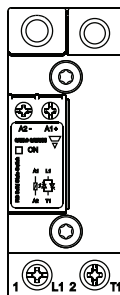

- 1/L1: Supply connection
- 2/T1: Load connection
- A1(+): Positive control signal
- A2(-): Control ground
- ⊕ : Protective earth

Housing width tolerance +0.5mm, -0mm...as per DIN43880.
All other tolerances ± 0.5mm. All dimensions in mm.

Connection Diagram

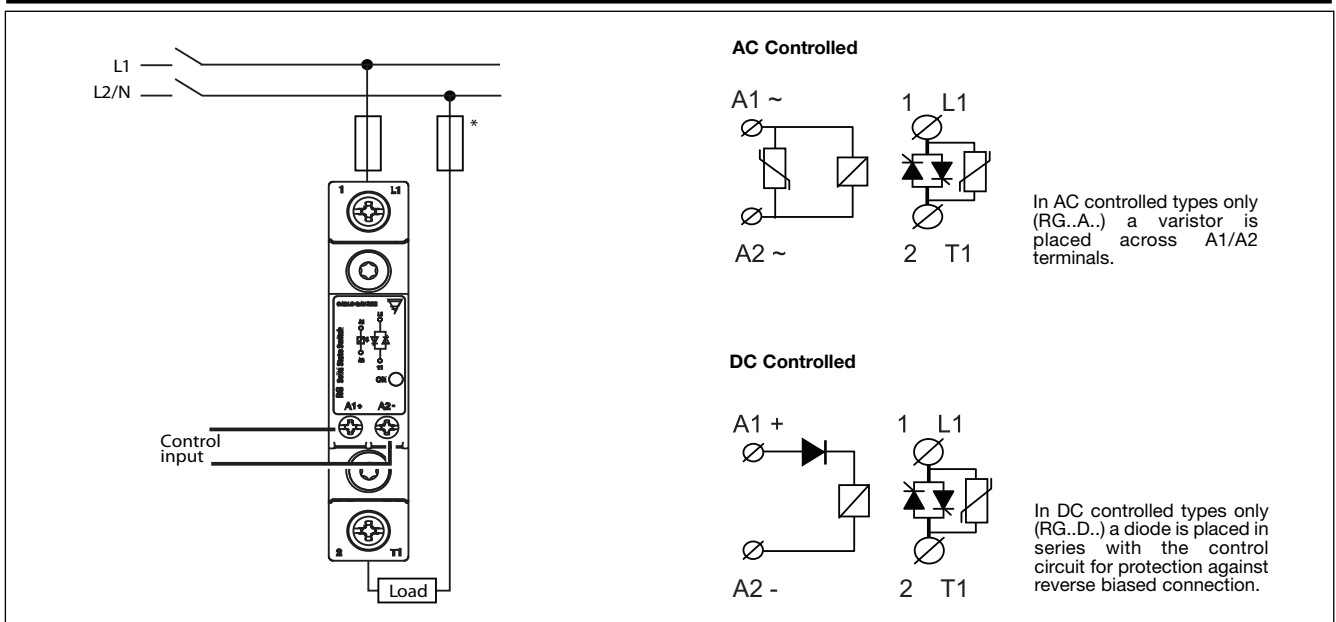

Connection Specifications

POWER CONNECTIONS: 1/L1, 2 /T1

Use 75°C copper (Cu) conductors

CONTROL CONNECTIONS: A1(+), A2(-)

Use 60 / 75°C copper (Cu) conductors

	RG..KKE RG..MKE	RG..KGE ; RG..KGU RG..MGE
Stripping Length (X)	12mm	11mm
Connection type	M4 screw with captivated washer	M5 screw with box clamp

Rigid (Solid & Stranded)
UL/ cUL rated data

	2 x 2.5..6 mm ² 2 x 14.. 10 AWG	1 x 2.5..6 mm ² 1 x 14.. 10 AWG	1 x 2.5..25mm ² 1 x 14.. 3 AWG
--	---	---	--

Flexible with end sleeve

	2 x 1.0...2.5mm ² 2 x 2.5...4mm ² 2 x 18...14AWG 2 x 14...12 AWG	1 x 1.0..4mm ² 1 x 18.. 12 AWG	1 x 2.5..16mm ² 1 x 14.. 6 AWG
--	---	--	--

Flexible without end sleeve

	2 x 1.0...2.5mm ² 2 x 2.5...6mm ² 2 x 18...14AWG 2 x 14...10 AWG	1 x 1.0..6mm ² 1 x 18.. 10 AWG	1 x 4..25mm ² 1 x 12.. 3 AWG
--	---	--	--

Torque specifications

	Pozidriv 2	Pozidriv 2
	UL: 2Nm (17.7lb-in) IEC: 1.5 - 2.0Nm (13.3 - 17.7lb-in)	UL: 2.5Nm (22lb-in) IEC: 2.5 - 3.0Nm (22 - 26.6lb-in)

Aperture for termination lug 12.3mm

Protective Earth (PE) Connection

	M5, 1.5Nm (13.3 in-lb)
--	------------------------

Torque specifications



RG.KKE, RG..KGE, RG..KGU

M3, Pozidriv 1
UL: 0.5Nm (4.4lb-in)
IEC: 0.5 - 0.6Nm (4.4 - 5.3lb-in)

Stripping Length (X)

8mm

Rigid (Solid & Stranded)

UL/ cUL rated data

	2 x 0.5..2.5mm ² 2 x 18..12 AWG	1 x 0.5..2.5mm ² 1 x 18..12 AWG
--	---	---

Flexible with end sleeve

	2 x 0.5..2.5mm ² 2 x 18..12AWG	1 x 0.5..2.5mm ² 1 x 18..12AWG
--	--	--

CONTROL CONNECTIONS: A1(+), A2(-)

Use 60/75°C copper (Cu) conductors

RG..MKE, RG..MGE

Stripping Length (X)

12 - 13mm

Rigid (Stranded)

UL/ cUL rated data

	1 x 0.2...2.5mm ² 1 x 24...12 AWG
--	---

Note: M5 PE screw not provided with SSR. PE connection required when product is intended to be used in Class 1 applications according to EN/IEC 61140.

Installation Instructions

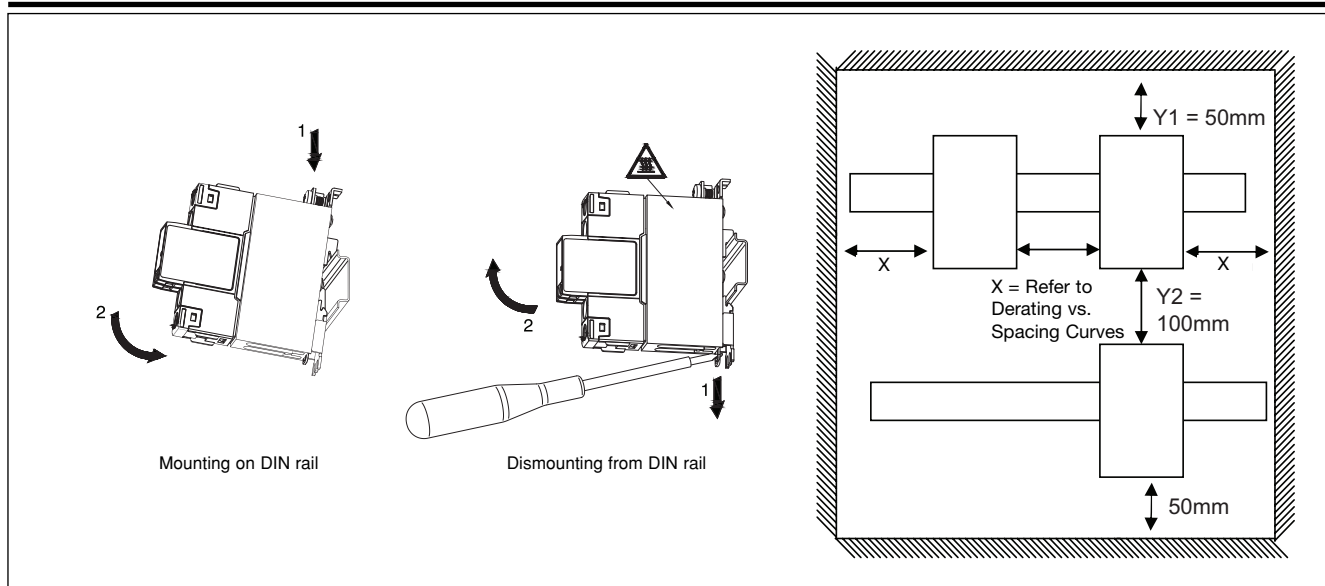

Short Circuit Protection

Protection Co-ordination, Type 1 vs Type 2:

Type 1 protection implies that after a short circuit, the device under test will no longer be in a functioning state. In type 2 co-ordination the device under test will still be functional after the short circuit. In both cases, however the short circuit has to be interrupted. The fuse between enclosure and supply shall not open. The door or cover of the enclosure shall not be blown open. There shall be no damage to conductors or terminals and the conductors shall not separate from terminals. There shall be no breakage or cracking of insulating bases to the extent that the integrity of the mounting of live parts is impaired. Discharge of parts or any risk of fire shall not occur.

The product variants listed in the table hereunder are suitable for use on a circuit capable of delivering not more than 100,000 A rms Symmetrical Amperes, 600 Volts maximum when protected by fuses. Tests at 100,000 A were performed with Class J fuses, fast acting; please refer to the table below for maximum allowed ampere rating of the fuse. Use fuses only.

Tests with class J fuses are representative of class CC fuses.

Co-ordination type 1 (UL508)

Part No.	Max. fuse size [A]	Class	Current [kA]	Voltage [VAC]
RGH..15	30	J or CC	100	Max. 600
RGH..20	30	J or CC	100	Max. 600
RGH..21	30	J or CC	100	Max. 600
RGH..31	30	J or CC	100	Max. 600
RGH..40	30	J or CC	100	Max. 600
RGH..41	40	J	100	Max. 600
RGH..60	40	J	100	Max. 600

Co-ordination type 2 (IEC EN 60947-4-2/ -4-3)

Part No.	Ferraz Shawmut		Siba		Current [kA]	Voltage [VAC]
	Max fuse size [A]	Part number	Max fuse size [A]	Part number		
RGH..15	100	A70QS100-4	100	50 194 20.100	100	Max. 600
RGH..20	50	A70QS50-4	-	-	100	Max. 600
RGH..21	100	A70QS100-4	100	50 194 20.100	100	Max. 600
RGH..31	100	A70QS100-4	100	50 194 20.100	100	Max. 600
RGH..40	50	A70QS50-4	-	-	100	Max. 600
RGH..41	100	A70QS100-4	100	50 194 20.100	100	Max. 600
RGH..60	100	A70QS100-4	100	50 194 20.100	100	Max. 600

Type 2 Protection with Miniature Circuit Breakers (M.C.B.s.)

Solid State Relay type	ABB Model no. for Z - type M. C. B. (rated current)	ABB Model no. for B - type M. C. B. (rated current)	Wire cross sectional area [mm ²]	Minimum length of Cu wire conductor [m] ³	
RGH..20, RGH..40	1 pole S201 - Z10 (10A)	S201-B4 (4A)	1.0	7.6	
			1.5	11.4	
			2.5	19.0	
	S201 - Z16 (16A)	S201-B6 (6A)	1.0	5.2	
			1.5	7.8	
			2.5	13.0	
			4.0	20.8	
	S201 - Z20 (20A)	S201-B10 (10A)	1.5	12.6	
			2.5	21.0	
	S201 - Z25 (25A)	S201-B13 (13A)	2.5	25.0	
			4.0	40.0	
	RGH..15 RGH..21 RGH..31 RGH..41 RGH..60	2 pole S202 - Z25 (25A)	S202-B13 (13A)	2.5	19.0
				4.0	30.4
		1 pole S201 - Z20 (20A)	S201-B10 (10A)	1.5	4.2
2.5				7.0	
4.0				11.2	
S201 - Z32 (32A)		S201-B16 (16A)	2.5	13.0	
			4.0	20.8	
			6.0	31.2	
2 pole S202 - Z20 (20A)		S202-B10 (10A)	1.5	1.8	
			2.5	3.0	
			4.0	4.8	
S201 - Z32 (32A)		S201-B16 (16A)	2.5	13.0	
			4.0	20.8	
			6.0	31.2	
S202 - Z32 (32A)	S202-B16 (16A)	2.5	5.0		
		4.0	8.0		
		6.0	12.0		
		10.0	20.0		
S202 - Z50 (50A)	S202-B25 (25A)	4.0	14.8		
		6.0	22.2		
		10.0	37.0		

3. between MCB and Load (including return path which goes back to the mains).

Note: A prospective current of 6kA and a 230/400V power supply system is assumed for the above suggested specifications. For cables with different cross section than those mentioned above please consult Carlo Gavazzi's Technical Support Group.

Accessories

Control Plugs



Ordering Key

Pack of 10 spring
loaded control plugs

RGM25

* Refer to 'Connection Specifications' section for further details.