

Solid State Relays SOLITRON MINI - With Integrated Heatsink Types RJ1A, RJ1B



- AC semiconductor contactor
- Zero switching (RJ1A) or instant-on switching (RJ1B)¹
- Direct copper bonding (DCB) technology
- LED-indication
- Self-lifting terminals
- 2 input ranges: 4-32 VDC and 24-275 VAC/24-48VDC
- Operational ratings up to 30 AACrms and 600 VAC
- Blocking voltage: Up to 1200 V_p
- Opto-isolation > 4000 VACrms
- Over-temperature safety option²

Product Description

The SOLITRON Mini is a single-phase Solid State Contactor designed to replace electro-mechanical contactors in industrial heating and motor applications, especially when switching is frequent. The product is ready to mount on DIN-rail or chassis and comes with integral heatsink. The standard housing dimensions enable installation in limited space and the terminal layout allows both contactor (E) and SSR (U) type connection. Two

2.5mm² cables can be connected in each screw terminal to allow looping. A removable IP20 cover allows connection of a 4mm² cable with crimped terminal. An LED indicates the status of the control input. The superior heat-transfer efficiency combined with a robust power management system make this a high reliability product that can meet the most stringent functional requirements.

Ordering Key

RJ 1 A 60 D 30 E P

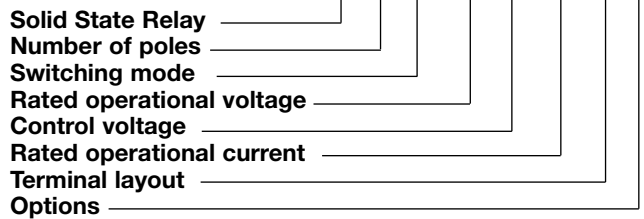

Type Selection

Switching mode	Rated operational voltage	Control voltage	Rated operational current	Terminal Layout	Options
A: Zero switching B: Instant-on switching ¹	23: 230 VACrms 60: 600 VACrms	D: 4-32 VDC A: 24-275 VAC/ 24-48 VDC	20: 20 AACrms 30: 30 AACrms	U: SSR E: Contactor	P: Over-temp. protection ² V: Integrated varistor

Selection Guide

Rated operational voltage	Blocking voltage	Control voltage	Rated operational current		
			20 A	30 A	30A+OTP ²
230 VACrms	650 V _p	4 - 32 VDC	RJ1A23D20E RJ1A23D20U	RJ1A23D30E RJ1A23D30U	RJ1A23D30EP
		24 - 275 VAC / 24 - 48VDC	RJ1A23A20E RJ1A23A20U	RJ1A23A30E RJ1A23A30U	RJ1A23A30EP
600 VACrms	1200 V _p	4 - 32 VDC	RJ1A60D20E RJ1A60D20U	RJ1A60D30E RJ1A60D30U	RJ1A60D30EP
		24 - 275 VAC / 24 - 48VDC	RJ1A60A20E RJ1A60A20U	RJ1A60A30E RJ1A60A30U	RJ1A60A30EP

Notes

- 1 RJ1B..: For instant-on version replace RJ1A with RJ1B. Example: RJ1B23D30E. Not available with OTP and not available with AC control voltage
- 2 "P" suffix: Over-temperature protection (OTP), available on 30A rated devices with type "E" terminals only

General Specifications

	RJ1.23..	RJ1.60..
Operational voltage range	24 to 265 VAC	42 to 660 VAC
Blocking voltage	650 V _p	1200 V _p
Operational frequency range	45 to 65 Hz	45 to 65 Hz
Power factor	≥ 0.5 @ 230 VACrms	≥ 0.5 @ 600 VACrms
Integrated Varistor (RJ1.....V)	275V	680V
Vibration	6g (According to EN50155)	6g (According to EN50155)
Approvals	UL, cUL, CSA	UL, cUL, CSA
CE-marking	Yes	Yes
Pollution degree	2	2

Input Specifications

	RJ1A..D	RJ1B.D	RJ..A
Control voltage range	4 to 32 VDC	4.5 to 32 VDC	24-275VAC/ 24-48 VDC
Pick-up voltage	3.8 VDC	4.25 VDC	22 VAC/DC
Reverse voltage	32 VDC	32 VDC	n/a
Drop-out voltage	1.2 VDC	1.0 VDC	6 VAC/DC
Max input current	12 mA	15 mA	17 mA
Response time pick-up	1/2 cycle	1 ms	1 cycle
Response time drop-out	1/2 cycle	1 cycle	1 cycle

Output Specifications

	RJ..20	RJ..30
Rated operational current AC51 @TA=25°C AC53a @Ta=25°C	20 AACrms 5 AACrms	30 AACrms 15 AACrms
Min. operational current	350 mAACrms	250mAACrms
Rep. overload current t = 1s	< 35 AACrms	<125 AACrms
Non rep. surge current Tj(init.) = 25°C and t = 10 ms	300 A _p	600 A _p
Off-state leakage current @ rated voltage and frequency	< 3 mArms	< 3 mArms
I ² t for fusing t = 10 ms	450 A ² s	1800 A ² s
On-state voltage drop @ rated current	1.6 Vrms	1.6 Vrms
Critical dV/dt off-state	500 V/μs	500 V/μs

Thermal Specifications

	RJ...D	RJ...A
Operating temperature	-30 to +70°C (-22 to +158°F)	-30 to +70°C (-22 to +158°F)
Storage temperature	-40 to +100°C (-40 to +176°F)	-40 to +100°C (-40 to +176°F)

Derating vs. Spacing Curves

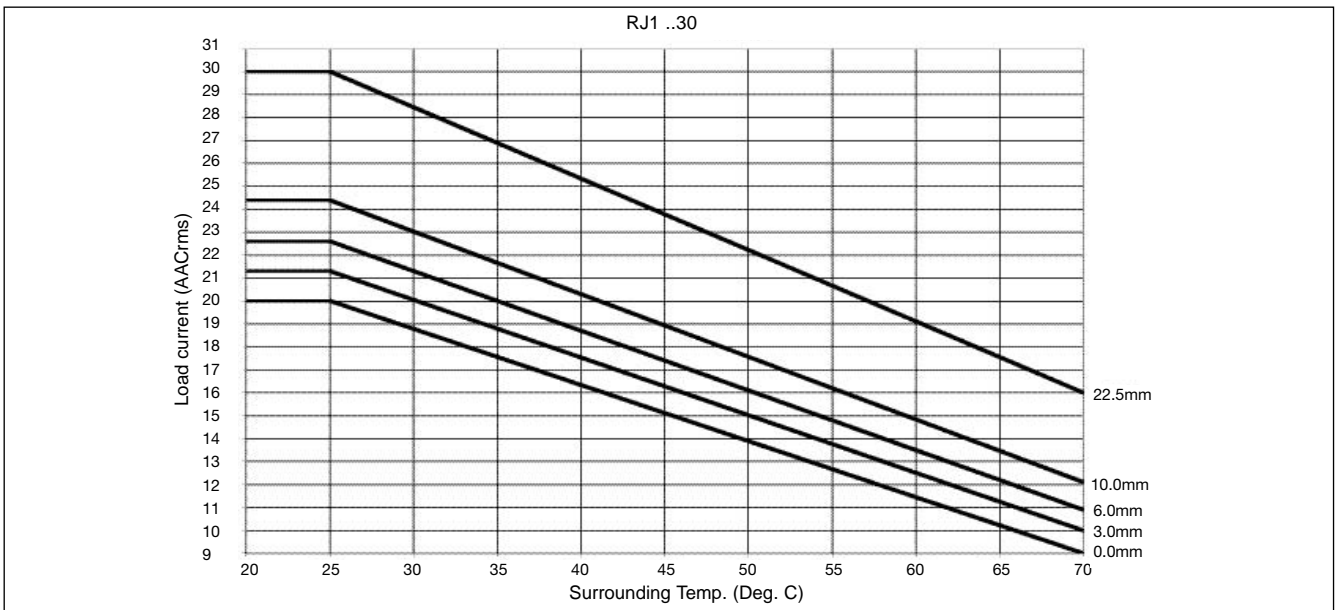
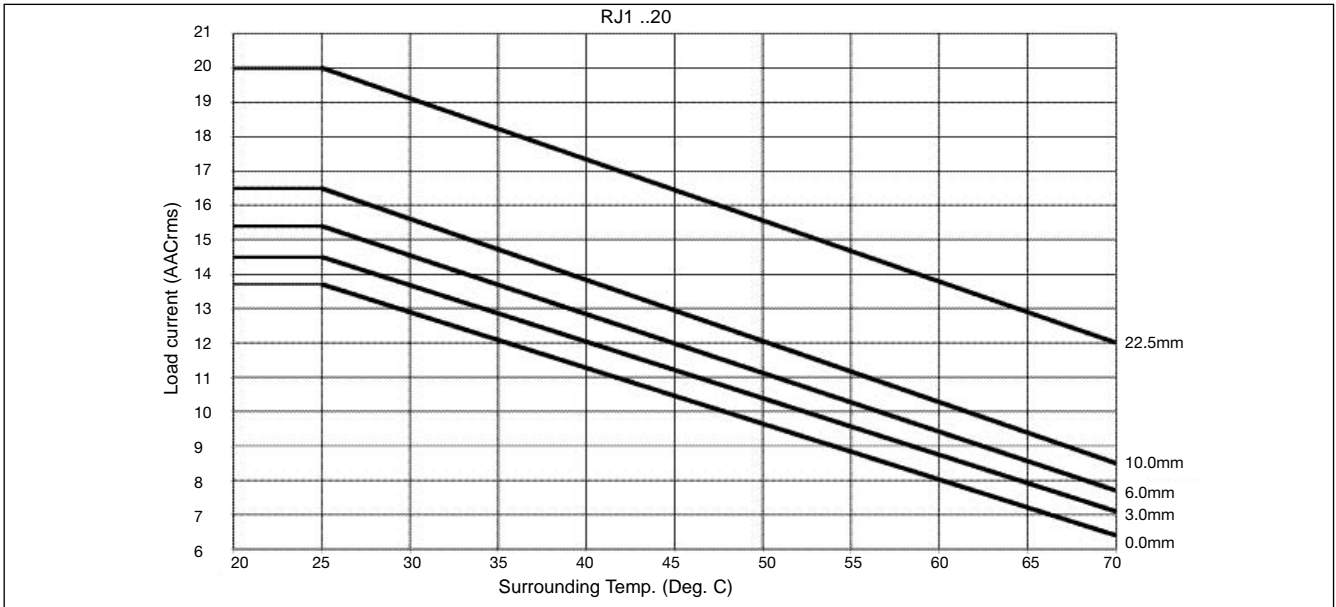

Connection Example

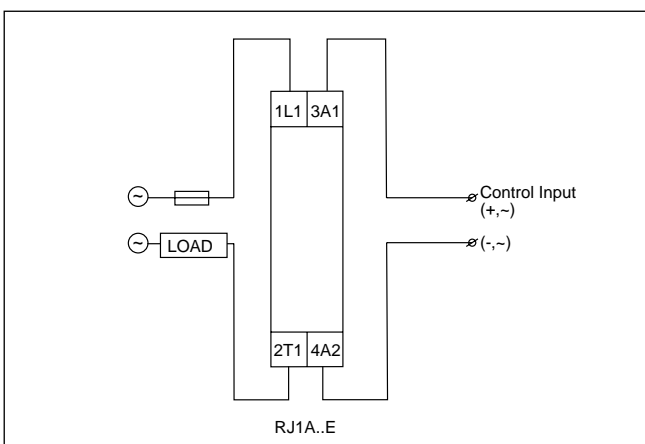

Installation

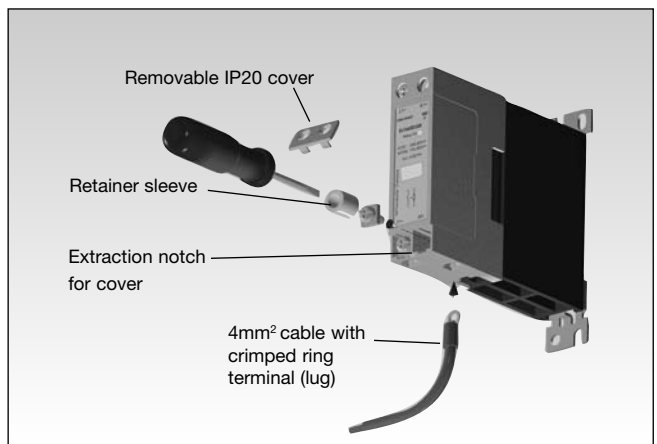

Derating Curve

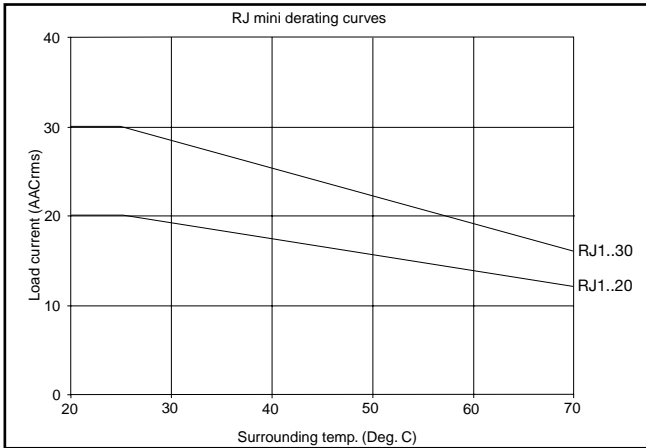

Dissipation Curve

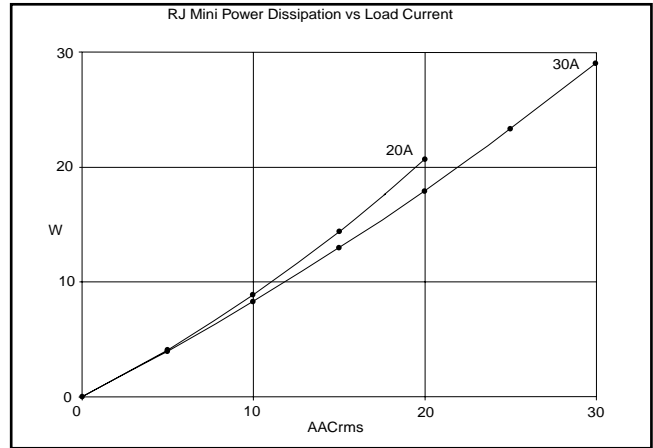

Panel Mounting

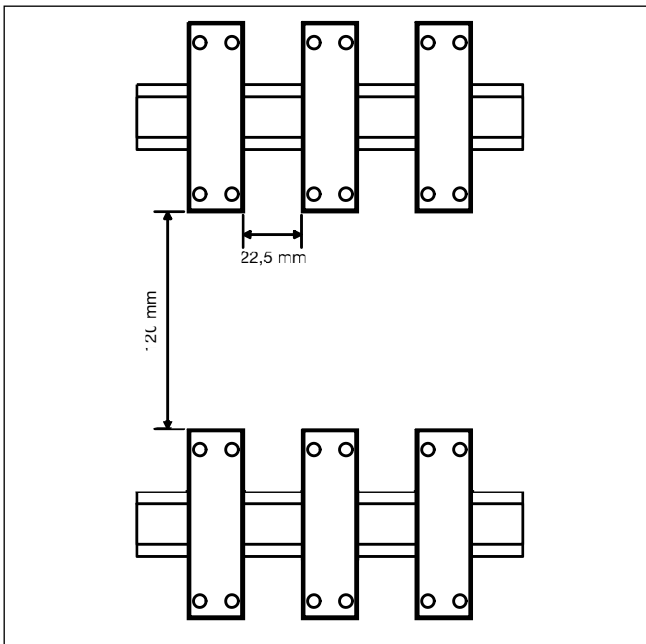

Housing Specifications

Weight	Approx. 225 g
Housing material	PBT Flame retardant
Control terminal cable size	
Min	1 x 0.5 mm ² (1 x AWG20)
Max	2 x 2.5 mm ² (2 x AWG14)
Mounting torque max.	2 Nm
Control terminal screws	M4
Power terminal cable size	
Min	1 x 0.5 mm ² (1 x AWG20)
Max	2 x 2.5 mm ² (2 x AWG14) or
Max (with crimped terminal)	1 x 4 mm ² (1 x AWG 12)
Mounting torque max.	2 Nm
Power terminal screws	M4

Isolation

Rated isolation voltage	
Input to output	≥ 4000 VACrms
Output to case	≥ 4000 VACrms