

SKM 400GB066D

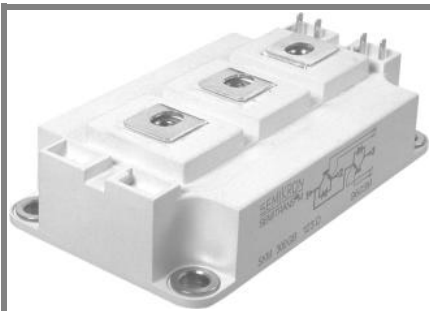

SEMITRANS® 3

Trench IGBT Modules

SKM 400GB066D

Preliminary Data

Features

- Trench = Trenchgate technology
- $V_{CE(sat)}$ with positive temperature coefficient
- High short circuit capability, self limiting to $6 \times I_C$

Typical Applications

- AC inverter drives
- UPS
- Electronic welders

Remarks

- Case temperature limited to $T_C = 125^\circ\text{C}$ max, recommended $T_{op} = -40 \dots +150^\circ\text{C}$
- Product reliability results are valid for $T_j \leq 150^\circ\text{C}$
- Short circuit data: $t_p \leq 6\mu\text{s}$; $V_{GE} \leq 15\text{V}$; $T_j = 150^\circ\text{C}$; $V_{CC} \leq 360\text{V}$, use of soft R_G necessary !
- Take care of over-voltage caused by stray inductances

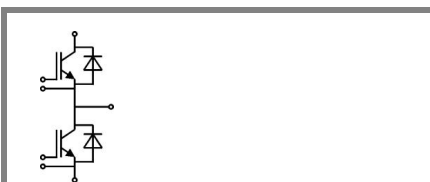

GB

Absolute Maximum Ratings		$T_{case} = 25^\circ\text{C}$, unless otherwise specified		
Symbol	Conditions	Values	Units	
IGBT				
V_{CES}	$T_j = 25^\circ\text{C}$	600	V	
I_C	$T_j = 175^\circ\text{C}$	$T_c = 25^\circ\text{C}$	500	A
		$T_c = 80^\circ\text{C}$	380	A
I_{CRM}	$I_{CRM} = 2 \times I_{Cnom}$	800	A	
V_{GES}		± 20	V	
t_{psc}	$V_{CC} = 360\text{V}$; $V_{GE} \leq 15\text{V}$; $T_j = 150^\circ\text{C}$ $V_{CES} < 600\text{V}$	6	μs	
Inverse Diode				
I_F	$T_j = 175^\circ\text{C}$	$T_c = 25^\circ\text{C}$	450	A
		$T_c = 80^\circ\text{C}$	320	A
I_{FRM}	$I_{FRM} = 2 \times I_{Fnom}$	800	A	
Module				
$I_{t(RMS)}$		500	A	
T_{vj}		-40 ... +175	$^\circ\text{C}$	
T_{stg}		-40 ... +125	$^\circ\text{C}$	
V_{isol}	AC, 1 min.	4000	V	

Characteristics		$T_{case} = 25^\circ\text{C}$, unless otherwise specified			
Symbol	Conditions	min.	typ.	max.	Units
IGBT					
$V_{GE(th)}$	$V_{GE} = V_{CE}$, $I_C = 6,4\text{mA}$	5	5,8	6,5	V
I_{CES}	$V_{GE} = 0\text{V}$, $V_{CE} = V_{CES}$		0,25	0,75	mA
V_{CE0}		$T_j = 25^\circ\text{C}$	0,9	1	V
		$T_j = 150^\circ\text{C}$	0,85	0,9	V
r_{CE}	$V_{GE} = 15\text{V}$	$T_j = 25^\circ\text{C}$	1,4	2,3	$\text{m}\Omega$
		$T_j = 150^\circ\text{C}$	2,1	3	$\text{m}\Omega$
$V_{CE(sat)}$	$I_{Cnom} = 400\text{A}$, $V_{GE} = 15\text{V}$	$T_j = 25^\circ\text{C}_{chiplev.}$	1,45	1,9	V
		$T_j = 150^\circ\text{C}_{chiplev.}$	1,7	2,1	V
C_{ies}	$V_{CE} = 25$, $V_{GE} = 0\text{V}$	$f = 1\text{MHz}$	24,7		nF
C_{oes}			1,54		nF
C_{res}			0,73		nF
Q_G	$V_{GE} = -8\text{V} \dots +15\text{V}$		3000		nC
R_{Gint}	$T_j = ^\circ\text{C}$		2		Ω
$t_{d(on)}$	$R_{Gon} = 1,5\Omega$	$V_{CC} = 300\text{V}$ $I_C = 400\text{A}$	200		ns
t_r			60		ns
E_{on}	$R_{Goff} = 1,5\Omega$	$T_j = 150^\circ\text{C}$ $V_{GE} = -8\text{V}/+15\text{V}$	8		mJ
$t_{d(off)}$			560		ns
t_f			53		ns
E_{off}			16		mJ
$R_{th(j-c)}$	per IGBT			0,12	K/W

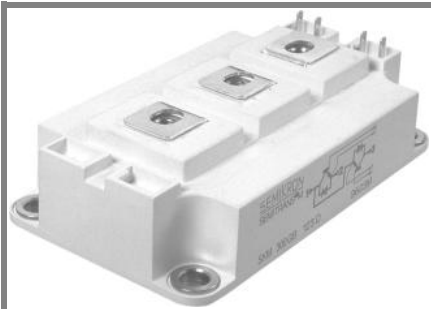

SEMITRANS® 3

Trench IGBT Modules

SKM 400GB066D

Preliminary Data

Features

- Trench = Trenchgate technology
- $V_{CE(sat)}$ with positive temperature coefficient
- High short circuit capability, self limiting to $6 \times I_C$

Typical Applications

- AC inverter drives
- UPS
- Electronic welders

Remarks

- Case temperature limited to $T_C = 125^\circ\text{C}$ max, recommended $T_{op} = -40 \dots +150^\circ\text{C}$
- Product reliability results are valid for $T_j \leq 150^\circ\text{C}$
- Short circuit data: $t_p \leq 6\mu\text{s}$; $V_{GE} \leq 15\text{V}$; $T_j = 150^\circ\text{C}$; $V_{CC} \leq 360\text{V}$, use of soft R_G necessary !
- Take care of over-voltage caused by stray inductances



GB

Characteristics

Symbol	Conditions	min.	typ.	max.	Units
Inverse Diode					
$V_F = V_{EC}$	$I_{Fnom} = 400\text{ A}$; $V_{GE} = 0\text{ V}$ $T_j = 25^\circ\text{C}_{chiplev.}$		1,4	1,6	V
V_{F0}	$T_j = 25^\circ\text{C}$		0,95	1	V
r_F	$T_j = 25^\circ\text{C}$		1,1	1,5	mΩ
I_{RRM}	$I_F = 400\text{ A}$ $T_j = 150^\circ\text{C}$		410		A
Q_{rr}	$di/dt = 7250\text{ A}/\mu\text{s}$		62		μC
E_{rr}	$V_{GE} = -8\text{ V}$; $V_{CC} = 300\text{ V}$		14		mJ
$R_{th(j-c)D}$	per diode			0,2	K/W
Module					
L_{CE}			15	20	nH
R_{CC+EE}	res., terminal-chip $T_{case} = 25^\circ\text{C}$		0,35		mΩ
	$T_{case} = 125^\circ\text{C}$		0,5		mΩ
$R_{th(c-s)}$	per module			0,038	K/W
M_s	to heat sink M6	3		5	Nm
M_t	to terminals M6	2,5		5	Nm
w				325	g

This is an electrostatic discharge sensitive device (ESDS), international standard IEC 60747-1, Chapter IX.

This technical information specifies semiconductor devices but promises no characteristics. No warranty or guarantee expressed or implied is made regarding delivery, performance or suitability.

SKM 400GB066D

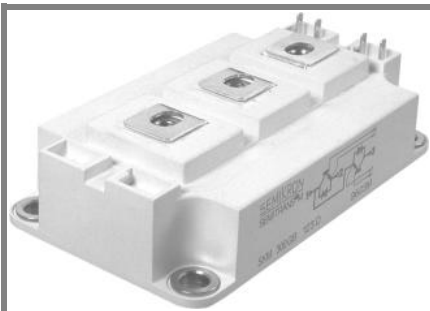

SEMITRANS® 3

Trench IGBT Modules

SKM 400GB066D

Preliminary Data

Features

- Trench = Trenchgate technology
- $V_{CE(sat)}$ with positive temperature coefficient
- High short circuit capability, self limiting to $6 \times I_C$

Typical Applications

- AC inverter drives
- UPS
- Electronic welders

Remarks

- Case temperature limited to $T_C = 125^\circ\text{C}$ max, recommended $T_{op} = -40 \dots +150^\circ\text{C}$
- Product reliability results are valid for $T_j \leq 150^\circ\text{C}$
- Short circuit data: $t_p \leq 6\mu\text{s}$; $V_{GE} \leq 15\text{V}$; $T_j = 150^\circ\text{C}$; $V_{cc} \leq 360\text{V}$, use of soft R_G necessary !
- Take care of over-voltage caused by stray inductances

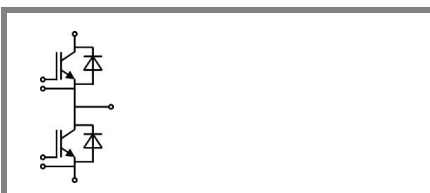

GB

Z_{th}		Values	Units
Symbol	Conditions		
$Z_{th(j-c)I}$			
$R_{\theta j-c}$	$i = 1$	80	mk/W
$R_{\theta j-c}$	$i = 2$	22,5	mk/W
$R_{\theta j-c}$	$i = 3$	6,4	mk/W
$R_{\theta j-c}$	$i = 4$	1,1	mk/W
$\tau_{th j-c}$	$i = 1$	0,0447	s
$\tau_{th j-c}$	$i = 2$	0,0223	s
$\tau_{th j-c}$	$i = 3$	0,0015	s
$\tau_{th j-c}$	$i = 4$	0,0002	s
$Z_{th(j-c)D}$			
$R_{\theta j-c}$	$i = 1$	130	mk/W
$R_{\theta j-c}$	$i = 2$	55	mk/W
$R_{\theta j-c}$	$i = 3$	12,5	mk/W
$R_{\theta j-c}$	$i = 4$	2,5	mk/W
$\tau_{th j-c}$	$i = 1$	0,054	s
$\tau_{th j-c}$	$i = 2$	0,01	s
$\tau_{th j-c}$	$i = 3$	0,0015	s
$\tau_{th j-c}$	$i = 4$	0,1	s

SKM 400GB066D

UL recognized, file no. E 63 532

CASED56

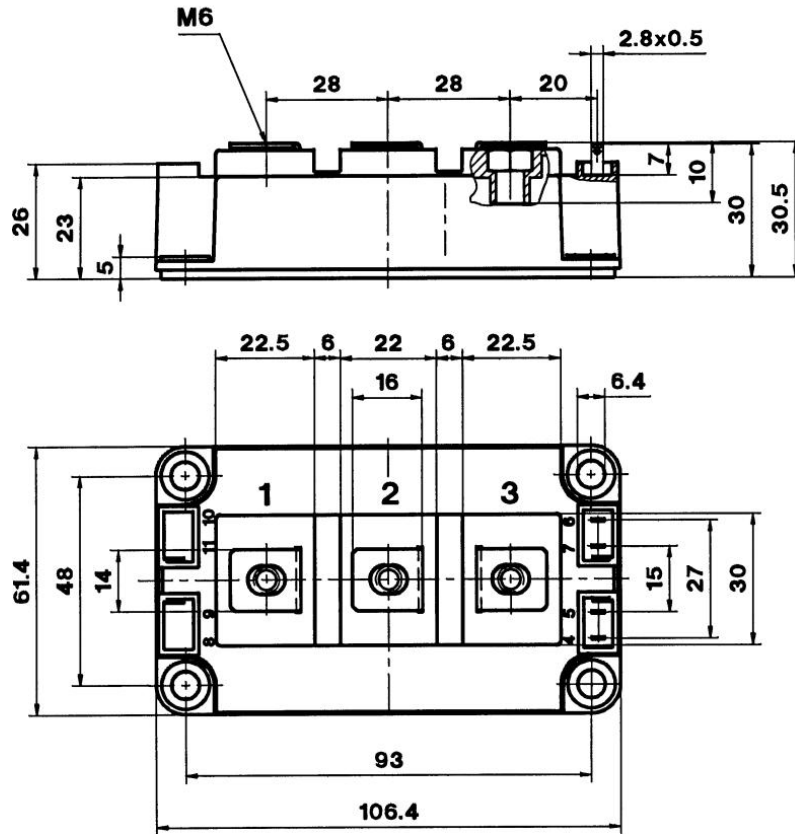

Case D 56

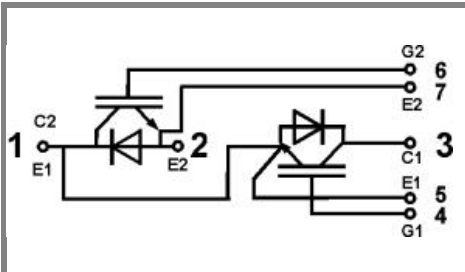

GB

Case D56