

the sensor people

## DB 12 B

### Double Sheet Testing Unit



en 04-2014/06 50126538  
We reserve the right to  
make technical changes

© 2014

Leuze electronic GmbH + Co. KG

In der Braike 1

D-73277 Owen / Germany

Phone: +49 7021 573-0

Fax: +49 7021 573-199

<http://www.leuze.com>

[info@leuze.de](mailto:info@leuze.de)

<b>1</b>	<b>General information .....</b>	<b>2</b>
1.1	Explanation of symbols .....	2
1.2	Declaration of conformity .....	2
<b>2</b>	<b>Safety notices .....</b>	<b>3</b>
2.1	Safety standards .....	3
2.2	Intended use .....	3
2.3	Areas of application .....	3
2.4	Organisational measures .....	3
<b>3</b>	<b>Device overview .....</b>	<b>4</b>
<b>4</b>	<b>Specifications .....</b>	<b>6</b>
<b>5</b>	<b>Mounting the transmitter and receiver.....</b>	<b>8</b>
<b>6</b>	<b>Electrical connection .....</b>	<b>9</b>
<b>7</b>	<b>Commissioning .....</b>	<b>10</b>
<b>8</b>	<b>Operation - inputs and outputs.....</b>	<b>14</b>
<b>9</b>	<b>Diagnosis in the case of error .....</b>	<b>15</b>
<b>10</b>	<b>Application-specific extension types.....</b>	<b>16</b>
10.1	VDB 12 B/6.10P - Detection of splices on blister material .....	16
10.2	VDB 12 B/6.11N - Automatic teach on first sheet .....	16
10.3	VDB 12B/6.12P - without teach button in the cover .....	16

## 1 General information

### 1.1 Explanation of symbols

The symbols used in this technical description are explained below.



**Attention!**

*This symbol appears before text passages which must absolutely be observed. Failure to heed this information can lead to injuries to personnel or damage to the equipment.*



**Notice!**

*This symbol indicates text passages containing important information.*

### 1.2 Declaration of conformity

The DB 12 B double sheet testing unit sensor system has been developed and manufactured in adherence with the applicable European standards and directives.



**Notice!**

*The corresponding declaration of conformity can be requested from the manufacturer.*

The manufacturer of the product, Leuze electronic GmbH + Co. KG in D-73277 Owen/Teck, possesses a certified quality assurance system in accordance with ISO 9001.



For UL applications:  
only for use in "Class 2" circuits according to NEC.

## 2 Safety notices

### 2.1 Safety standards

The DB 12 B double sheet testing unit has been developed subject to the applicable safety standard EN 60947-5-2 (IEC 60947-5-2).

### 2.2 Intended use

The DB 12 B double sheet testing unit has been conceived as a monitoring device mainly for paper working machines. It monitors incoming paper sheets at machines designed to process single sheets. It is used to detect and signal double sheets in the sheet feeder during operation.



#### **Attention!**

***The DB 12 B is not a safety module acc. to EU machine guidelines.***

*The protection of machine and the device cannot be guaranteed if the device is operated in a manner not corresponding to its intended use.*

*Access to or changes on the device, except where expressly described in this manual, are not authorised.*

### 2.3 Areas of application

Double sheets made of the following materials can be reliably detected by the DB 12 B:

- Paper
- Plastic
- Metal foils

For paper, the measurement range is 20g/m<sup>2</sup> (airmail paper) to 1200g/m<sup>2</sup> (homogeneous cardboard).

### 2.4 Organisational measures

All entries in this operating manual must be heeded, in particular those in the section "Safety notices" and "Commissioning".

Keep this technical description in a safe place. It should be accessible at all times.

#### **Safety regulations**

Observe the locally applicable safety regulations.

#### **Qualified personnel**

Mounting, commissioning and maintenance of the device may only be carried out by qualified personnel.

### 3 Device overview

The ultrasonic double sheet testing system consists of a VDB 12 B... analysis amplifier and a pair of DB 18 UP ultrasonic sensors.

It detects and checks primarily paper, plastic and metal foils which are guided in by feeders. The device functions as a presence monitor by constantly applying a signal at the **single sheet** output when an object is located between the sensors. It functions as a double sheet testing unit by comparing each sheet with the stored reference value. A detected double sheet is signalled at the **double sheet** output.

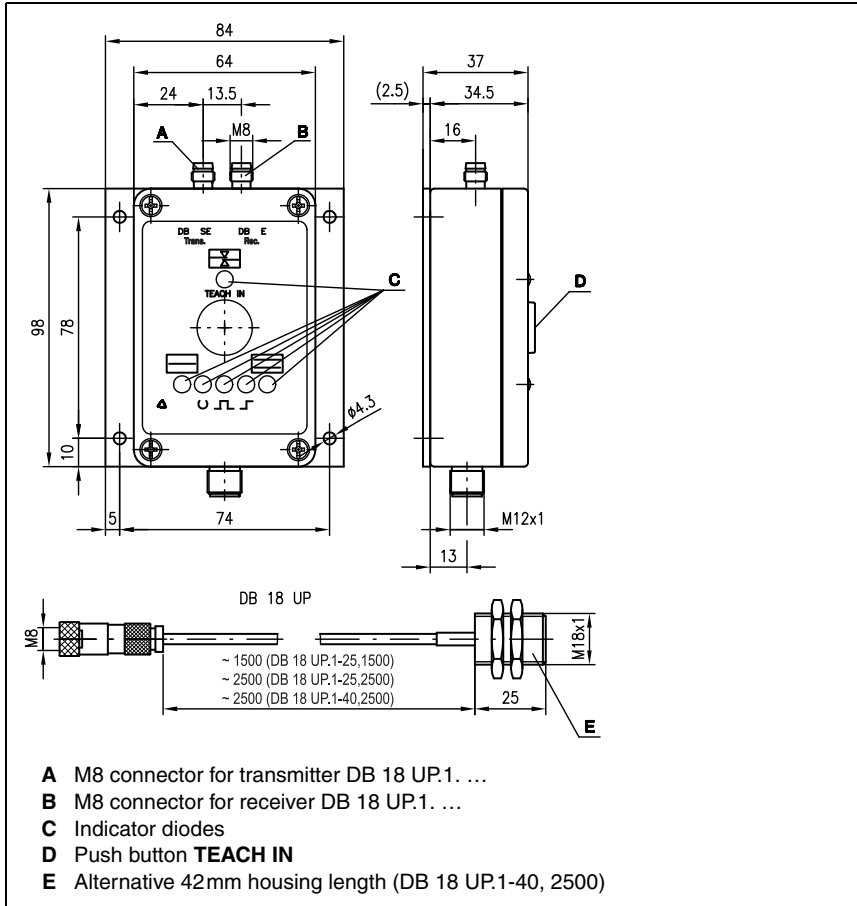

Figure 3.1: Device overview - dimensions

**Controls and indicators**

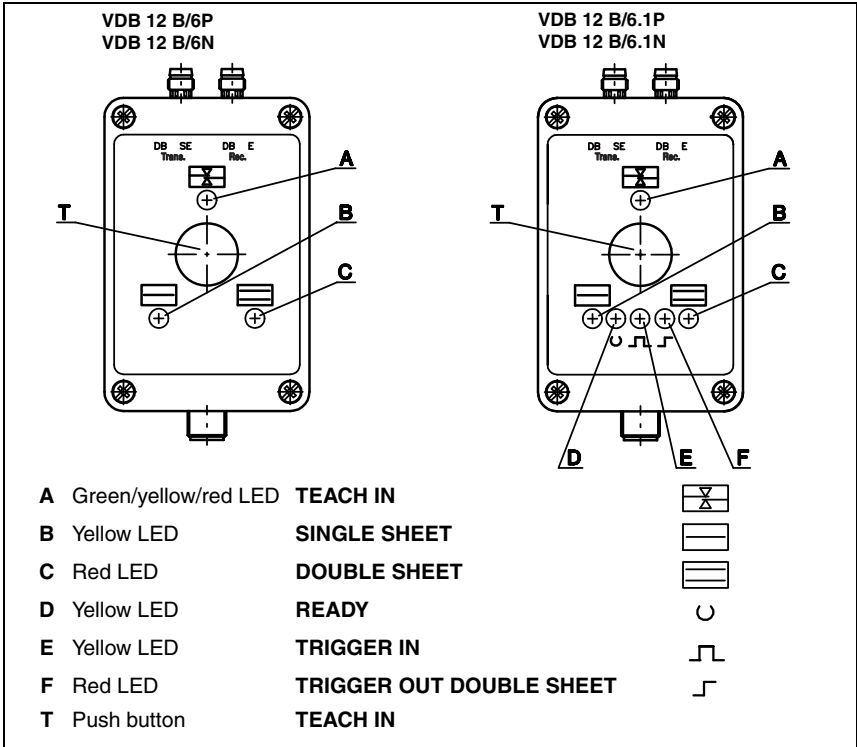

Figure 3.2: Controls and indicators

**Order guide**

**Designation**

- Sensor pair M18 x 25mm, cable length 1.5m
- Sensor pair M18 x 25mm, cable length 2.5m
- Sensor pair M18 x 42mm, cable length 2.5m
- Amplifier (positive logic)
- Amplifier (negative logic)
- Amplifier with TRIGGER input (positive logic)
- Amplifier with TRIGGER input (negative logic)

**Model**

- DB 18 UP.1-25,1500
- DB 18 UP.1-25,2500
- DB 18 UP.1-40,2500
- VDB 12 B/6P
- VDB 12 B/6N
- VDB 12 B/6.1P
- VDB 12 B/6.1N

**Part No.**

- 501 09014
- 501 08998
- 501 08997
- 501 04021
- 501 04402
- 501 04038
- 501 04403

**Accessories**

**Designation**

- Cable 5m, PVC, 5-pin, with M12 connectors
- Cable 5m, PUR, 8-pin, with M12 connectors

**Model**

- K-D M12A-5P-5m-PVC
- K-D M12A-8P-5m-PUR

**Part No.**

- 501 04557
- 501 04590

## 4 Specifications

### Technical data for sensor DB 18 UP

#### Sensor data

Operating range	20 ... 60mm
Converter frequency	200kHz $\pm 2\%$
Ultrasonic lobe	approx. 12°

#### Mechanical data

Housing	nickel-faced brass
Weight	30g
Connection type	1.5/2.5m cable with M8 connector, 3-pin, bending radius $r > 25\text{mm}$

### Technical data for analysis amplifier VDB 12 B/...

#### Timing

Switching frequency	200Hz
Input pulse	min. 5ms
Delay before start-up	$\leq 300\text{ms}$

#### Electrical data

Operating voltage $U_B$ <sup>1)</sup>	18 ... 30VDC (incl. residual ripple)
Residual ripple	$\leq 15\%$ of $U_B$
Open-circuit current	$\leq 75\text{mA}$
Switching output	2 push-pull switching outputs <sup>2)</sup>
Function	4 push-pull switching outputs <sup>1)</sup> single sheet detected, or $\geq 1$ sheet double sheet detected, or $\geq 2$ sheets double sheet triggered <sup>3)</sup> double sheet testing unit ready to operate <sup>4)</sup>
Signal voltage high/low	$\geq (U_B - 2V) / \leq 2V$
Output current	max. 100mA per output
TEACH/TRIGGER input	$R_{in} = 10\text{k}\Omega$
TEACH/TRIGGER IN active/not active <sup>5)</sup>	.../...P (PNP): $\geq 10V / \leq 2V$ or not connected .../...N (NPN): $\leq 2V / \geq 10V$ or not connected
TRIGGER IN pulse duration	$\geq 1\text{ms}$
TEACH-/TRIGGER IN duration	max. 100ms
TEACH IN delay <sup>6)</sup>	approx. 300ms

#### Indicators

##### all models:

LED green A	double sheet testing unit ready
LED A yellow	teach-in process
LED A red flashing	error (see chapter 9)
LED yellow B	single sheet detected
LED red C	double sheet detected
<b>only .../6.1...:</b>	
LED yellow D	ready for function READY
LED yellow E	inquiry signal TRIGGER IN
LED red F	double sheet triggered TRIGGER OUT

#### Mechanical data

Housing	aluminium, black powder-coated
Weight	400g
Connection type	M12 connector, .../6...: 5-pin .../6.1...: 8-pin



**Environmental data**

Ambient temp. (operation/storage)	0°C ... +50°C / -40°C ... +70°C
Protective circuit <sup>7)</sup>	1,2,3
VDE safety class	III
Protection class	IP 65
Standards applied	EN 60947-5-2
Certifications	UL 508, C22.2 No.14-13 <sup>1) 8)</sup>

- 1) For UL applications: only for use in "Class 2" circuits according to NEC.
- 2) Function: .../...P = active high (+24V); inactive low (0V),  
.../...N = active low (0V); inactive high (+24V).  
The push-pull switching outputs must not be connected in parallel
- 3) Is set during low/high transition (.../...P) or high/low transition (.../...N) of the TRIGGER IN input and reset when the measurement field becomes vacant; trigger delay  $\leq 1$  ms, i.e., response time from edge until switching of the switching output is  $\leq 1$  ms
- 4) Is set when the operating voltage is applied if the receiving level is adequate as well as after the teach event if the calibration was successful.
- 5) Setting the Teach IN input disables the TEACH IN button (see page 10)
- 6) Only applies for automatic calibration during sheet movement (automatic teach)
- 7) 1=transient protection, 2=polarity reversal protection, 3=short circuit protection
- 8) These proximity switches shall be used with UL Listed Cable assemblies rated 30V, 0.5A min, in the field installation, or equivalent (categories: CYJV/CYJV7 or PVVA/PVVA7)

## 5 Mounting the transmitter and receiver

The transmitter and receiver (DB 18 UP) are identical in construction and are to be mounted according to the table in figure 5.1 at an angle which varies depending on the sheet material. A larger angle of inclination increases the flutter range; e.g. with a 35° pitch, flutter is permissible within 50% of the measurement field. The distance between transmitter and receiver must be at least 20mm and can be max. 60mm.

Ensure that alignment is exact ( $\pm 1^\circ$ ). If the alignment does not run along the axis, the working range is reduced.



**Notice!**

When aligning the transmitter and receiver, take care to ensure the most exact alignment possible. See "Alignment mode" on page 10. To ensure proper function, the sensors must be inclined by the angle "B" towards the vertical.

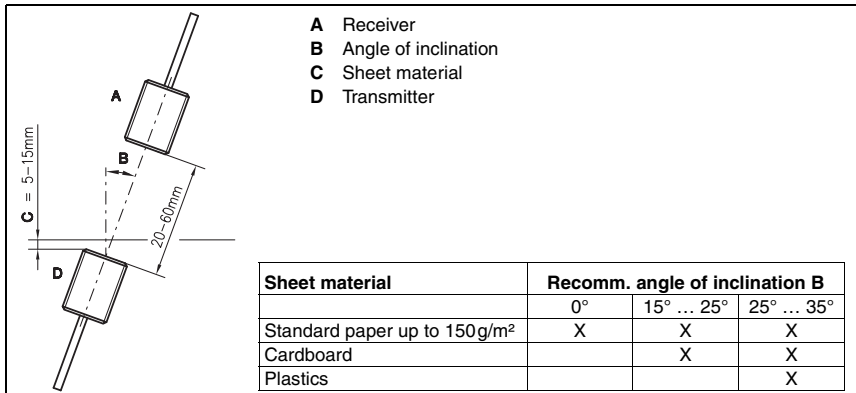

Figure 5.1: Mounting the transmitter and receiver

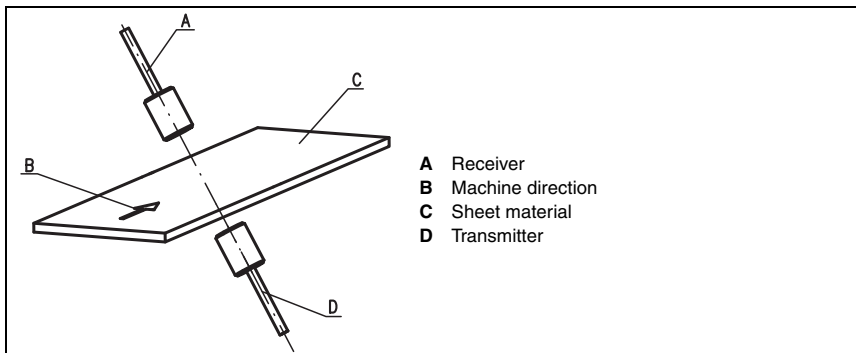

Figure 5.2: Recommended configuration for maximum functionality

## 6 Electrical connection

Connect the transmitter and receiver at the appropriate M8 connectors of the VDB 12 B... analysis amplifier.

Connect the analysis amplifier acc. to connection diagram (figure 6.1).

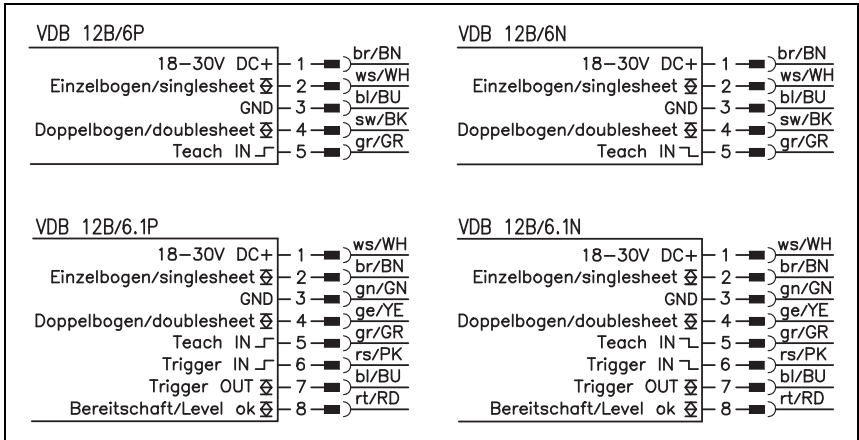

Figure 6.1: Connection diagrams VDB 12 B...

### Circuit logic

**VDB 12B/...P -> positive logic**

**VDB 12B/...N -> negative logic**

## 7 Commissioning



**Notice!**

If the indicators flash during the initial commissioning, a calibration must first be performed on a single sheet.

First apply operating voltage. An **alignment mode** is available for commissioning. This can be used to check the alignment of the transmitter and receiver.

**Alignment mode**

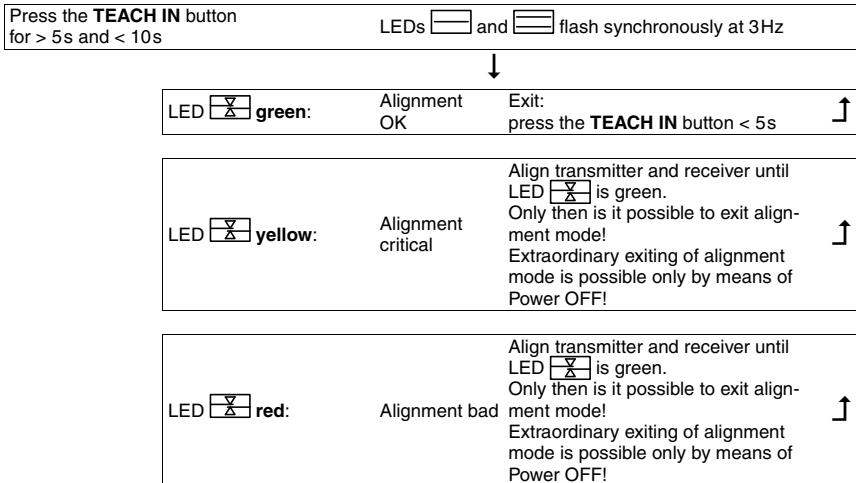

**Notice!**

After exiting alignment mode, it is **absolutely necessary to perform a calibration**.

**Calibrating on the material to be detected**

For reliable detection of double layers of the medium being processed, it is always necessary to perform a calibration on a single sheet of the medium.



Calibration of the material to be detected can be performed by either pressing the **TEACH IN** button on the analysis amplifier for 0.3s to 5s or by means of a control command at the **Teach IN** input (pin 5).





**Notice!**

Setting the **Teach IN** input (pin 5) disables the **TEACH IN** button. As soon as a signal is applied once via the **Teach IN** input for the purpose of calibration, the **TEACH IN** button remains inactive (disabled) until the next Power On.

During the calibration process, LED  illuminates yellow.

If the calibration was successful, LED  illuminates green and LEDs  and  yellow. The **single sheet** and **ready** outputs are activated. The reference value remains stored until the next calibration process.

If the calibration process was not successful, LED  flashes red and LEDs  and  illuminate red. The **double sheet** and **TRIGGER OUT** outputs (double sheet triggered) are activated.



### **Notice!**

*Causes of unsuccessful calibration include e.g.:*

- *More than 1 sheet between the sensors.*
- *Unsuitable sheet material, e.g. due to lamination or coating, too thin, too thick, or air pockets present.*
- *Pitch to sensors too low.*

For devices VDB 12 B/6.1N and VDB 12 B/6.1P with trigger input **Trigger IN** (pin 6), it is recommended that the device be configured in such a way that, for Trigger IN, the threshold signals be adapted so that the amplifier always operates in the optimum range (1., standard mode). This mode is especially recommended when the material consistency changes during operation (moisture, density, ...).

The VDB 12 B analysis amplifier can be operated in 3 different operating modes (teach modes):

1. **Standard mode:**

Teach with intelligent transmitter/receiver control for covering a wide spectrum of materials. Automatic signal adaptation (averaging) during operation for VDB 12 B/6.1....

2. **Automatic teach:**

300ms after sheet detection by the ultrasonic sensors, teach-in occurs automatically. In this operating mode, manual or external teaching is not necessary. Automatic signal adaptation (averaging) possible during operation for VDB 12 B/6.1.... Another automatic teach-in is carried out when the ultrasonic path is clear for more than 2s.

3. **Fixed switching threshold:**

This operating mode is recommended when the process does not permit manual or external teaching. In this operating mode, the variety of materials to be detected is limited.

**Selecting the operating mode (teach mode)**

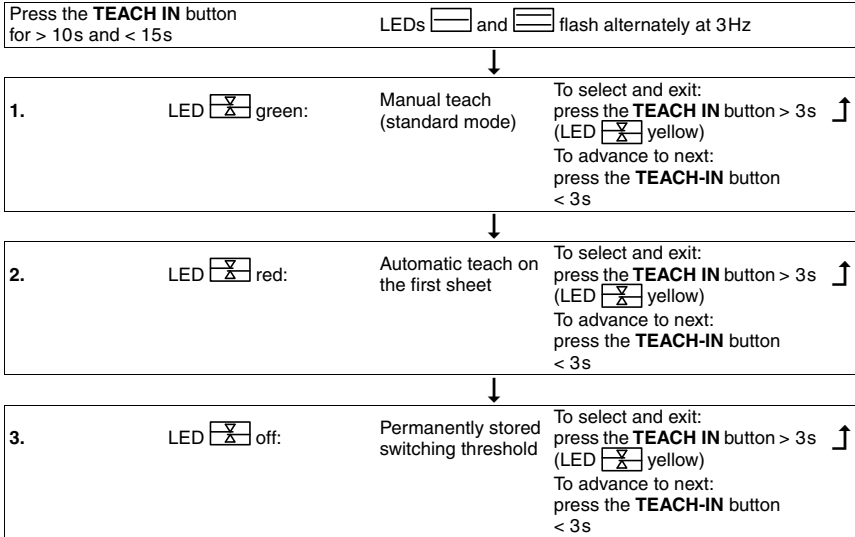

**Attention!**

After selecting the operating mode (teach mode), a calibration must be performed!

**Adapting the averaging calculation (VDB 12 B/6.1... only)**

For device variants VDB 12 B/6.1... with trigger input, it is possible to adapt the signals during running control operation (operating mode 1, **standard mode**).

Signal adaptation is performed by averaging measurement values which are detected at the respective **Trigger IN**. A lower value, e.g. 4, means that an average value is calculated from 4 trigger IN measurement values; a higher value, e.g. 128, means that an average value is calculated from 128 trigger-in measurement values. Signal adaptation occurs every time the set number of trigger pulses is reached.



Signal adaptation (averaging) is also possible in operating mode 2, **automatic teach**.





















**Attention!**

After changing the averaging, recalibration must be performed!

Press the **TEACH IN** button for > 15s and < 20s

LED  flashes red, LED  illuminates yellow. The other LEDs display the current configured average value

Average value via	LED 	LED 	LED 	
off = no signal adaptation	off	off	off	To select and exit: press the <b>TEACH IN</b> button > 3s (LED  briefly green)  To advance to next: press the <b>TEACH-IN</b> button < 3s.
4 values (trigger pulses)	on	off	off	To select and exit: press the <b>TEACH IN</b> button > 3s (LED  briefly green)  To advance to next: press the <b>TEACH-IN</b> button < 3s.
8 values (trigger pulses)	off	on	off	To select and exit: press the <b>TEACH IN</b> button > 3s (LED  briefly green)  To advance to next: press the <b>TEACH-IN</b> button < 3s.
16 values (trigger pulses, default)	on	on	off	To select and exit: press the <b>TEACH IN</b> button > 3s (LED  briefly green)  To advance to next: press the <b>TEACH-IN</b> button < 3s.
32 values (trigger pulses)	off	off	on	To select and exit: press the <b>TEACH IN</b> button > 3s (LED  briefly green)  To advance to next: press the <b>TEACH-IN</b> button < 3s.
64 values (trigger pulses)	on	off	on	To select and exit: press the <b>TEACH IN</b> button > 3s (LED  briefly green)  To advance to next: press the <b>TEACH-IN</b> button < 3s.
128 values (trigger pulses)	off	on	on	To select and exit: press the <b>TEACH IN</b> button > 3s (LED  briefly green)  To advance to next: press the <b>TEACH-IN</b> button < 3s.
No change back	on	on	on	To select and exit: press the <b>TEACH IN</b> button > 3s (LED  briefly green) 



**Attention!**

After changing the averaging, recalibration must be performed!

## 8 Operation - inputs and outputs

The evaluation unit VDB 12 B/6P or VDB 12 B/6N continuously signals the situation occurring between the sensors to two outputs.

The **single sheet output** (pin 2) is activated as long as **one or more sheets** are located in the measurement field.

The **double sheet output** (pin 4) is activated as long as **two or more sheets** are located in the measurement field.



### **Notice!**

*For reliable operation, it is essential that calibration be performed on the material to be detected. See "Calibrating on the material to be detected" on page 10.*

Also available on the VDB 12 B/6.1... evaluation units are a **Trigger IN query input**, a **Trigger OUT double sheet output** stored at the query time, as well as a **ready output**.

If a double sheet is detected on the ascending edge (VDB 12 B/6.1P) or on the falling edge (VDB 12 B/6.1N) of the query, the **Trigger OUT** output is set. This remains set until the ultrasonic path is cleared.

The **ready** output is set if the receiving level is sufficient when operating voltage is supplied. It remains set until the next calibration, provided a calibration has already been successfully completed.

The reference value remains stored even after a voltage interruption.







## 9 Diagnosis in the case of error



**Attention!**

In the event of an error, the **ready** output is not active and LED  is switched off!

The device LEDs indicate the following error states:

LED 	LED 	LED 	LED 	LED 	Meaning	Cause	Remedy
red flashing (6 Hz)	yellow flashing (6 Hz)				Double-sheet control not calibrated		Perform calibration
red flashing (6 Hz)			red	red	No single sheet detected during calibration	No sheet inserted or double sheet inserted	Calibrate on single sheet
red flashing (6 Hz)				red flashing (6 Hz)	Amplifier detects insufficient input signal when device switched on	Sheet between the sensors or sensors not connected	Remove sheet and acknowledge with the TEACH IN button
red flashing (6 Hz)				red flashing (6 Hz)	Amplifier detects excessively high noise level when device switched on	Extreme background noise	Dampen background noises, e.g. using foam
	rapid yellow flashing			rapid red flashing	Current at output too high	Short circuit	Switch off voltage, check wiring
red flashing (3 Hz)				red	Fatal memory error	Defect	Have repaired by Leuze electronic

## 10 Application-specific extension types

The amplifier types described below are used for the adaptation to specific applications. They are used instead of the standard amplifier types.

### 10.1 VDB 12 B/6.10P - Detection of splices on blister material

This amplifier corresponds to the VDB 12B/6P with regard to the technical and electrical data. The software is adapted for splice detection on plastic rolls (blister material). That is, the system is more sensitive for the detection of two layers (splices). This does however require the reduction of the flutter range to a maximum of 2mm.

The function of the push-pull switching outputs is inverted. That is, the PNP outputs for single and double sheets are activated if there is no material between the sensors.

After applying the supply voltage, the check of operational readiness is deactivated because at switching on, material may be present between the sensors in the application.

Designation	Model	Part No.
Amplifier (positive logic) for splice detection	VDB 12 B/6.10P	501 07312

### 10.2 VDB 12 B/6.11N - Automatic teach on first sheet

This amplifier corresponds to the VDB 12B/6N with regard to the technical and electrical data. At delivery, the amplifier is preconfigured to the operating mode "automatic teach on first sheet".

This customer-specific configuration features what is called FAST TEACH-IN in the "automatic teach on first sheet" teach mode. The reaction time (TEACH-IN delay) is 1 ms. A new automatic teach-in is carried out if the ultrasonic path is clear for more than 2s.

The detection range covers papers between 40g/m<sup>2</sup> and 450g/m<sup>2</sup>.

Designation	Model	Part No.
Amplifier (negative logic) for automatic teach	VDB 12 B/6.11N	501 07511

### 10.3 VDB 12B/6.12P - without teach button in the cover

This amplifier corresponds to the VDB 12B/6P with regard to technical and electrical data as well as the software. The devices are delivered with "manual teach" operating mode.

The calibration on the material to be detected is performed using pin 5 on the M12 connector.

Designation	Model	Part No.
Amplifier (positive logic) without teach button in the cover	VDB 12 B/6.12P	501 09781



#### **Notice!**

To enter alignment mode, the 2-pin pin strip directly on the PCB can be bridged for longer than 5s. Afterwards, alignment can be carried out as described in chapter 7.