



COAXIAL

# Broadband Slope Equalizer

## ZEQ-7-44K+

50Ω DC to 40 GHz 2.92mm Female

### THE BIG DEAL

- Wide band operation, DC to 40 GHz
- Negative insertion loss slope of 6.5 dB typ. (other slope values available)
- Internally matched to 50 Ohm
- Minimal slope deviation of  $\pm 0.4$  dB typical
- Small form-factor 0.56 x 0.56 inches
- Power Handling of +27 dBm

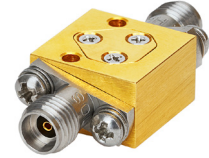

Generic photo used for illustration purposes only

Model No.	ZEQ-7-44K+
Case Style	UK2938-2
Connectors	2.92mm Female (K-type)

### APPLICATIONS

- Amplifier gain slope compensation
- Cable loss compensation
- Ka and Ku band satellite communications
- 5G mmW systems

**+RoHS Compliant**  
 The +Suffix identifies RoHS Compliance.  
 See our website for methodologies and qualifications

### PRODUCT OVERVIEW

Mini-Circuits' ZEQ-7-44K+ is a broadband, connectorized negative insertion loss slope equalizer, with a slope of 6.5 dB typ. over the range of DC to 40 GHz. The model is bi-directional and offers excellent electrical performance in applications where frequency dependent transmission line losses (negative gain slope) hinder the overall system performance. Model ZEQ-7-44K+ is a great choice for compensating negative gain slope of amplifiers, receivers and transmitters to achieve a flat gain response with respect to frequency.

### KEY FEATURES

Features	Advantages
Minimal slope deviation of $\pm 0.4$ dB (typ.)	Provides low signal distortion over the broadband range from DC to 40 GHz
Good 50 Ohm match over broadband	Model offers good return loss of 15 dB (typ.) over entire band, minimizing signal distortion
Small form factor	Model is offered in a small case size of 0.56 " x 0.56 " providing advantages in densely clustered systems
Wide operating temperature	The device operates over a wide temperature range of -40 °C to +85 °C with slope deviation of $\pm 0.4$ dB (typ.)





COAXIAL

# Broadband Slope Equalizer

## ZEQ-7-44K+

50Ω DC to 40 GHz 2.92mm Female

### ELECTRICAL SPECIFICATIONS AT 25°C

Parameter	Condition (GHz)	Min.	Typ.	Max.	Units
Frequency Range	-	0.01	-	40	GHz
Insertion Loss	0.01	8.2	8.7	9.2	dB
	10	6.9	7.5	8.1	
	20	-	5.5	-	
	30	2.9	3.5	4.4	
	40	-	2.3	-	
VSWR	0.01-10	-	1.15	-	:1
	10-20	-	1.2	-	
	20-40	-	1.4	-	

### MAXIMUM RATINGS

Parameter	Ratings
Operating Case Temperature	-40 °C to +85 °C
Storage Temperature	-55 °C to +100 °C
Input Power*	+27 dBm

Permanent damage may occur if any of these limits are exceeded.  
 \*Max. RF power rating is the same in either direction.  
 Derate to +23 dBm at 85 °C

### SIMPLIFIED FUNCTIONAL SCHEMATIC

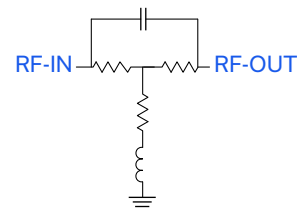

### TYPICAL FREQUENCY RESPONSE

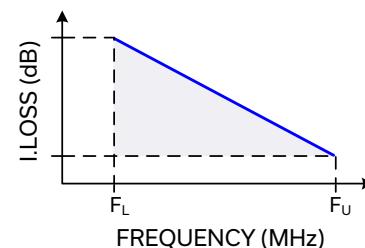



# COAXIAL

# Broadband Slope Equalizer

# ZEQ-7-44K+

50Ω DC to 40 GHz 2.92mm Female

### COAXIAL CONNECTIONS

Input	2.92mm Female
Output	2.92mm Female

### OUTLINE DRAWING

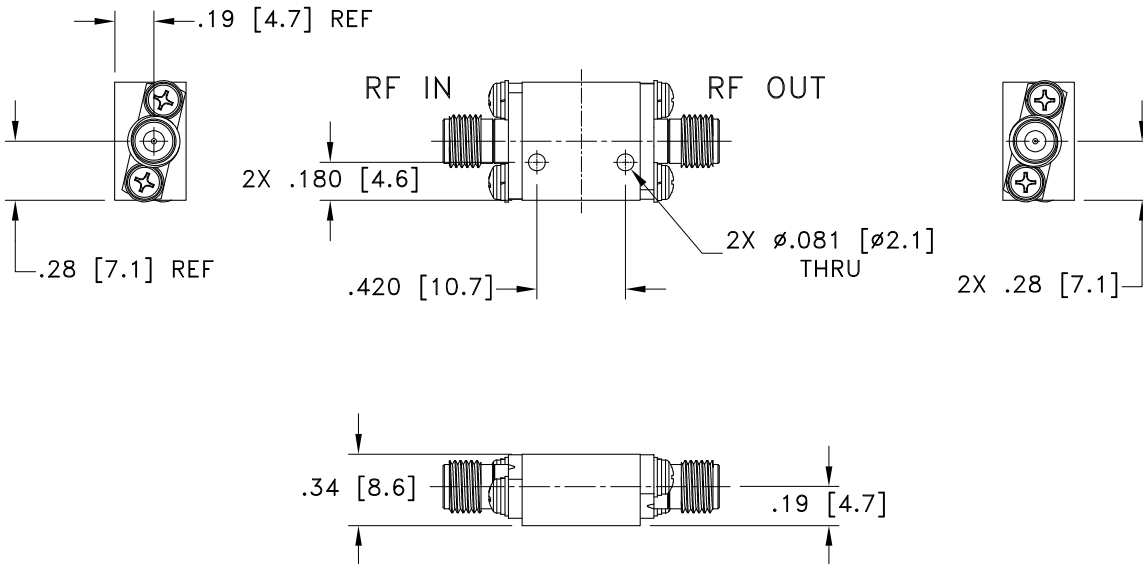
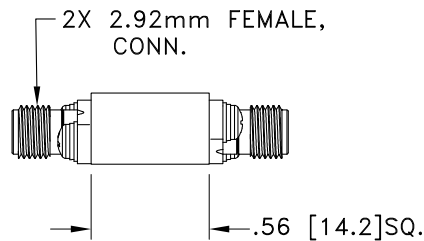

Weight: 20 grams; Dimensions are in inches [mm]. Tolerances: 2 Pl.±.03; 3 Pl. ±.015



COAXIAL

# Broadband Slope Equalizer

## ZEQ-7-44K+

50Ω DC to 40 GHz 2.92mm Female

### TYPICAL PERFORMANCE DATA AND CHARTS

Frequency (MHz)	Insertion Loss (dB)	VSWR (:1)	
		2.92mm RF-IN	2.92mm RF-OUT
10	8.66	1.10	1.10
3000	8.74	1.13	1.16
6000	8.35	1.11	1.14
9000	7.79	1.07	1.07
12000	7.15	1.10	1.12
15000	6.49	1.09	1.19
18000	5.82	1.07	1.28
21000	5.24	1.19	1.37
24000	4.66	1.41	1.44
27000	3.93	1.21	1.10
30000	3.46	1.07	1.21
32000	3.34	1.13	1.36
34000	3.13	1.11	1.41
36000	3.21	1.39	1.50
38000	2.94	1.60	1.72
40000	2.38	1.43	1.55

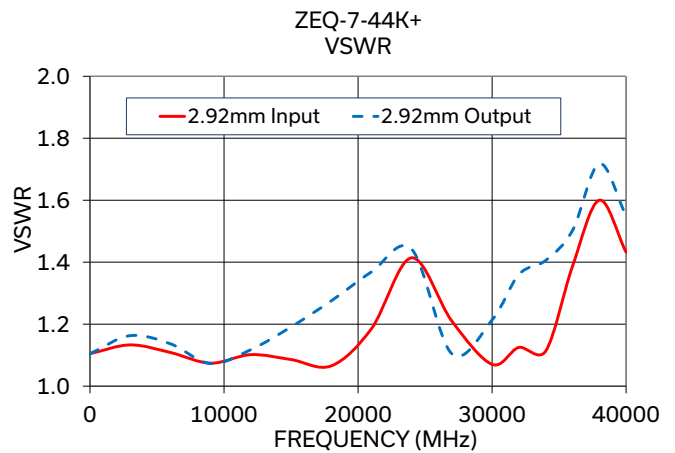
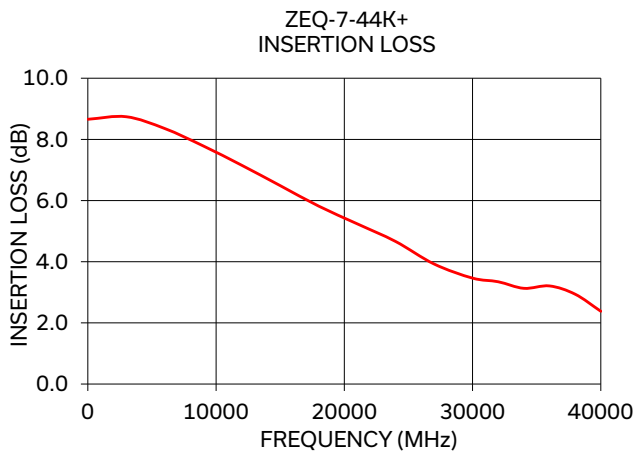

- NOTES**
- A. Performance and quality attributes and conditions not expressly stated in this specification document are intended to be excluded and do not form a part of this specification document.
  - B. Electrical specifications and performance data contained in this specification document are based on Mini-Circuit's applicable established test performance criteria and measurement instructions.
  - C. The parts covered by this specification document are subject to Mini-Circuits standard limited warranty and terms and conditions (collectively, "Standard Terms"); Purchasers of this part are entitled to the rights and benefits contained therein. For a full statement of the standard terms and the exclusive rights and remedies thereunder, please visit Mini-Circuits' website at [www.minicircuits.com/terms/viewterm.html](http://www.minicircuits.com/terms/viewterm.html)

