

High IP3

Low Noise Amplifier

ZHL-3010+

50Ω Medium High Power 50 to 1000 MHz

Features

- wideband, 50 to 1000 MHz
- low noise, 5.5 dB typ.
- high IP3, +46 dBm typ.
- very high IP2, 68-83 dBm typ.
- protected by US Patent 6,943,629

Applications

- VHF/UHF
- cellular
- test equipment
- instrumentation
- laboratory



Generic photo used for illustration purposes only

CASE STYLE: S32

Connectors Model
SMA ZHL-3010+

+RoHS Compliant

The +Suffix identifies RoHS Compliance. See our web site for RoHS Compliance methodologies and qualifications

Electrical Specifications

MODEL NO.	FREQ. (MHz)		GAIN (dB)		MAXIMUM POWER OUTPUT (dBm)		DYNAMIC RANGE		VSWR (:1) Max.		DC POWER	
	f_L	f_U	Min.	Flatness Max.	(1 dB Compr.) Min.	Input (no damage)	NF (dB) Typ.	IP3 (dBm) Typ.	In	Out	Volt (V) Nom.	Current (A) Max.
ZHL-3010+	50	1000	30	±1.0	+26	-3	5.5	+46	2.5	2.0	12	1.0

Open load is not recommended, potentially can cause damage.
With no load derate max input power by 20 dB

Maximum Ratings

Operating Temperature -20°C to 65°C

Storage Temperature -55°C to 100°C

DC Voltage +13V Max.

Permanent damage may occur if any of these limits are exceeded.

Outline Drawing

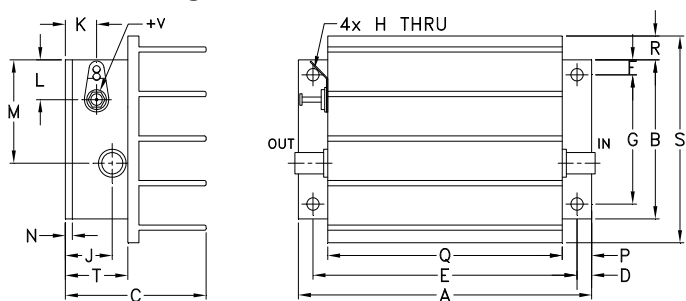

MOUNTING INFORMATION FOR MODELS WITHOUT HEATSINK

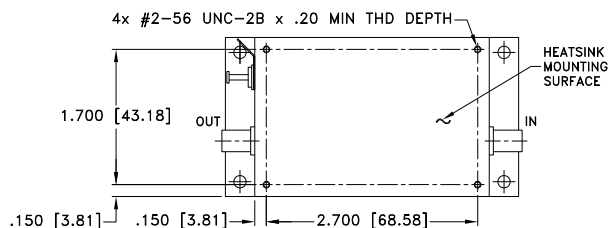

Outline Dimensions (inch/mm)

A	B	C	D	E	F	G	H	J	K	L	M	N	P	Q	R	S	T	wt	
3.75	2.00	1.80	.19	3.375	.19	1.625	.144	.50	.40	.50	1.30	.10	.38	3.00	.30	2.60	.80	grams	
95.25	50.80	45.72	4.83	85.73	4.83	41.28	3.66	12.70	10.16	12.70	33.02	2.54	9.65	76.20	7.62	66.04	20.32	220.0	
																		wt. w/o heat sink	150

Notes

- Performance and quality attributes and conditions not expressly stated in this specification document are intended to be excluded and do not form a part of this specification document.
- Electrical specifications and performance data contained in this specification document are based on Mini-Circuit's applicable established test performance criteria and measurement instructions.
- The parts covered by this specification document are subject to Mini-Circuits standard limited warranty and terms and conditions (collectively, "Standard Terms"); Purchasers of this part are entitled to the rights and benefits contained therein. For a full statement of the Standard Terms and the exclusive rights and remedies thereunder, please visit Mini-Circuits' website at www.minicircuits.com/MCLStore/terms.jsp



FREQUENCY (MHz)	GAIN (dB)	DIRECTIVITY (dB)	VSWR (:1)		NOISE FIGURE (dB)	POUT at 1 dB COMPR. (dBm)
	12V	12V	IN	OUT	12V	12V
50.00	36.37	16.10	1.78	1.28	5.14	29.62
155.60	36.23	15.10	2.12	1.77	5.19	30.12
261.10	36.00	15.80	2.19	1.81	5.40	30.67
366.70	36.09	16.50	2.04	1.44	5.44	31.55
472.20	36.21	16.40	1.94	1.07	5.46	30.87
577.80	36.00	15.30	1.91	1.15	5.40	30.76
683.30	35.30	18.20	1.74	1.18	5.30	30.08
788.90	35.60	18.60	1.88	1.01	5.24	30.18
894.40	35.48	17.40	2.08	1.27	5.33	29.93
1000.00	35.29	20.20	2.04	1.56	5.43	28.74

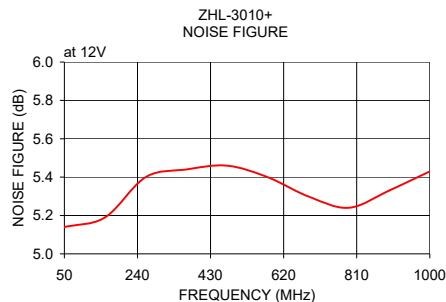
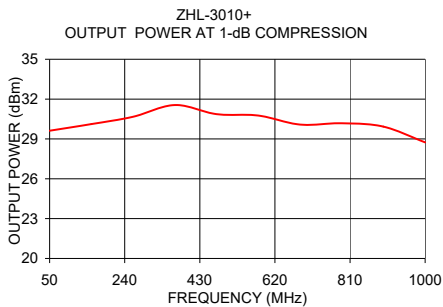
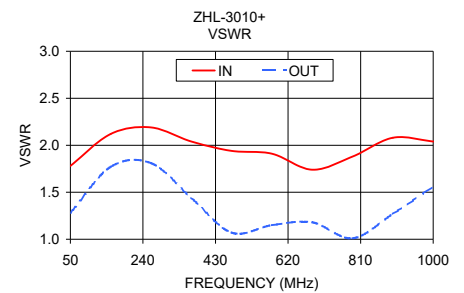
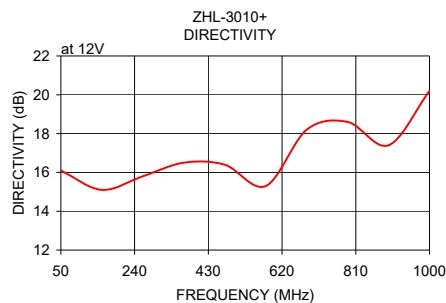
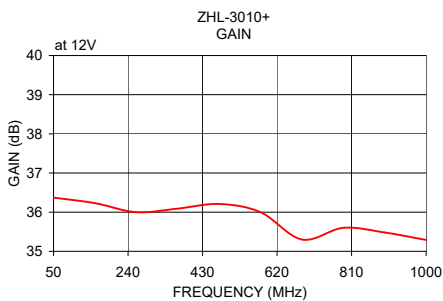

Notes

- A. Performance and quality attributes and conditions not expressly stated in this specification document are intended to be excluded and do not form a part of this specification document.
- B. Electrical specifications and performance data contained in this specification document are based on Mini-Circuit's applicable established test performance criteria and measurement instructions.
- C. The parts covered by this specification document are subject to Mini-Circuits standard limited warranty and terms and conditions (collectively, "Standard Terms"); Purchasers of this part are entitled to the rights and benefits contained therein. For a full statement of the Standard Terms and the exclusive rights and remedies thereunder, please visit Mini-Circuits' website at www.minicircuits.com/MCLStore/terms.jsp