

Super Ultra Wideband Amplifier

ZVA-213+

50Ω 800 MHz to 21 GHz

Features

- super ultra-wideband, 800 MHz to 21 GHz
- high output IP3, +33 dBm typ.
- rugged, compact case (including heat sink)
- unconditionally stable
- good matching at input and output
- withstands open/short load at 1dB compression point output power
- very good isolation, 75 dB typ.



Model No.	ZVA-213-S+	▲ ZVA-213X-S+
Case Style	AV1280	
Connectors	SMA	

Applications

- radar
- very wideband test instrumentation
- lab use
- wideband isolaton, directivity 50 dB typ.

+RoHS Compliant

The +Suffix identifies RoHS Compliance. See our web site for RoHS Compliance methodologies and qualifications

Electrical Specifications at 25°C

Parameter	Condition (MHz)	ZVA-213+ ▲ ZVA-213X+			Units
		Min.	Typ.	Max.	
Frequency Range		800	—	21000	MHz
Gain	800 - 21000	20	26	—	dB
Gain Flatness	800 - 21000	—	±2.0	—	dB
Output Power at 1dB compression	800 - 21000	—	24	—	dBm
Noise Figure	800 - 21000	—	3.0	5.5	dB
Output third order intercept point	800 - 21000	—	+33	—	dBm
Input VSWR	800 - 21000	—	1.35	—	:1
Output VSWR	800 - 21000	—	1.25	—	:1
DC Supply Voltage		—	12*	—	V
Supply Current		—	—	400	mA

* Recommended Operating Voltage.

▲Heat sink not included. Alternative heat sinking and heat removal must be provided by the user to limit maximum base-plate temperature to 85°C, in order to ensure proper performance. For reference, this requires thermal resistance of user's external heat sink to be 4°C/W max.

Maximum Ratings

Parameter	Ratings
Operating Temperature	-55°C to 85°C base plate temp.
Storage Temperature	-65°C to 150°C
DC Voltage	15V
CW Input RF Power (no damage)	+4 dBm

Permanent damage may occur if any of these limits are exceeded.

Notes

- Performance and quality attributes and conditions not expressly stated in this specification document are intended to be excluded and do not form a part of this specification document.
- Electrical specifications and performance data contained in this specification document are based on Mini-Circuit's applicable established test performance criteria and measurement instructions.
- The parts covered by this specification document are subject to Mini-Circuits standard limited warranty and terms and conditions (collectively, "Standard Terms"); Purchasers of this part are entitled to the rights and benefits contained therein. For a full statement of the Standard Terms and the exclusive rights and remedies thereunder, please visit Mini-Circuits' website at www.minicircuits.com/MCLStore/terms.jsp



Outline Drawing for models with heatsink

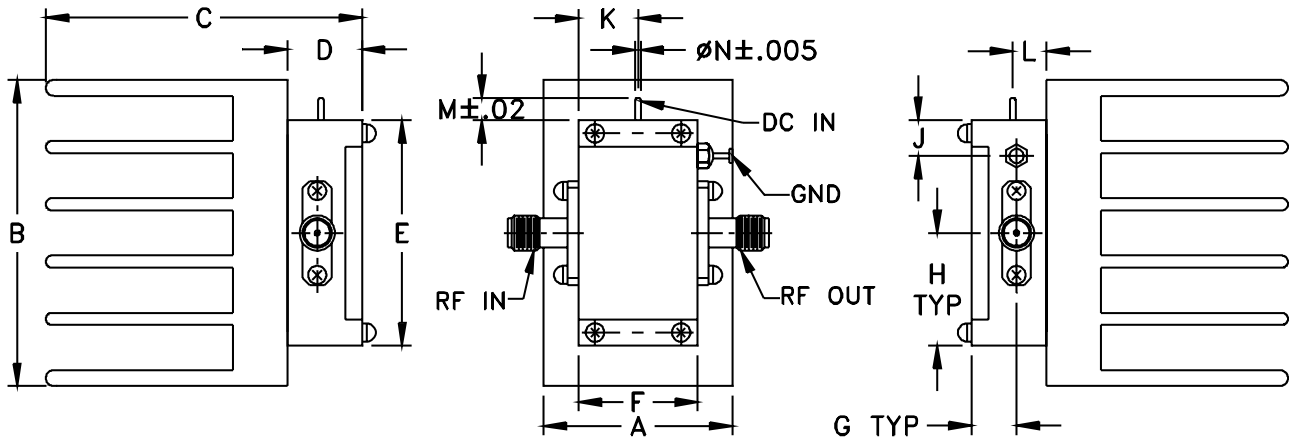

Outline Drawing for models without heatsink

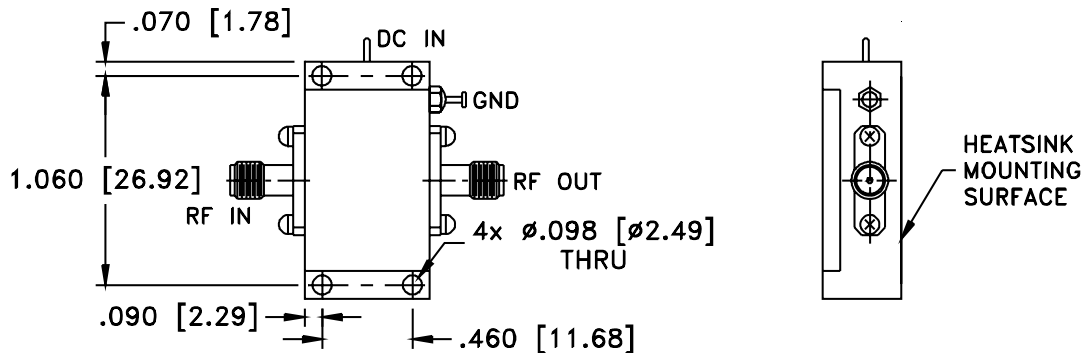

Outline Dimensions (inch/mm)

A	B	C	D	E	F	G	H	J	K	L	M	N	wt
1.01	1.63	1.69	.45	1.20	.64	.24	.60	.19	.32	.27	.12	.03	grams*
25.65	41.40	42.93	11.43	30.48	16.26	6.10	15.24	4.83	8.13	6.86	3.05	0.76	58

*17 grams without heatsink

Notes

- Performance and quality attributes and conditions not expressly stated in this specification document are intended to be excluded and do not form a part of this specification document.
- Electrical specifications and performance data contained in this specification document are based on Mini-Circuit's applicable established test performance criteria and measurement instructions.
- The parts covered by this specification document are subject to Mini-Circuits standard limited warranty and terms and conditions (collectively, "Standard Terms"); Purchasers of this part are entitled to the rights and benefits contained therein. For a full statement of the Standard Terms and the exclusive rights and remedies thereunder, please visit Mini-Circuits' website at www.minicircuits.com/MCLStore/terms.jsp



FREQUENCY (MHz)	GAIN (dB)	DIRECTIVITY (dB)	VSWR (:1)		NOISE FIGURE (dB)	POUT at 1 dB COMPR. (dBm)	FREQUENCY (MHz)	IP3 (dBm)
	12V	12V	IN	OUT	12V	12V		
800.00	26.32	49.16	1.47	1.64	4.74	23.89	800.00	36.82
900.00	26.40	50.96	1.43	1.58	4.68	23.80	900.00	37.38
1000.00	26.45	49.60	1.40	1.53	4.66	23.67	1000.00	37.33
1100.00	26.49	54.43	1.38	1.50	4.7	23.73	2000.00	36.86
2000.00	26.83	49.44	1.27	1.28	3.91	23.95	3000.00	36.24
3000.00	26.88	54.76	1.24	1.07	3.46	24.39	4000.00	35.58
4000.00	26.87	50.02	1.23	1.21	3.19	24.80	5000.00	35.1
5000.00	26.75	50.10	1.23	1.41	2.89	25.08	6000.00	34.38
6000.00	26.68	47.03	1.26	1.46	2.74	25.04	7000.00	33.78
7000.00	26.64	49.03	1.30	1.35	2.56	25.43	8000.00	33.26
8000.00	26.53	52.49	1.34	1.17	2.49	25.34	9000.00	32.62
9000.00	26.42	59.55	1.36	1.19	2.48	25.23	10000.00	32.09
10000.00	26.23	53.89	1.36	1.39	2.63	25.09	11000.00	31.27
11000.00	26.12	54.33	1.38	1.52	2.87	24.73	12000.00	30.49
12000.00	26.28	38.47	1.37	1.37	3.25	24.14	13000.00	30.47
13000.00	26.27	56.13	1.37	1.02	3.33	23.68	14000.00	30.19
14000.00	26.03	43.11	1.40	1.38	3.14	23.31	15000.00	29.63
15000.00	26.04	44.40	1.34	1.55	3.31	23.24	16000.00	29.01
16000.00	26.21	34.69	1.12	1.36	3.26	23.06	17000.00	28.88
17000.00	25.90	33.52	1.08	1.01	3.41	22.76	18000.00	28.98
18000.00	25.12	37.12	1.16	1.37	3.72	21.65	19000.00	29.87
19000.00	24.47	36.33	1.15	1.47	4.11	20.85	19500.00	27.95
20000.00	24.06	36.02	1.27	1.27	4.06	19.74		
21000.00	22.91	34.26	1.38	1.17	4.35	18.57		

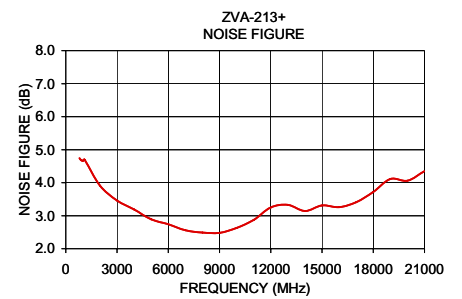
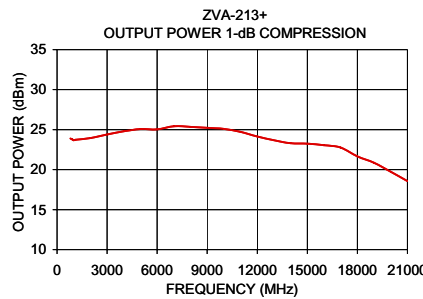
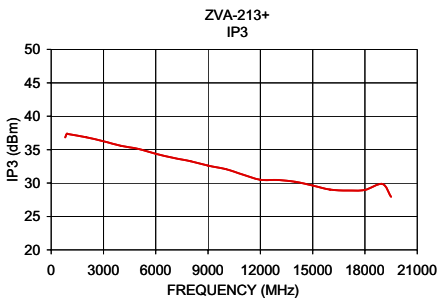
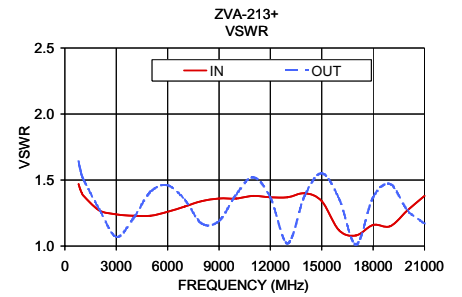
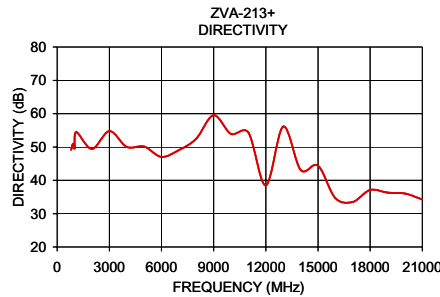
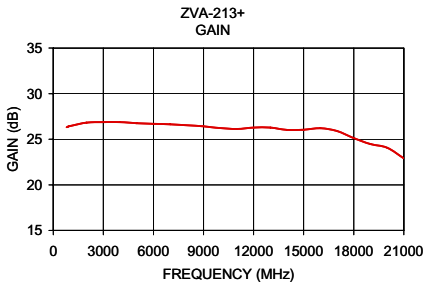

Notes

- A. Performance and quality attributes and conditions not expressly stated in this specification document are intended to be excluded and do not form a part of this specification document.
- B. Electrical specifications and performance data contained in this specification document are based on Mini-Circuit's applicable established test performance criteria and measurement instructions.
- C. The parts covered by this specification document are subject to Mini-Circuits standard limited warranty and terms and conditions (collectively, "Standard Terms"); Purchasers of this part are entitled to the rights and benefits contained therein. For a full statement of the Standard Terms and the exclusive rights and remedies thereunder, please visit Mini-Circuits' website at www.minicircuits.com/MCLStore/terms.jsp

