

NON-CATALOG

Digital Step Attenuator

50Ω DC-2400 MHz

31.5 dB, 0.5 dB Step, 6 Bit, Parallel Control Interface
Dual Supply Voltage

Product Features

- Low Insertion Loss
- High IP3, +52 dBm Typ
- Excellent return loss, 20 dB Typ
- Excellent accuracy, 0.1 dB Typ
- Fast switching control frequency, 1 MHz typ.
- Dual Supply Voltage: $V_{DD}=+3V$, $V_{SS}=-3V$
- Control inputs buffered by Schmitt Triggers
- Rigid unibody case
- Protected by US patent 6,790,049

Typical Applications

- Lab
- Instrumentation
- Test equipment

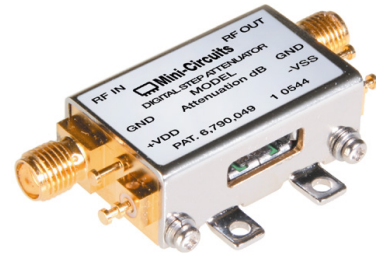

CASE STYLE: HK1149

ZX76-31R5-PN-S+

Connectors	Order P/N
SMA	ZX76-31R5-PN-S+

+RoHS Compliant

The +Suffix identifies RoHS Compliance. See our web site for RoHS Compliance methodologies and qualifications

General Description

The ZX76-31R5-PN-S+ is a 50Ω RF digital step attenuator that offers an attenuation range up to 31.5 dB in 0.5 dB steps. The control is a 6-bit parallel interface. The model operates on a dual supply voltage: $V_{DD}=+3V$, $V_{SS}=-3V$. See application note AN-70-004 for 5V supply voltage. The ZX76-31R5-PN-S+ is produced using a unique case package for ruggedness and operation in tough environments.

Simplified Schematic

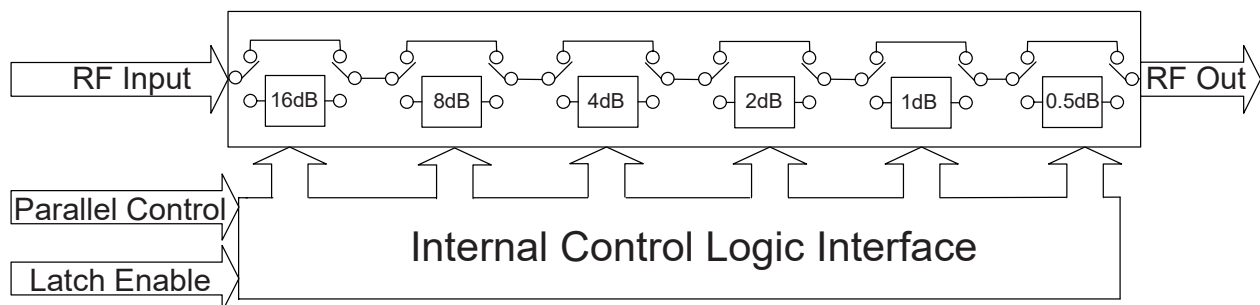

NON-CATALOG

Digital Step Attenuator

ZX76-31R5-PN-S+

RF Electrical Specifications, DC-2400 MHz, $T_{AMB}=25^{\circ}C$, $V_{DD}=+3V$, $V_{SS}=-3V$

Parameter	Freq. Range (GHz)	Min.	Typ.	Max.	Units
Accuracy @ 0.5 dB Attenuation Setting	DC-1	—	0.03	0.1	dB
	1-2.4	—	0.05	0.15	dB
Accuracy @ 1 dB Attenuation Setting	DC-1	—	0.02	0.1	dB
	1-2.4	—	0.05	0.15	dB
Accuracy @ 2 dB Attenuation Setting	DC-1	—	0.05	0.15	dB
	1-2.4	—	0.15	0.25	dB
Accuracy @ 4 dB Attenuation Setting	DC-1	—	0.07	0.2	dB
	1-2.4	—	0.15	0.25	dB
Accuracy @ 8 dB Attenuation Setting	DC-1	—	0.03	0.2	dB
	1-2.4	—	0.15	0.3	dB
Accuracy @ 16 dB Attenuation Setting	DC-1	—	0.1	0.3	dB
	1-2.4	—	0.15	0.5	dB
Insertion Loss @ all attenuator set to 0dB	DC-1	—	1.5	2.2	dB
	1-2.4	—	2.0	3.0	dB
IP3 Input* (at Min. and Max. Attenuation)	DC-2.4	—	+52	—	dBm
Input Power @ 0.2dB Compression* (at Min. and Max. Attenuation)	DC-2.4	—	+24	—	dBm
VSWR	DC-1	—	1.2	1.5	—
	1-2.4	—	1.2	1.5	—

* IP3 and 1dB compression degrade below 1 MHz

DC Electrical Specifications

Parameter	Min.	Typ.	Max.	Units
V_{DD} , Supply Voltage	2.7	3	3.3	V
V_{SS} , Supply Voltage	-3.3	-3	-2.7	V
I_{DD} , Supply Current	—	—	3	mA
I_{SS} , Supply Current	—	—	100	μA
Control Input Voltage Low	0	—	$0.3xV_{DD}$	V
Control Input Voltage High	$0.7xV_{DD}$	—	5V	V
Control Current	—	—	400	μA

Switching Specifications

Parameter	Min.	Typ.	Max.	Units
Switching Speed, 50% Control to 0.5dB of Attenuation Value	—	1.0	—	μSec
Switching Control Frequency	—	1.0	—	MHz

Absolute Maximum Ratings

Parameter	Ratings
Operating Temperature	-40°C to 85°C
Storage Temperature	-40°C to 85°C
V_{DD} , Supply Voltage	-0.3V Min., 4V Max.
V_{SS} , Supply Voltage	-4V Min., 0.3V Max.
Voltage on Control Input	-0.3V Min., 6V Max.
ESD, HBM	500V
ESD, MM	100V
Input Power	+24dBm

Permanent damage may occur if any of these limits are exceeded

NON-CATALOG

Digital Step Attenuator

ZX76-31R5-PN-S+

Pin Description

Function	Pin Number	Description
LE	J1-1	Latch Enable Input
C1	J1-2	Control for attenuation bit, 1 dB
C0.5	J1-3	Control for attenuation bit, 0.5 dB
N/C	J1-4	Not Connected
C16	J1-5	Control for attenuation bit, 16 dB
GND	J1-6	Ground connection
GND	J1-7	Ground connection
C4	J1-8	Control for attenuation bit, 4 dB
C8	J1-9	Control for attenuation bit, 8 dB
C2	J1-10	Control for attenuation bit, 2 dB
RF in	J2	RF in port (Note 1)
RF out	J3	RF out port (Note 1)
GND	P1	Ground connection
V _{DD}	P2	Positive Supply Voltage
GND	P3	Ground connection
V _{SS}	P4	Negative Supply Voltage

Note 1: Both RF ports must be held at 0VDC or DC blocked with an external series capacitor.

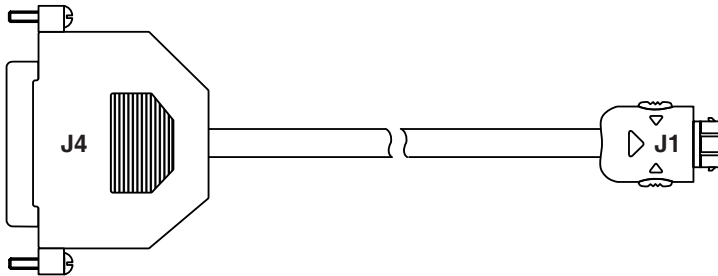

Pin Configuration

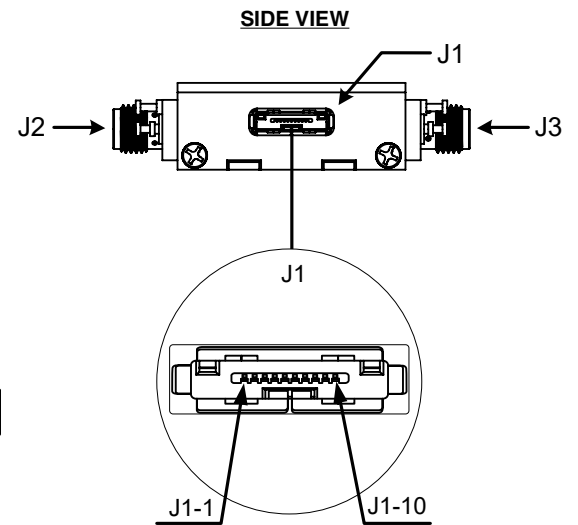
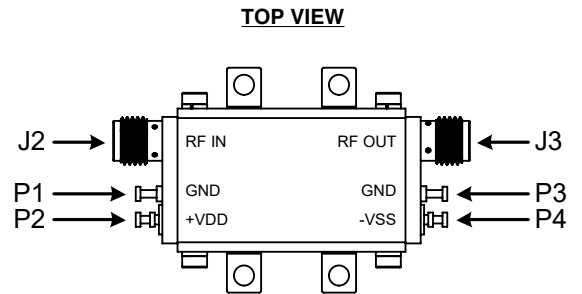

Cable Pin Description

J1-Pin Number	J4-Pin Number	Function	Description	Wire Color
J1-1	J4-8	LE	Latch Enable Input	WHITE
J1-2	J4-3	C1	Control for attenuation bit, 1 dB	YELLOW
J1-3	J4-2	C0.5	Control for attenuation bit, 0.5 dB	GREEN
J1-5	J4-7	C16	Control for attenuation bit, 16 dB	BLUE
J1-6	J4-20	GND	Ground connection	BLACK
J1-8	J4-5	C4	Control for attenuation bit, 4 dB	ORANGE
J1-9	J4-6	C8	Control for attenuation bit, 8 dB	BROWN
J1-10	J4-4	C2	Control for attenuation bit, 2 dB	RED

Note: Other pins not connected. Cable shield connected to case ground.

NON-CATALOG

Digital Step Attenuator

ZX76-31R5-PN-S+

Typical Performance Curves

INSERTION LOSS (Ref)

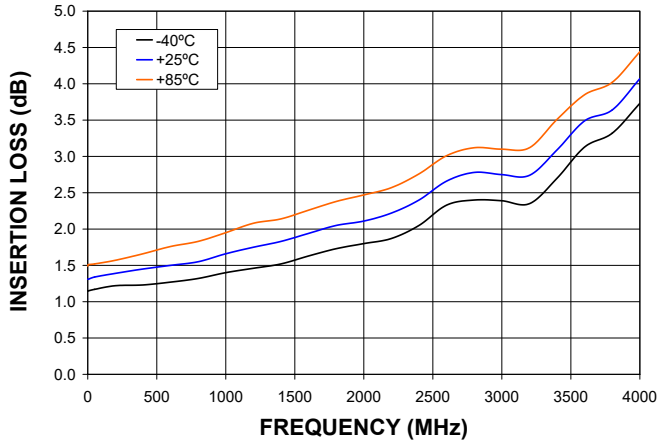

ATTENUATION (0.5 dB)

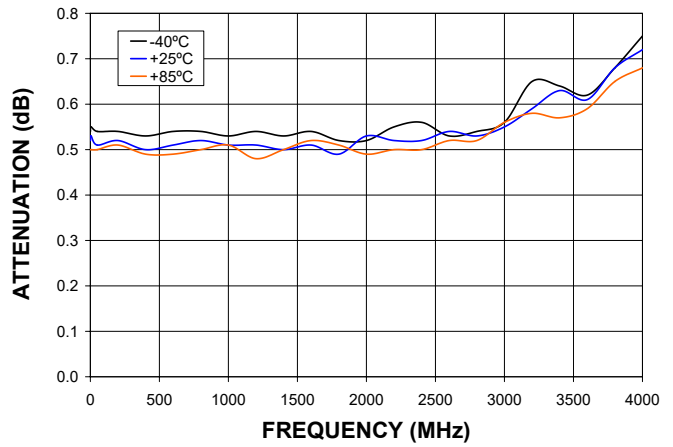

ATTENUATION (1 dB)

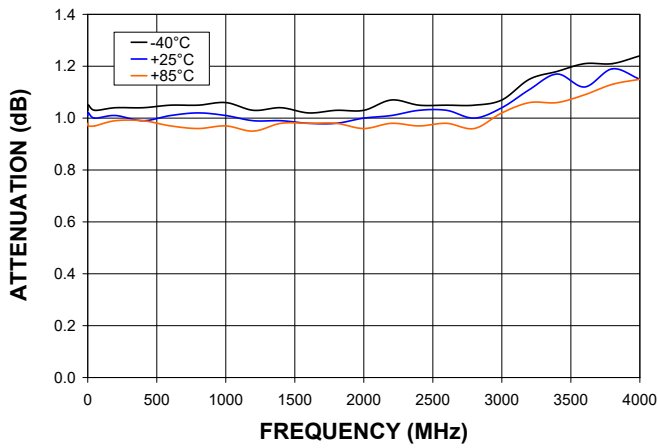

ATTENUATION (2 dB)

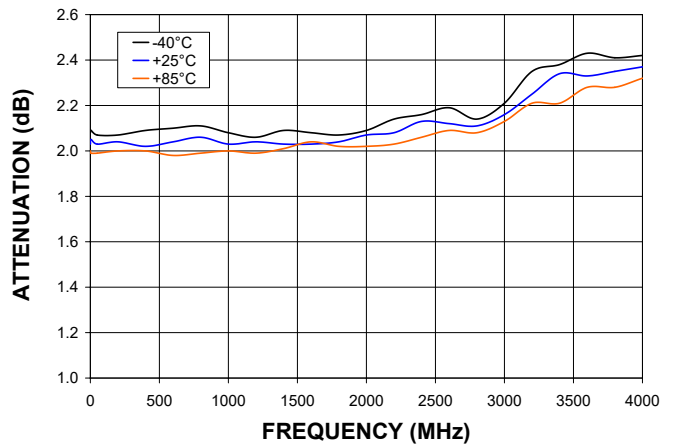

ATTENUATION (4 dB)

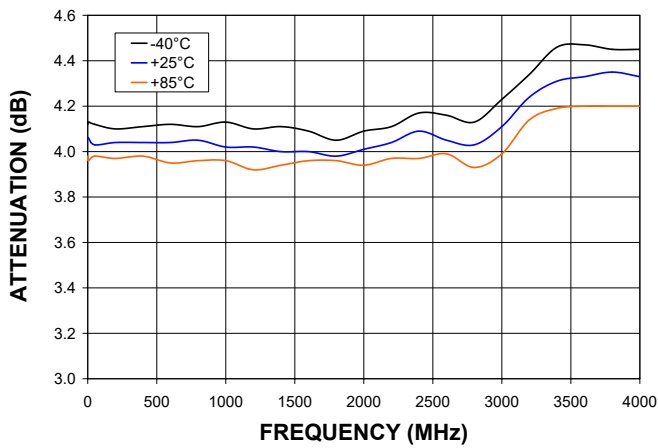

ATTENUATION (8 dB)

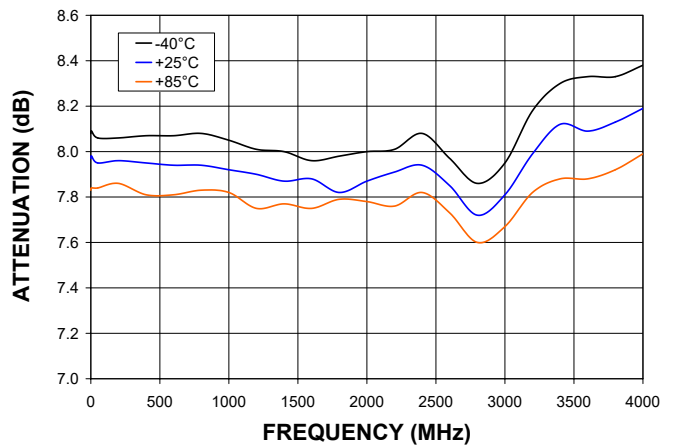

NON-CATALOG

Digital Step Attenuator

ZX76-31R5-PN-S+

Typical Performance Curves

ATTENUATION (16 dB)

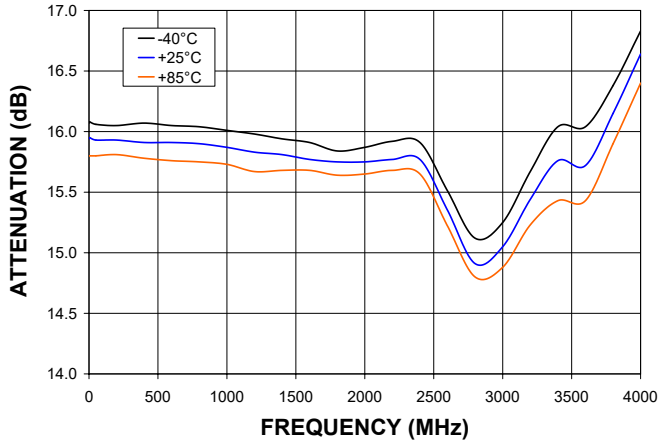

ATTENUATION (31.5 dB)

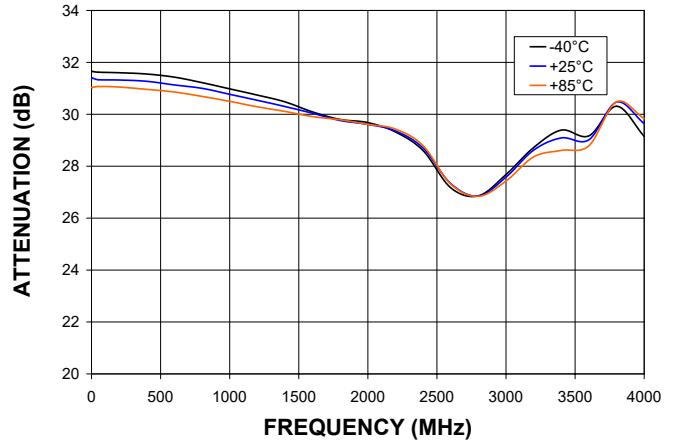

RETURN LOSS IN (Ref)

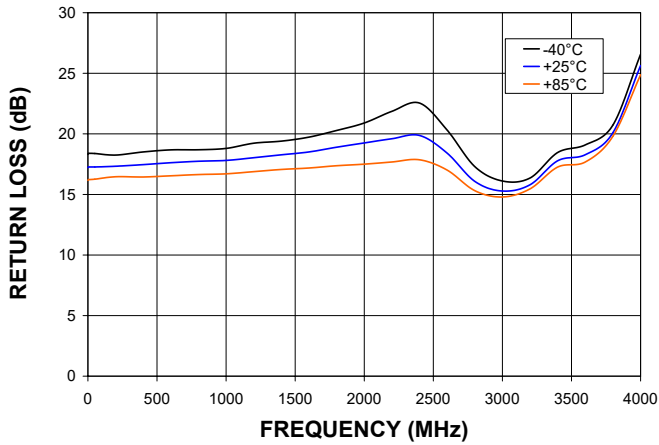

RETURN LOSS OUT (Ref)

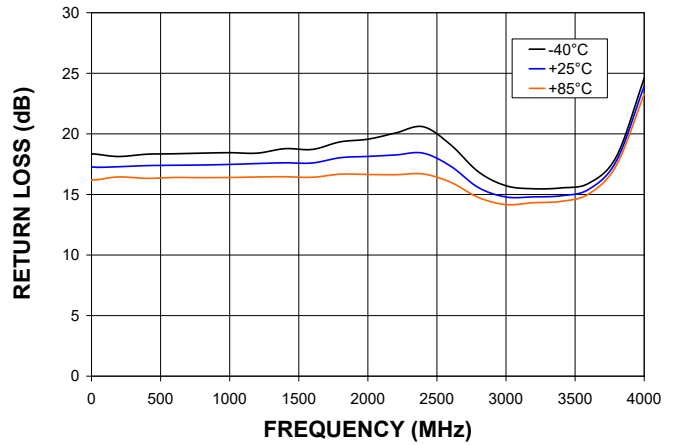

RETURN LOSS IN (Major Atten. Steps) @ +25°C

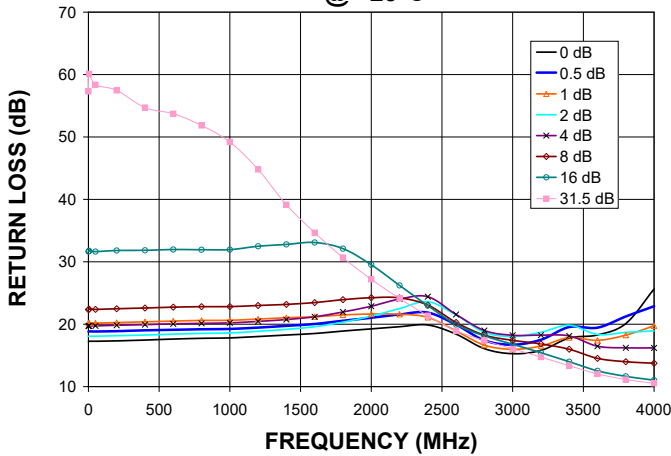

RETURN LOSS OUT (Major Atten. Steps) @ +25°C

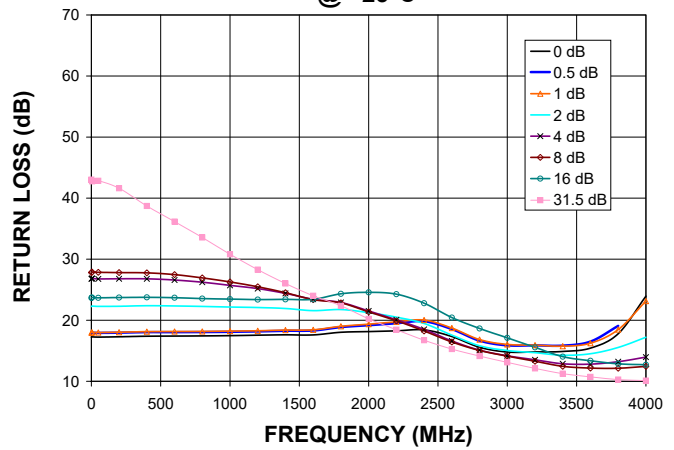

NON-CATALOG

Digital Step Attenuator

ZX76-31R5-PN-S+

Typical Performance Curves

IP3 (Major Atten. Steps) @ +25°C

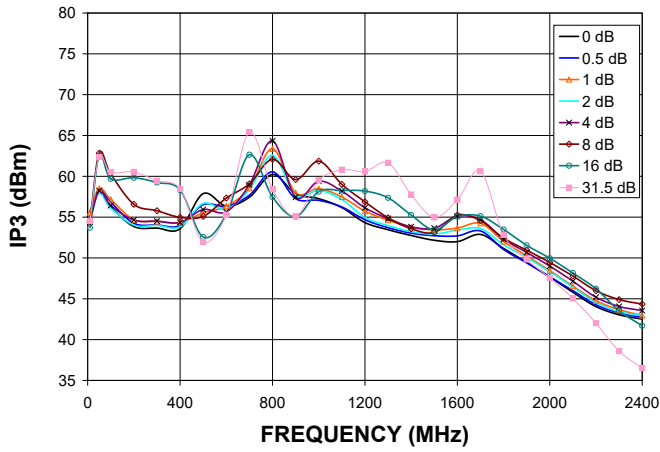

COMPRESSION @ INPUT POWER=+24dBm (Major Atten. Steps) @ +25°C

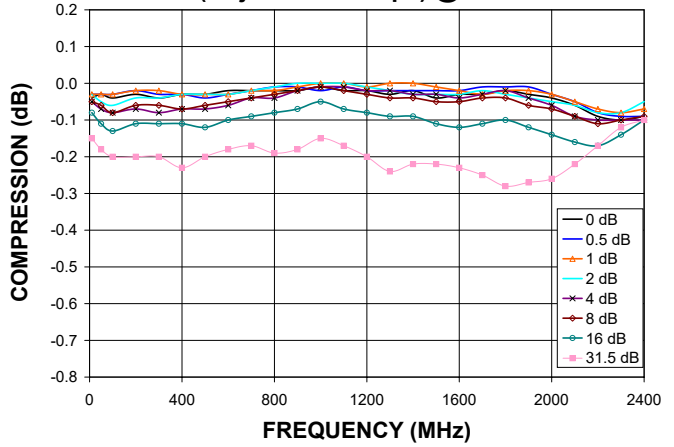

IP3 (Major Atten. Steps) @ -40°C

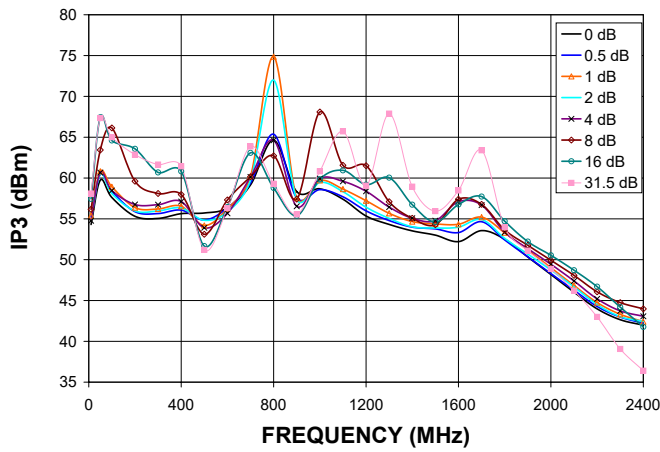

COMPRESSION @ INPUT POWER=+24dBm (Major Atten. Steps) @ -40°C

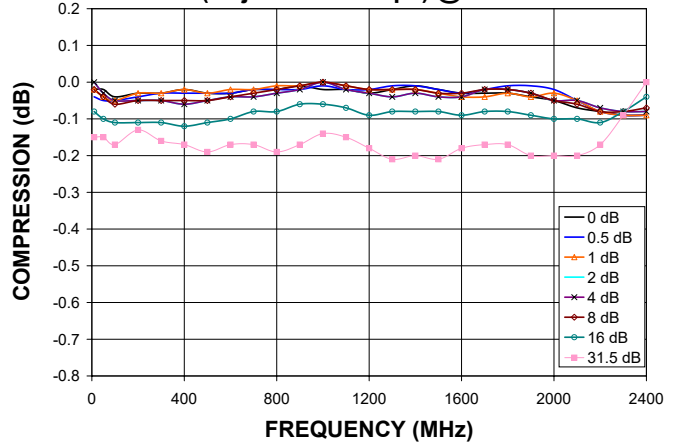

IP3 (Major Atten. Steps) @ +85°C

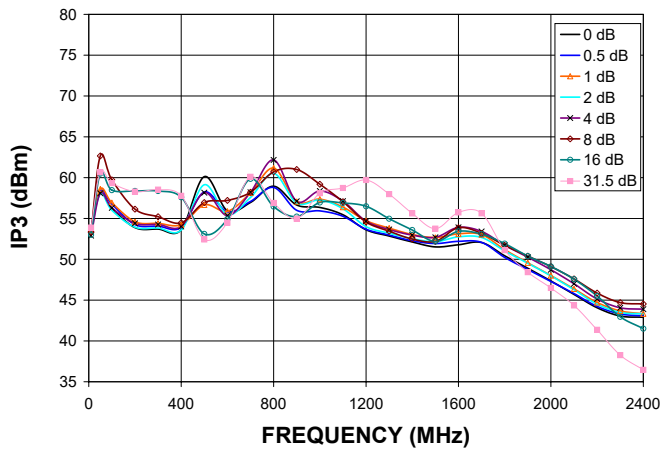

COMPRESSION @ INPUT POWER=+24dBm (Major Atten. Steps) @ +85°C

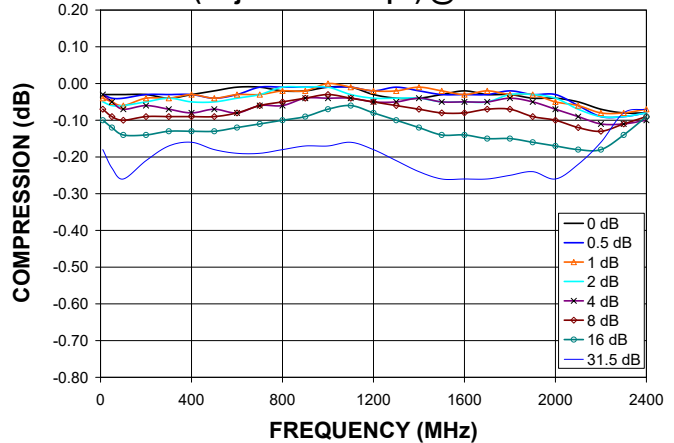

NON-CATALOG

Digital Step Attenuator

ZX76-31R5-PN-S+

Outline Drawing

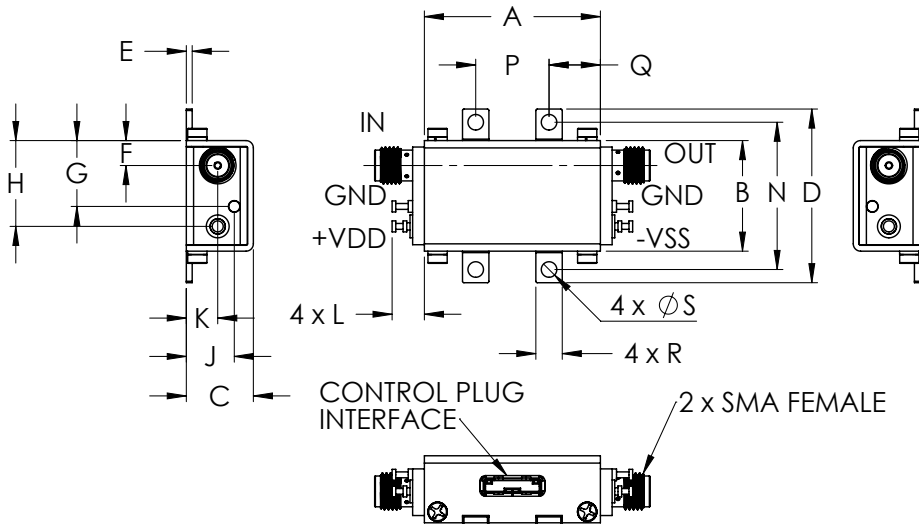

NOTE: When soldering the DC connections, caution must be used to avoid overheating the DC terminals. See Application Note [AN-40-10](#).

Outline Dimensions (inch/mm)

A	B	C	D	E	F	G	H	J	K	L	M	N	P	Q	R	S	WT. GRAMS
1.20	.75	.46	1.18	.04	.17	.45	.59	.33	.21	.22	-	1.00	.50	.35	.18	.106	35
30.48	19.15	11.61	30.07	1.02	4.32	11.40	14.86	8.31	5.44	5.59	-	25.40	12.70	8.89	4.57	2.69	

Recommended Mounting Hardware:

Use UNC#2 pan head screws with internal tooth lock washers for unit mounting.

Simplified Schematic

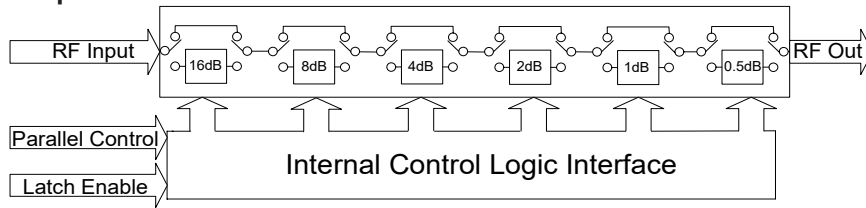

The ZX76-31R5-PN-S+ parallel interface consists of 6 control bits that select the desired attenuation state, as shown in Table 1: Truth Table

Table 1. Truth Table						
Attenuation State	C16	C8	C4	C2	C1	C0.5
Reference	0	0	0	0	0	0
0.5 (dB)	0	0	0	0	0	1
1 (dB)	0	0	0	0	1	0
2 (dB)	0	0	0	1	0	0
4 (dB)	0	0	1	0	0	0
8 (dB)	0	1	0	0	0	0
16 (dB)	1	0	0	0	0	0
31.5 (dB)	1	1	1	1	1	1

Note: Not all 64 possible combinations of C0.5 - C16 are shown in table

The parallel interface timing requirements are defined by Figure 1 (Parallel Interface Timing Diagram) and Table 2 (Parallel Interface AC Characteristics), and switching speed.

For latched parallel programming the Latch Enable (LE) should be held LOW while changing attenuation state control values, then pulse LE HIGH to LOW (per Figure 1) to latch new attenuation state into device.

For direct parallel programming, the Latch Enable (LE) line should be pulled HIGH. Changing attenuation state control values will change device state to new attenuation. Direct mode is ideal for manual control of the device (using hardware, switches, or jumpers).

Control cables for programming can be ordered separately. For details see page 9.

Figure 1: Parallel Interface Timing Diagram

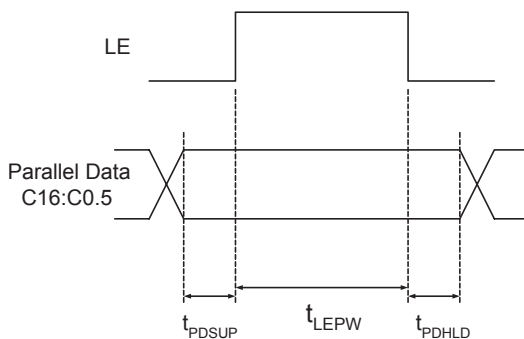

Table 2. Parallel Interface AC Characteristics			
Symbol	Parameter	Min.	Units
t_{LEPW}	LE minimum pulse width	10	ns
t_{PDSUP}	Data set-up time before clock rising edge of LE	10	ns
t_{PDHL}	Data hold time after clock falling edge of LE	10	ns

Power-up State

When the attenuator powers up and LE is logic low, the nominal attenuation is set on 0 dB. When LE is logic high, the nominal attenuation selected upon control logics (see Table 1).

NON-CATALOG

Digital Step Attenuator

ZX76-31R5-PN-S+

Recommended Accessories

Two optional cable accessories with and without interface connector are available with ZX76-31R5-PN-S+, the ZX76-CP+ and ZX76-WP+. Cable length is 4.9 feet / 1.5 meters.

ZX76-CP+ shielded cable with interface 25 pin D-type connector J4 and supplied software are used to control the ZX76-31R5-PN-S+ digital attenuator from a computer, using LPT port.

ZX76-WP+ shielded cable without interface 25 pin D-type connector enables customer to use the ZX76-31R5-PN-S+ digital attenuator in his own application.

ZX76-CP+ Control Cable

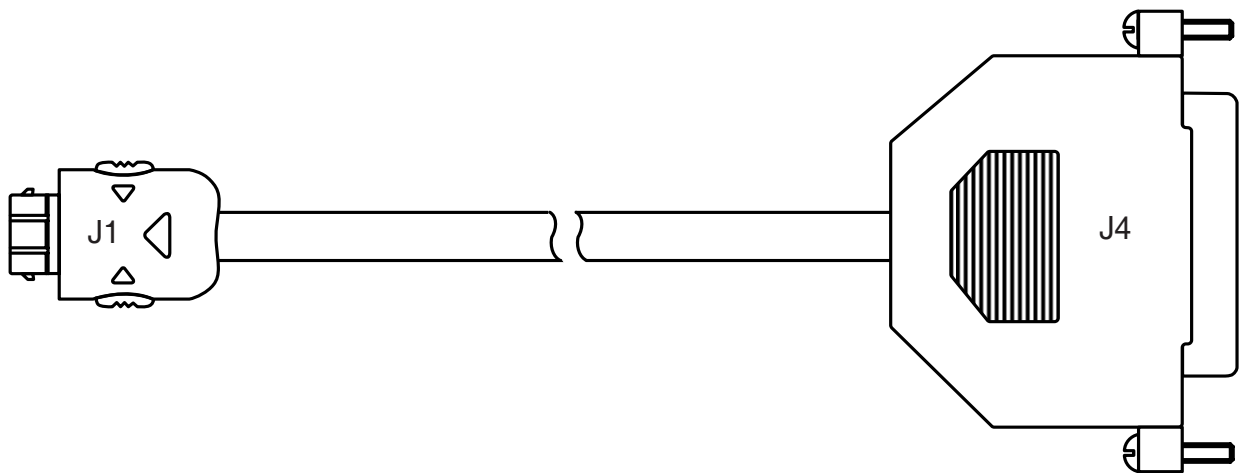

ZX76-CP+ wiring information

J1-Pin Number	J4-Pin Number	Function	Description	Wire Color
J1-1	J4-8	LE	Latch Enable Input	WHITE
J1-2	J4-3	C1	Control for attenuation bit, 1 dB	YELLOW
J1-3	J4-2	C0.5	Control for attenuation bit, 0.5 dB	GREEN
J1-5	J4-7	C16	Control for attenuation bit, 16 dB	BLUE
J1-6	J4-20	GND	Ground connection	BLACK
J1-8	J4-5	C4	Control for attenuation bit, 4 dB	ORANGE
J1-9	J4-6	C8	Control for attenuation bit, 8 dB	BROWN
J1-10	J4-4	C2	Control for attenuation bit, 2 dB	RED

Note: Other pins not connected. Cable shield connected to case ground.

NON-CATALOG

Digital Step Attenuator

ZX76-31R5-PN-S+

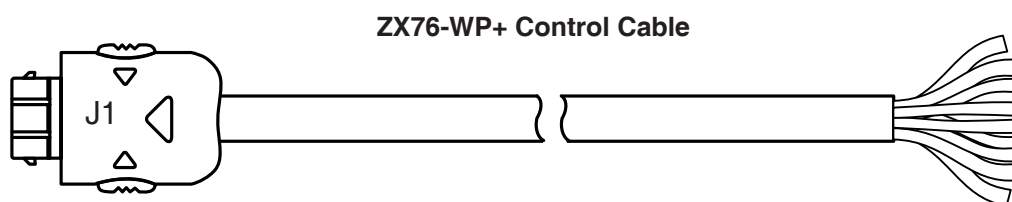

ZX76-WP+ wiring information

Pin Number	Function	Description	Wire Color
J1-1	LE	Latch Enable Input	WHITE
J1-2	C1	Control for attenuation bit, 1 dB	YELLOW
J1-3	C0.5	Control for attenuation bit, 0.5 dB	GREEN
J1-5	C16	Control for attenuation bit, 16 dB	BLUE
J1-6	GND	Ground connection	BLACK
J1-8	C4	Control for attenuation bit, 4 dB	ORANGE
J1-9	C8	Control for attenuation bit, 8 dB	BROWN
J1-10	C2	Control for attenuation bit, 2 dB	RED

Note: Other pins not connected. Cable shield connected to case ground.

Ordering Information

Model Number	Description
ZX76-31R5-PN-S+	Digital attenuator - Parallel interface Dual Voltage (Negative and Positive)
ZX76-CP+	Cable accessory with interface connector
ZX76-WP+	Cable accessory without interface connector

Additional Notes

- A. Performance and quality attributes and conditions not expressly stated in this specification document are intended to be excluded and do not form a part of this specification document.
- B. Electrical specifications and performance data contained in this specification document are based on Mini-Circuit's applicable established test performance criteria and measurement instructions.
- C. The parts covered by this specification document are subject to Mini-Circuits standard limited warranty and terms and conditions (collectively, "Standard Terms"); Purchasers of this part are entitled to the rights and benefits contained therein. For a full statement of the Standard Terms and the exclusive rights and remedies thereunder, please visit Mini-Circuits' website at www.minicircuits.com/MCLStore/terms.jsp

