

NON-CATALOG Digital Step Attenuator

50Ω DC-2400 MHz

31.5 dB, 0.5 dB Step, 6 Bit, Serial Control Interface
Dual Supply Voltage

Product Features

- Low Insertion Loss
- High IP3, +52 dBm Typ
- Excellent return loss, 20 dB Typ
- Excellent accuracy, 0.1 dB Typ
- Fast switching control frequency, 1 MHz typ.
- Dual Supply Voltage: $V_{DD}=+3V$, $V_{SS}=-3V$
- Control inputs buffered by Schmitt Triggers
- Rigid unibody case
- Protected by US patent 6,790,049

Typical Applications

- Lab
- Instrumentation
- Test equipment

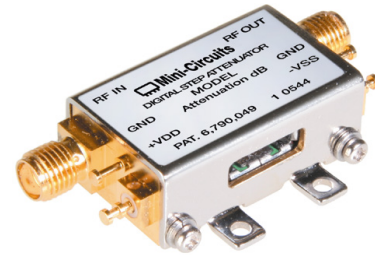

CASE STYLE: HK1149

ZX76-31R5-SN-S+

Connectors	Order P/N
SMA	ZX76-31R5-SN-S+

+RoHS Compliant

The +Suffix identifies RoHS Compliance. See our web site for RoHS Compliance methodologies and qualifications

General Description

The ZX76-31R5-SN-S+ is a 50Ω RF digital step attenuator that offers an attenuation range up to 31.5 dB in 0.5 dB steps. The control is a 6-bit serial interface. The model operates on a dual supply voltage: $V_{DD}=+3V$, $V_{SS}=-3V$. See application note AN-70-004 for 5V supply voltage. The ZX76-31R5-SN-S+ is produced using a unique case package for ruggedness and operation in tough environments.

Simplified Schematic

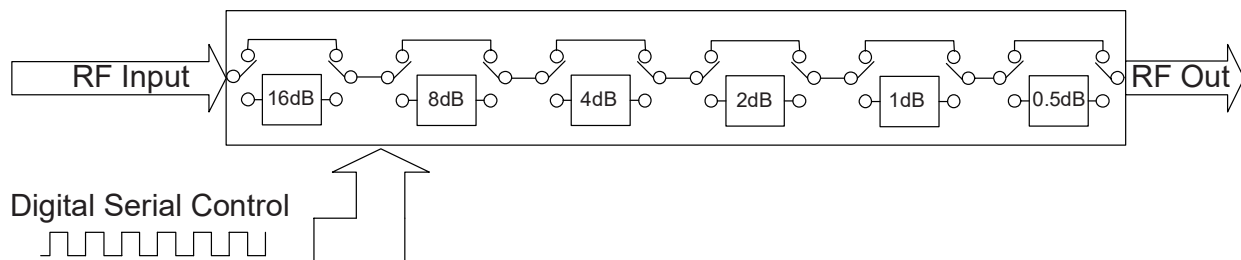

NON-CATALOG

Digital Step Attenuator

ZX76-31R5-SN-S+

RF Electrical Specifications, DC-2400 MHz, $T_{AMB}=25^{\circ}C$, $V_{DD}=+3V$, $V_{SS}=-3V$

Parameter	Freq. Range (GHz)	Min.	Typ.	Max.	Units
Accuracy @ 0.5 dB Attenuation Setting	DC-1	—	0.03	0.1	dB
	1-2.4	—	0.05	0.15	dB
Accuracy @ 1 dB Attenuation Setting	DC-1	—	0.02	0.1	dB
	1-2.4	—	0.05	0.15	dB
Accuracy @ 2 dB Attenuation Setting	DC-1	—	0.05	0.15	dB
	1-2.4	—	0.15	0.25	dB
Accuracy @ 4 dB Attenuation Setting	DC-1	—	0.07	0.2	dB
	1-2.4	—	0.15	0.25	dB
Accuracy @ 8 dB Attenuation Setting	DC-1	—	0.03	0.2	dB
	1-2.4	—	0.15	0.3	dB
Accuracy @ 16 dB Attenuation Setting	DC-1	—	0.1	0.3	dB
	1-2.4	—	0.15	0.5	dB
Insertion Loss @ all attenuator set to 0dB	DC-1	—	1.5	2.2	dB
	1-2.4	—	2.0	3.0	dB
IP3 Input * (at Min. and Max. Attenuation)	DC-2.4	—	+52	—	dBm
Input Power @ 0.2dB Compression* (at Min. and Max. Attenuation)	DC-2.4	—	+24	—	dBm
VSWR	DC-1	—	1.2	1.5	—
	1-2.4	—	1.2	1.5	—

* IP3 and 1dB compression degrade below 1 MHz

DC Electrical Specifications

Parameter	Min.	Typ.	Max.	Units
V_{DD} , Supply Voltage	2.7	3	3.3	V
V_{SS} , Supply Voltage	-3.3	-3	-2.7	V
I_{DD} , Supply Current	—	—	1.5	mA
I_{SS} , Supply Current	—	—	100	μA
Control Input Voltage Low	0	—	$0.3 \times V_{DD}$	V
Control Input Voltage High	$0.7 \times V_{DD}$	—	5V	V
Control Current	—	—	400	μA

Switching Specifications

Parameter	Min.	Typ.	Max.	Units
Switching Speed, 50% Control to 0.5dB of Attenuation Value	—	1.0	—	μSec
Switching Control Frequency	—	1.0	—	MHz

Absolute Maximum Ratings

Parameter	Ratings
Operating Temperature	-40°C to 85°C
Storage Temperature	-40°C to 85°C
V_{DD} , Supply Voltage	-0.3V Min., 4V Max.
V_{SS} , Supply Voltage	-4V Min., 0.3V Max.
Voltage on Control Input	-0.3V Min., 6V Max.
ESD, HBM	500V
ESD, MM	100V
Input Power	+24dBm

Permanent damage may occur if any of these limits are exceeded



NON-CATALOG

Digital Step Attenuator

ZX76-31R5-SN-S+

Pin Description

Function	Pin Number	Description
N/C	J1-1	Not Connected
GND	J1-2	Ground connection
LE	J1-3	Latch Enable Input
N/C	J1-4	Not Connected
GND	J1-5	Ground connection
N/C	J1-6	Not Connected
Clock	J1-7	Serial Interface clock Input
GND	J1-8	Ground connection
Data	J1-9	Serial Interface data Input
N/C	J1-10	Not Connected
RF in	J2	RF in port (Note 1)
RF out	J3	RF out port (Note 1)
GND	P1	Ground connection
V _{DD}	P2	Positive Supply Voltage
GND	P3	Ground connection
V _{SS}	P4	Negative Supply Voltage

Note 1: Both RF ports must be held at 0VDC or DC blocked with an external series capacitor.

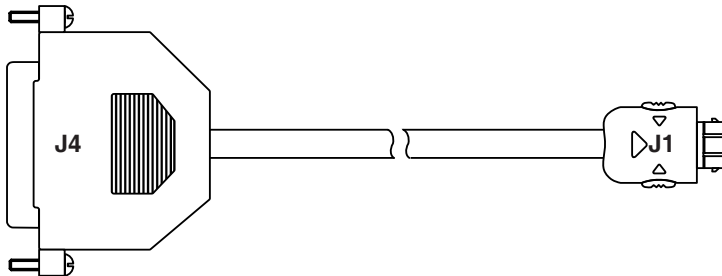

Pin Configuration

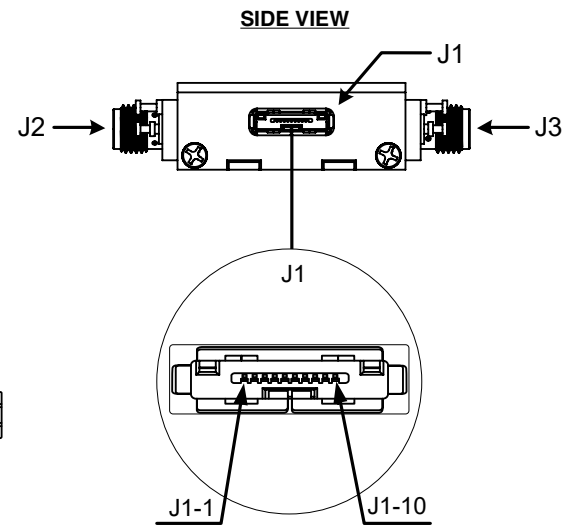
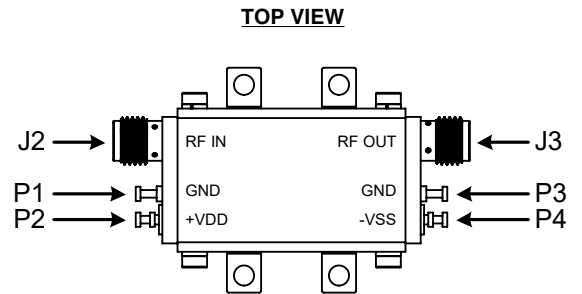

Cable Pin Description

J1-Pin Number	J4-Pin Number	Function	Description	Wire Color
J1-2	J4-18	GND	Ground connection	BLACK
J1-3	J4-4	LE	Latch Enable Input	GREEN
J1-5	J4-19	GND	Ground connection	BLUE
J1-7	J4-2	Clock	Serial Interface clock Input	RED
J1-8	J4-20	GND	Ground connection	ORANGE
J1-9	J4-3	Data	Serial Interface data Input	WHITE

Note: Other pins not connected. Cable shield connected to case ground.

NON-CATALOG

Digital Step Attenuator

ZX76-31R5-SN-S+

Typical Performance Curves

INSERTION LOSS (Ref)

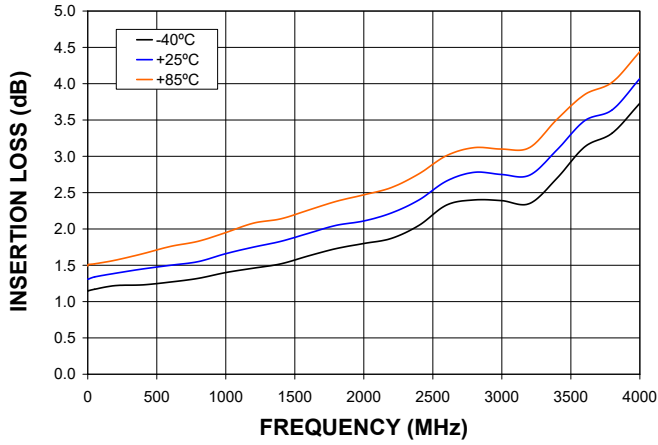

ATTENUATION (0.5 dB)

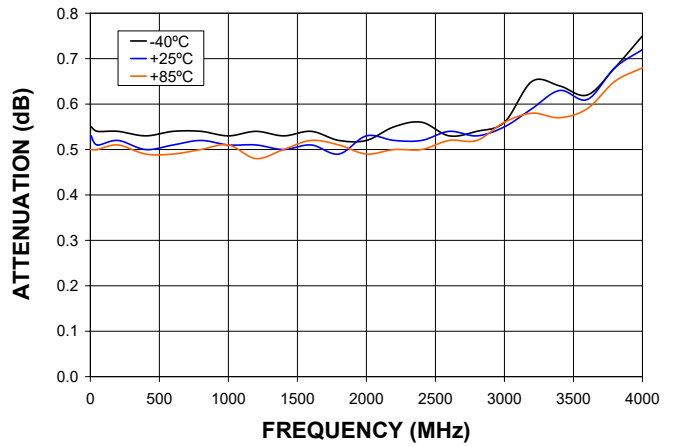

ATTENUATION (1 dB)

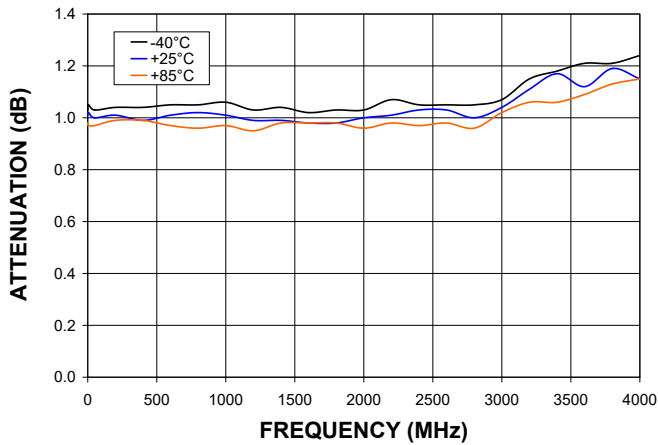

ATTENUATION (2 dB)

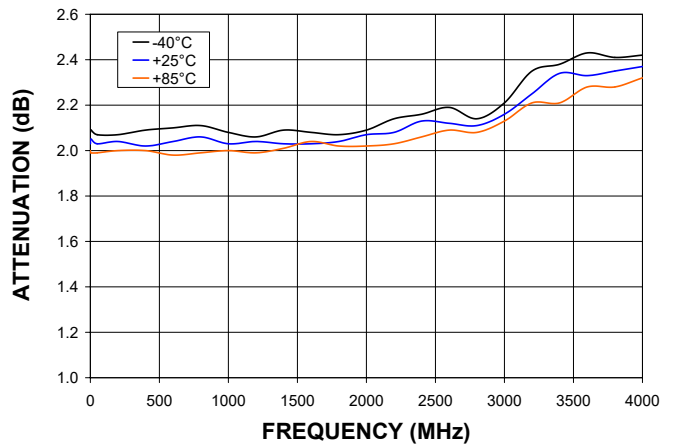

ATTENUATION (4 dB)

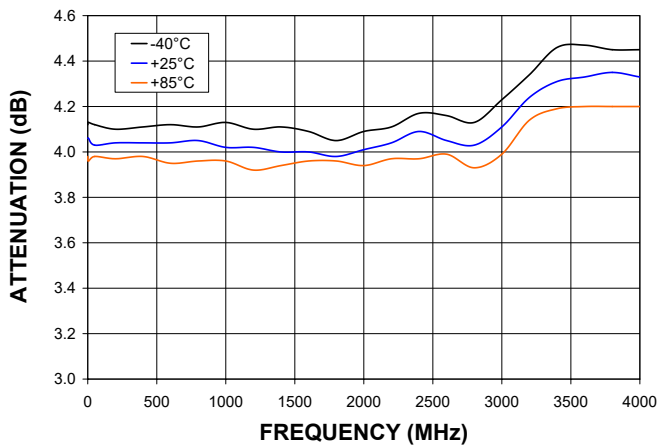

ATTENUATION (8 dB)

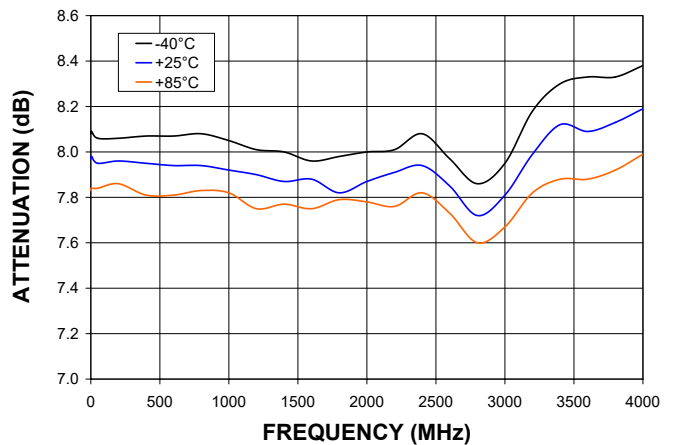

NON-CATALOG

Digital Step Attenuator

ZX76-31R5-SN-S+

Typical Performance Curves

ATTENUATION (16 dB)

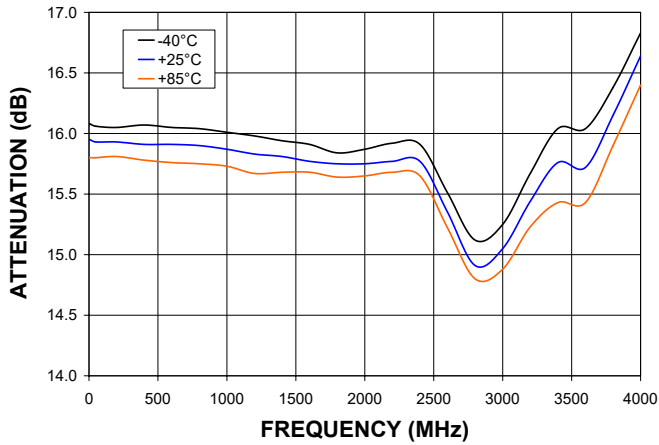

ATTENUATION (31.5 dB)

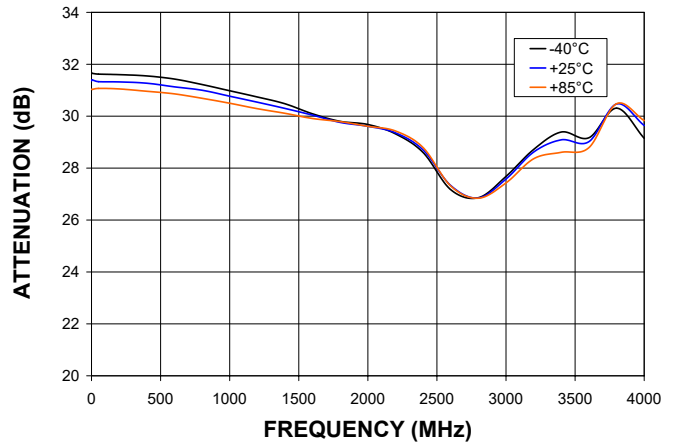

RETURN LOSS IN (Ref)

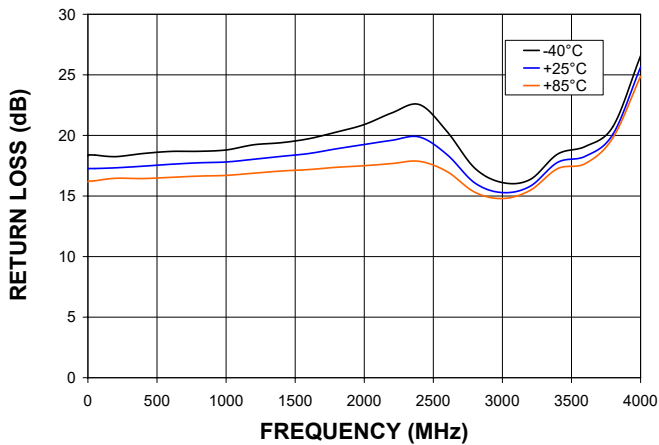

RETURN LOSS OUT (Ref)

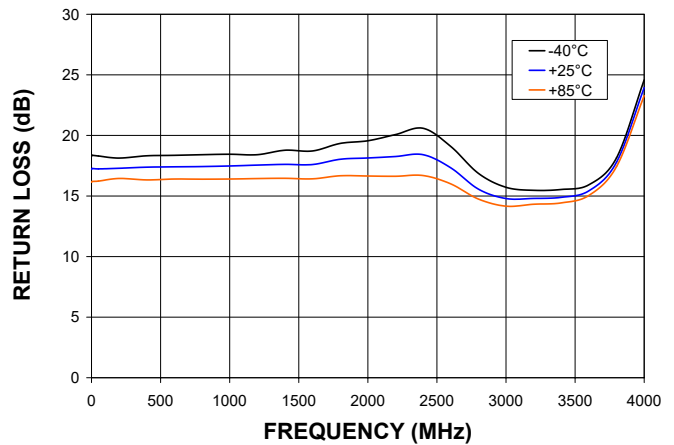

RETURN LOSS IN (Major Atten. Steps)
@ +25°C

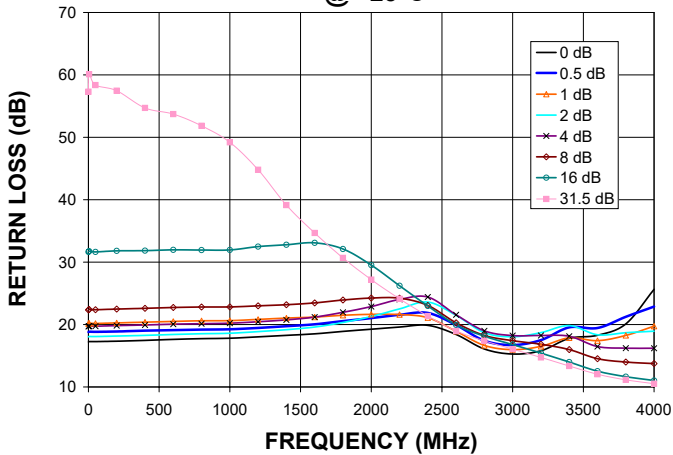

RETURN LOSS OUT (Major Atten. Steps)
@ +25°C

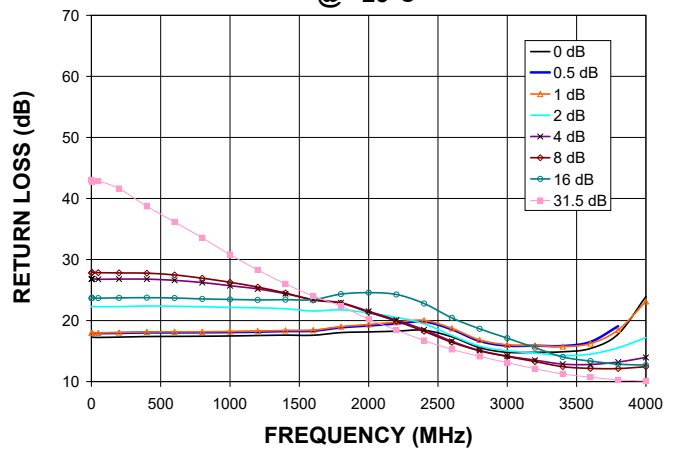

NON-CATALOG

Digital Step Attenuator

ZX76-31R5-SN-S+

Typical Performance Curves

IP3 (Major Atten. Steps) @ +25°C

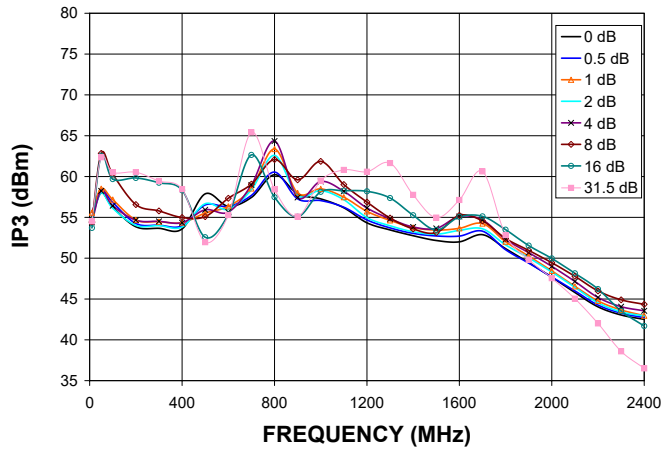

COMPRESSION @ INPUT POWER=+24dBm (Major Atten. Steps) @ +25°C

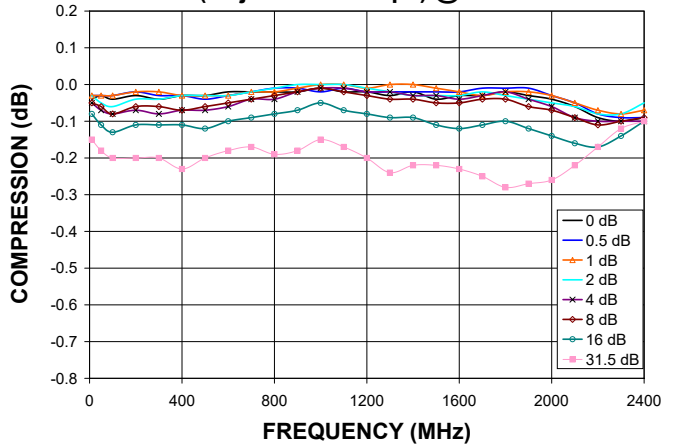

IP3 (Major Atten. Steps) @ -40°C

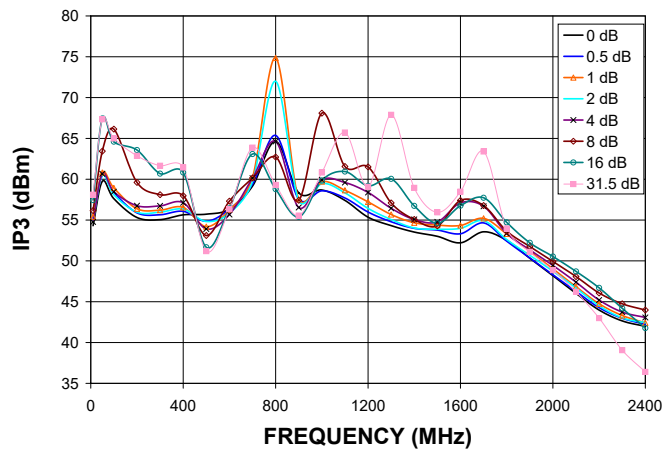

COMPRESSION @ INPUT POWER=+24dBm (Major Atten. Steps) @ -40°C

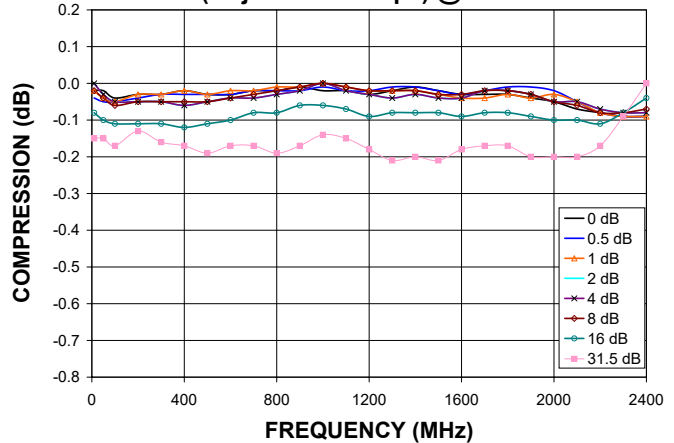

IP3 (Major Atten. Steps) @ +85°C

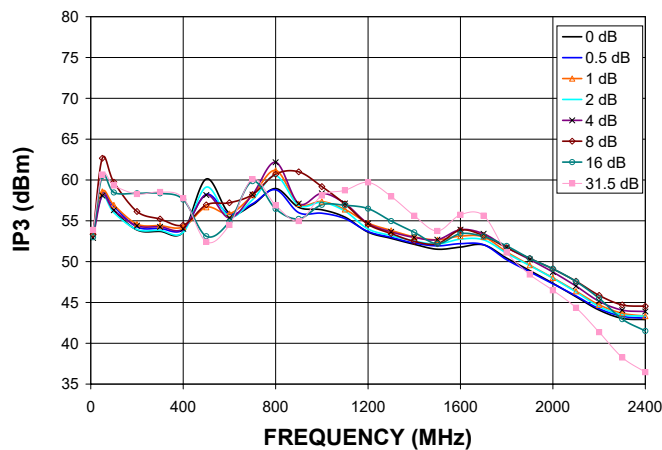

COMPRESSION @ INPUT POWER=+24dBm (Major Atten. Steps) @ +85°C

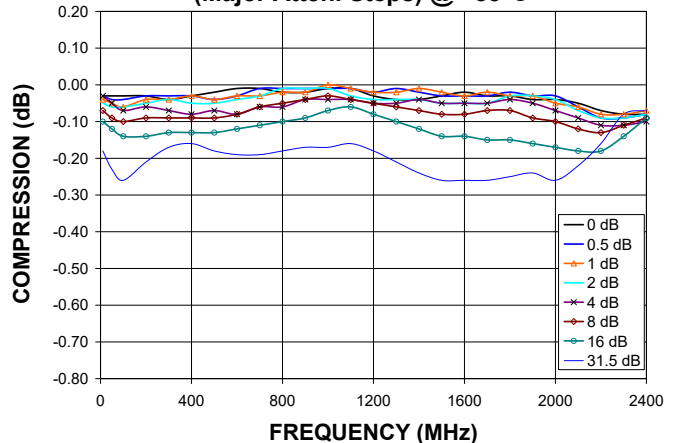

NON-CATALOG

Digital Step Attenuator

ZX76-31R5-SN-S+

Outline Drawing

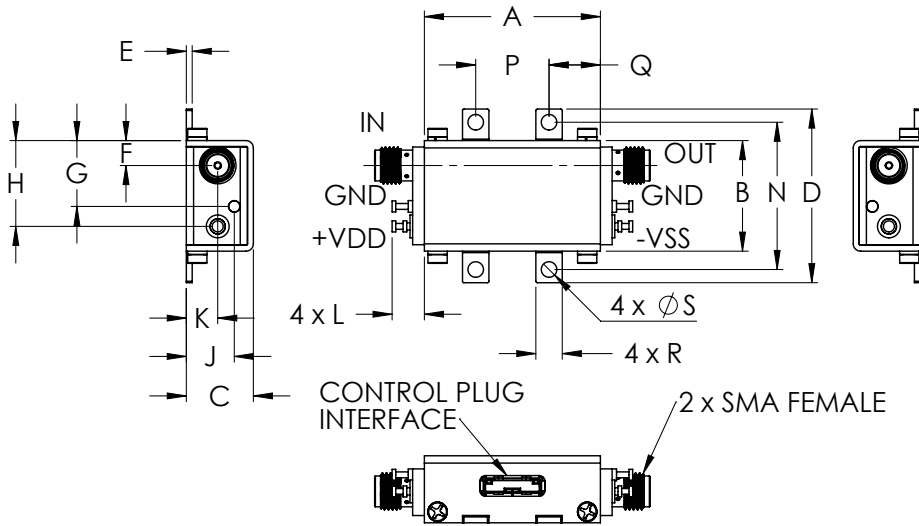

NOTE: When soldering the DC connections, caution must be used to avoid overheating the DC terminals. See Application Note [AN-40-10](#).

Outline Dimensions (inch/mm)

A	B	C	D	E	F	G	H	J	K	L	M	N	P	Q	R	S	WT. GRAMS
1.20	.75	.46	1.18	.04	.17	.45	.59	.33	.21	.22	-	1.00	.50	.35	.18	.106	35
30.48	19.15	11.61	30.07	1.02	4.32	11.40	14.86	8.31	5.44	5.59	-	25.40	12.70	8.89	4.57	2.69	

Recommended Mounting Hardware:

Use UNC#2 pan head screws with internal tooth lock washers for unit mounting.



Simplified Schematic

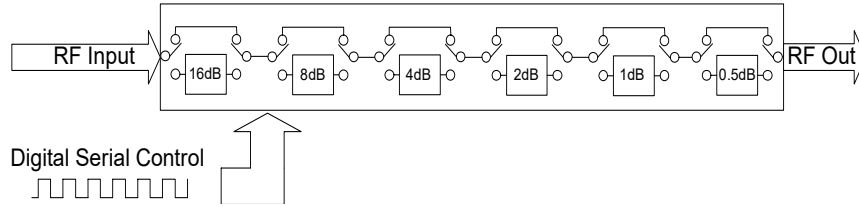

The ZX76-31R5-SN-S+ Serial interface consists of 6 control bits that select the desired attenuation state, as shown in Table 1: Truth Table

Attenuation State	C16	C8	C4	C2	C1	C0.5
Reference	0	0	0	0	0	0
0.5 (dB)	0	0	0	0	0	1
1 (dB)	0	0	0	0	1	0
2 (dB)	0	0	0	1	0	0
4 (dB)	0	0	1	0	0	0
8 (dB)	0	1	0	0	0	0
16 (dB)	1	0	0	0	0	0
31.5 (dB)	1	1	1	1	1	1

Note: Not all 64 possible combinations of C0.5 - C16 are shown in table

The serial interface is a 6-bit serial in, parallel-out shift register buffered by a transparent latch. It is controlled by three CMOS-compatible signals: Data, Clock, and Latch Enable (LE). The Data and Clock inputs allow data to be serially entered into the shift register, a process that is independent of the state of the LE input.

The LE input controls the latch. When LE is HIGH, the latch is transparent and the contents of the serial shift register control the attenuator. When LE is brought LOW, data in the shift register is latched.

The shift register should be loaded while LE is held LOW to prevent the attenuator value from changing as data is entered. The LE input should then be toggled HIGH and brought LOW again, latching the new data. The timing for this operation is defined by Figure 1 (Serial Interface Timing Diagram) and Table 2 (Serial Interface AC Characteristics).

Control cables for programming can be ordered separately. For details see page 10.

Figure 1: Serial Interface Timing Diagram

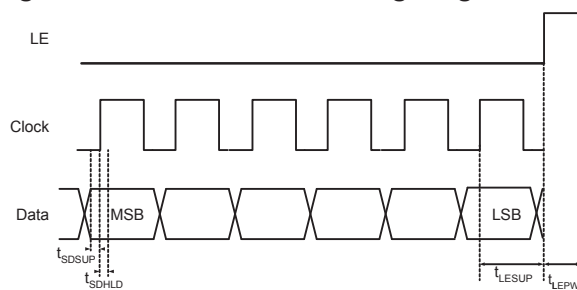

Symbol	Parameter	Min.	Max.	Units
f_{clk}	Serial data clock frequency (Note 1)		10	MHz
t_{clkH}	Serial clock HIGH time	30		ns
t_{clkL}	Serial clock LOW time	30		ns
t_{LESUP}	LE set-up time after last clock falling edge	10		ns
t_{LEPW}	LE minimum pulse width	30		ns
t_{SDSUP}	Serial data set-up time before clock rising edge	10		ns
t_{SDHLD}	Serial data hold time after clock falling edge	10		ns

Note 1. fclk verified during the functional pattern test. Serial programming sections of the functional pattern are clocked at 10MHz to verify fclk specification.

NON-CATALOG

Digital Step Attenuator

ZX76-31R5-SN-S+

The ZX76-31R5-SN-S+, uses a common 6-bit serial word format, as shown in Table 3: 6-Bit attenuator Serial Programming Register Map.

The first bit, the MSB, corresponds to the 16 dB Step and the last bit, the LSB, corresponds to the 0.5 dB step.

B5	B4	B3	B2	B1	B0
C16	C8	C4	C2	C1	C0.5

↑ MSB (first in)

↑ LSB (last in)

NON-CATALOG

Digital Step Attenuator

ZX76-31R5-SN-S+

Recommended Accessories

Two optional cable accessories with and without interface connector are available with ZX76-31R5-SN-S+, the ZX76-CS+ and ZX76-WS+. Cable length is 4.9 feet / 1.5 meters.

ZX76-CS+ shielded cable with interface 25 pin D-type connector J4 and supplied software are used to control the ZX76-31R5-SN-S+ digital attenuator from a computer, using LPT port.

ZX76-WS+ shielded cable without interface 25 pin D-type connector enables customer to use the ZX76-31R5-SN-S+ digital attenuator in his own application.

ZX76-CS+ Control Cable

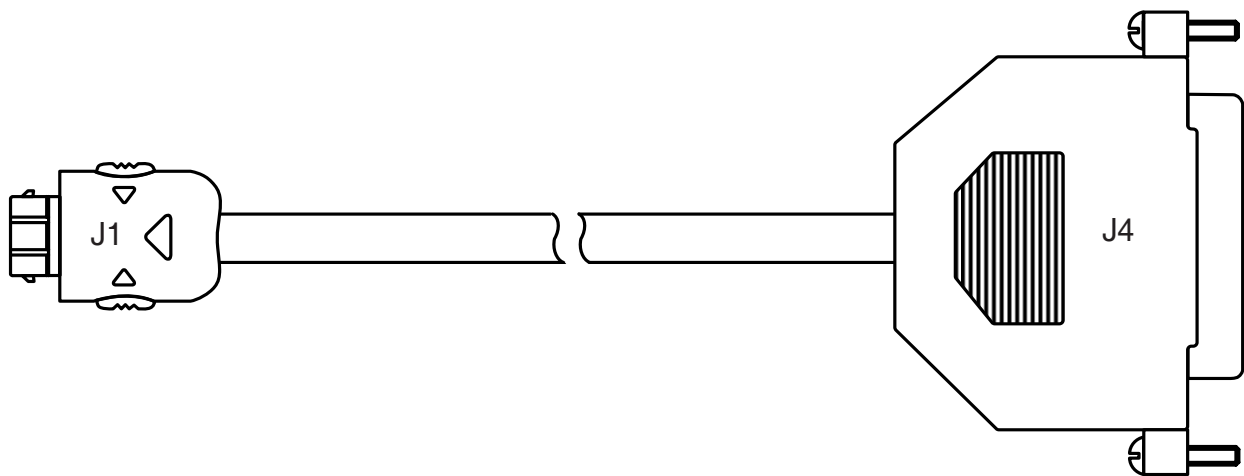

ZX76-CS+ wiring information

J1-Pin Number	J4-Pin Number	Function	Description	Wire Color
J1-2	J4-18	GND	Ground connection	BLACK
J1-3	J4-4	LE	Latch Enable Input	GREEN
J1-5	J4-19	GND	Ground connection	BLUE
J1-7	J4-2	Clock	Serial Interface clock Input	RED
J1-8	J4-20	GND	Ground connection	ORANGE
J1-9	J4-3	Data	Serial Interface data Input	WHITE

Note: Other pins not connected. Cable shield connected to case ground.

NON-CATALOG

Digital Step Attenuator

ZX76-31R5-SN-S+

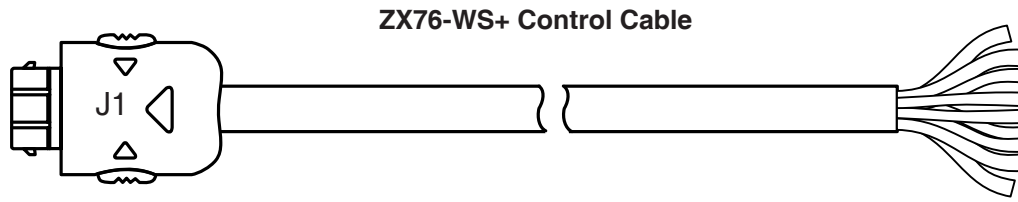

ZX76-WS+ wiring information

J1-Pin Number	Function	Description	Wire Color
J1-2	GND	Ground connection	BLACK
J1-3	LE	Latch Enable Input	GREEN
J1-5	GND	Ground connection	BLUE
J1-7	Clock	Serial Interface clock Input	RED
J1-8	GND	Ground connection	ORANGE
J1-9	Data	Serial Interface data Input	WHITE

Note: Other pins not connected. Cable shield connected to case ground.

Ordering Information

Model Number	Description
ZX76-31R5-SN-S+	Digital attenuator - Serial interface Dual Voltage (Negative and Positive)
ZX76-CS+	Cable accessory with interface connector
ZX76-WS+	Cable accessory without interface connector

Additional Notes

- Performance and quality attributes and conditions not expressly stated in this specification document are intended to be excluded and do not form a part of this specification document.
- Electrical specifications and performance data contained in this specification document are based on Mini-Circuit's applicable established test performance criteria and measurement instructions.
- The parts covered by this specification document are subject to Mini-Circuits standard limited warranty and terms and conditions (collectively, "Standard Terms"); Purchasers of this part are entitled to the rights and benefits contained therein. For a full statement of the Standard Terms and the exclusive rights and remedies thereunder, please visit Mini-Circuits' website at www.minicircuits.com/MCLStore/terms.jsp

