

Band-Master ATS[®]

The Advanced Termination System for Interconnect Cable Shielding

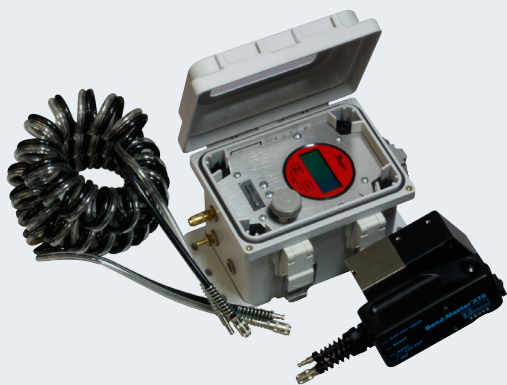

High-volume pneumatic tool
for bench use



Easy-to-use manual tools
with built-in calibration counter

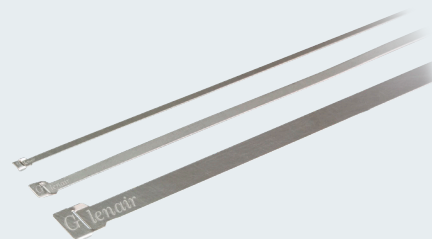

3 lengths and 3 widths of
EMI braid termination bands

SEPTEMBER 2020

Band-Master ATS®

Manual Tools and Bands

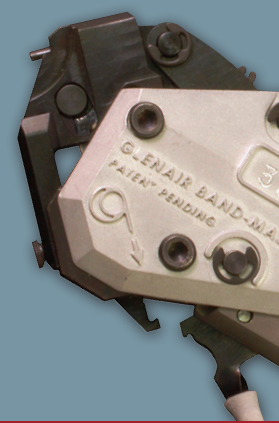

Standard Banding Tool



The 601-100 Band-Master ATS® Standard Tool with Counter for Standard Bands

Weighs approximately 1.30 lbs., and is designed for .240" width clamping bands in a tension range from 100 to 180 lbs. Calibrate at 150 lbs. ± 5 lbs. for most shield terminations. Tool and band should never be lubricated.

The 600-058 QPL Qualified (M81306/1A) Standard Banding Tool without Counter



Weighs 1.22 and is designed for .240" width clamping bands in a tension range from 100 to 180 lbs. Calibrate at 150 lbs. ± 5 lbs. for most shield terminations. Tool and band should never be lubricated (not shown).

Color-coded tool handle:



= Standard; Black

Bands	Band-Master ATS® Standard Band Selection					
	Length		Part Number		Fits Diameter	
	In.	mm.	Flat	Pre-Coiled	In.	mm.
Short Standard	9.0	228.6	601-005	601-006	1.0	25.4
Medium Standard	14.25	361.95	601-040	601-041	1.8	45.7
Long Standard	18.0	457.2	601-049	601-050	2.5	63.5

Cable Pull Strength for Band-Master™ ATS Standard Bands							
Name	Material Type	Band Width		Band Thickness		Calibration Setting	Cable Pull Strength
		In	mm	In	mm		
Standard	300 SS	0.240	6.10	.020	.51	150 ± 5 lbs	per AS85049/128

Bands	QPL Qualified Standard Band Selection					
	Length		Mil Spec Part Number		Fits Diameter	
	in.	mm.	Flat	Pre-Coiled	in.	mm.
Standard Band	14.25	361.95	M85049/128-3	M85049/128-4	1.8	45.7

Cable Pull Strength for Standard QPL Qualified Bands							
Name	Material Type	Band Width		Band Thickness		Calibration Setting	Cable Pull Strength
		In	mm	In	mm		
Standard	300 SS	0.240	6.10	.020	.51	150 ± 5 lbs	per AS85049/128

Knife and Blade and Replacement / Upgrade Kit	
Tool	Replacement Part Number(s)
601-100 Band-Master Standard	601-330 Knife and Blade Kit
600-058 QPL Qualified Tool	Contact Factory



Standard Bands

Short Flat 601-005

Short Precoiled 601-006

Standard Bands are precision constructed of 300 Series SST passivate IAW AMS 2700. Short Standard Bands are 9.00 inches (228.6) in length and designed for use with the Band-Master ATS® 60-100 manual banding tool or the 601-106 pneumatic banding tool. Bands should always be double wrapped and will accommodate diameters up to approximately 1.0 inches (25.4).

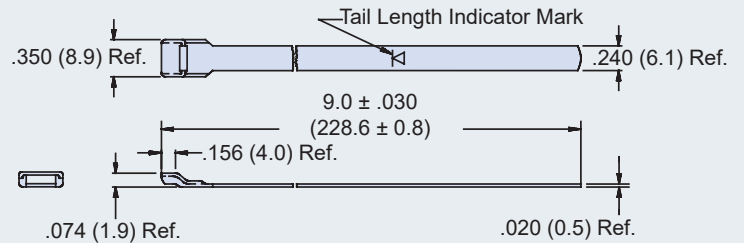

Medium Flat 601-040

Medium Precoiled 601-041

Standard bands are precision constructed of 300 Series SST passivate IAW AMS 2700. Medium Standard Bands are 14.25 inches (361.95) in length and designed for use with the Band-Master ATS® 601-100 manual banding tool or the 601-106 pneumatic banding tool. Bands should always be double wrapped and will accommodate diameters up to approximately 1.8 inches (45.7).

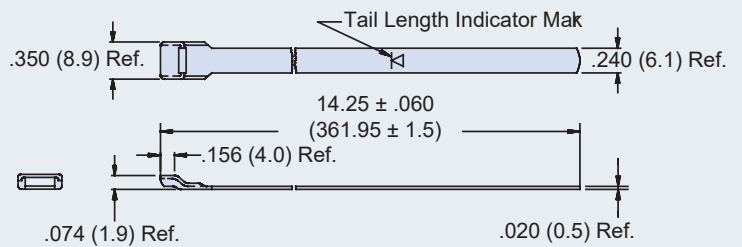

Long Flat 601-049

Long Precoiled 601-050

Standard bands are precision constructed of 300 Series SST passivate IAW AMS 2700. Long Standard Bands are 18.0 inches (457.2) in length and designed for use with the Band-Master ATS® 601-100 manual banding tool or the 601-106 pneumatic banding tool. Bands should always be double wrapped and will accommodate diameters up to approximately 2.5 inches (63.5).

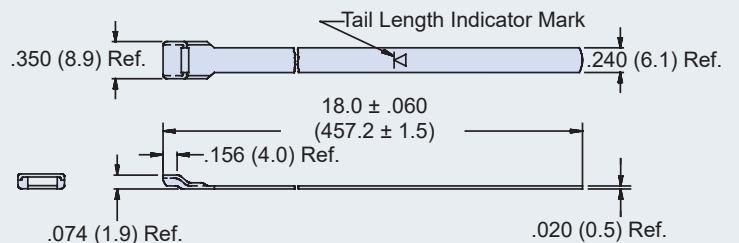

Band-Master ATS®

Manual Tools and Bands

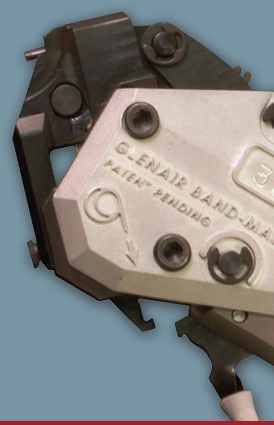

Slim Standard Banding Tool



Choose Glenair Slim Standard Bands for size and weight savings. Slim bands are 50% lighter with 50% lower profile than our standard bands, while maintaining similar performance.

The 601-109 Band-Master ATS® Slim Standard Tool with Counter for Slim Standard Bands

For use with slim standard flat and pre-coiled quarter inch wide clamping bands. Tension range is approximately 30 to 80 lbs. Calibrate at 100 lbs. ± 3 lbs of linear pull. Tool weighs 1.2 Lb. Tool and band should never be lubricated.

Color-coded tool handle



= Slim Standard; Orange

Band-Master ATS® Slim Standard Band Selection

Bands	Length		Part Number		Fits Diameter	
	in.	mm.	Flat	Pre-Coiled	in.	mm.
Short Slim Standard	9.0	228.6	601-570	601-571	.94	23.9
Medium Slim Standard	14.25	361.95	601-572	601-573	1.8	45.7

Cable Pull Strength for Band-Master ATS® Slim Standard Bands

Name	Material Type	Band Width		Band Thickness		Tool Setting	Cable Pull Strength
		In	mm	In	mm		
Slim Standard	300 Series SST	0.240	6.09	.010	.25	100 lbs. ± 3 lbs.	150 lbs.*

* Slim Bands are work hardened to achieve higher cable pull force

Knife and Blade and Replacement / Upgrade Kit

Tool	Replacement Part Number(s)
601-109 Band-Master Slim Standard	601-331 Knife and Blade Kit



Slim Standard Bands

Slim bands are better at conforming to irregular platform shapes (elliptical platforms) and individual braid buildup (pig tails)

Short Flat 601-570

Short Precoiled 601-571

Slim Standard Bands are 50% lighter and 50% lower-profile than Standard Bands. They are precision constructed of work hardened, 300 Series SST passivate IAW AMS 2700. Short Slim Bands are 9.00 inches (228.6) in length and designed for use with the 601-109 Band-Master ATS® hand banding tool or the 601-110 pneumatic tool. Bands should always be double wrapped and will accommodate diameters up to approximately .94 inches (23.9).

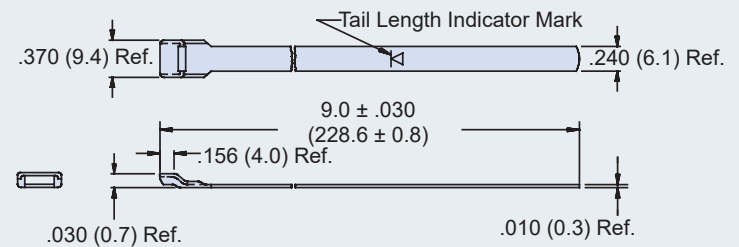

Medium Flat 601-572

Medium Precoiled 601-573

Slim Standard Bands are 50% lighter and 50% lower-profile than Standard Bands. They are precision constructed of work hardened, 300 Series SST passivate IAW AMS 2700. Medium Slim Bands are 14.25 inches (228.6) in length and designed for use with the 601-109 Band-Master ATS® hand banding tool or the 601-110 pneumatic tool. Bands should always be double wrapped and will accommodate diameters up to approximately 1.8 inches (45.7)

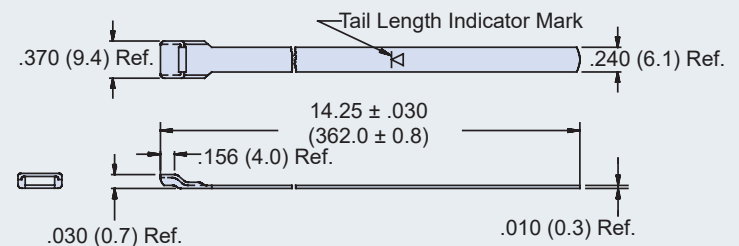

Band-Master ATS®

Manual Tools and Bands

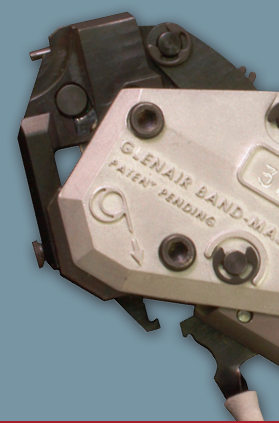

Micro Banding Tool



The 601-101 Band-Master ATS® Micro Tool with Counter for Micro Bands

Weighs approximately 1.20 lbs., and is designed for Micro .120" width clamping bands in a tension range from 50 to 85 lbs. Calibrate at 80 lbs \pm 3 lbs. for most shield terminations. Tool and band should never be lubricated.

The 600-061 QPL Qualified (M81306/1B) Micro Banding Tool without Counter



Weighs 1.11 and is designed for Micro .120" width clamping bands in a tension range from 60 to 85 lbs. Calibrate at 80 lbs \pm 5 lbs. Tool and band should never be lubricated.

Color-coded tool handle:



= Micro; Blue

Band-Master ATS® Micro Band Selection

Bands	Length		Part Number		Fits Diameter	
	in.	mm.	Flat	Pre-Coiled	in.	mm.
Short Micro	5.0	127.0	601-024	601-025	0.5	12.7
Medium Micro	8.125	206.38	601-060	601-061	.88	22.4
Long Micro	14.25	361.95	601-064	601-065	1.8	45.7

Cable Pull Strength for Band-Master ATS® Micro Bands

Name	Material Type	Band Width		Band Thickness		Calibration Setting	Cable Pull Strength
		In	mm	In	mm		
Micro	300 SS	0.120	3.05	.015	.38	80 \pm 5 lbs	per AS85049/128

QPL Qualified Micro Band Selection

Bands	Length		Part Number		Fits Diameter	
	in.	mm.	Flat	Pre-Coiled	in.	mm.
Standard Micro	8.125	206.38	M85049/128-7	M85049/128-8	.88	22.4

Cable Pull Strength for Micro QPL Qualified Bands

Name	Material Type	Band Width		Band Thickness		Calibration Setting	Cable Pull Strength
		In	mm	In	mm		
Micro	300 SS	0.120	3.05	.015	.38	80 \pm 5 lbs	per AS85049/128

Knife and Blade and Replacement / Upgrade Kit

Tool	Replacement Part Number(s)
601-101 Band-Master Micro	601-329 Knife and Blade Kit
600-061 QPL Qualified	Contact Factory



Micro Bands

Short Flat 601-024

Short Precoiled 601-025

Micro Bands are precision constructed of 300 Series SST passivate IAW AMS 2700. Short Micro Bands are 5.00 inches (127) in length and designed for use with the Band-Master™ 601-101 hand banding tool or the 601-107 pneumatic banding tool. Bands should always be double wrapped and will accommodate diameters up to approximately .5 inches (12.7).

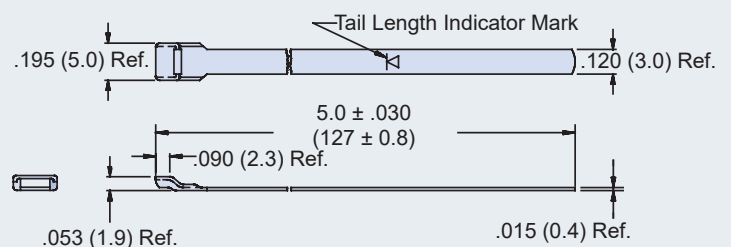

Medium Flat 601-060

Medium Precoiled 601-061

Micro Bands are precision constructed of 300 Series SST passivate IAW AMS 2700. Medium Micro Bands are 8.00 inches (203.2) in length and designed for use with the Band-Master™ 601-101 hand banding tool or the 601-107 pneumatic banding tool. Bands should always be double wrapped and will accommodate diameters up to approximately .88 inches (22.4).

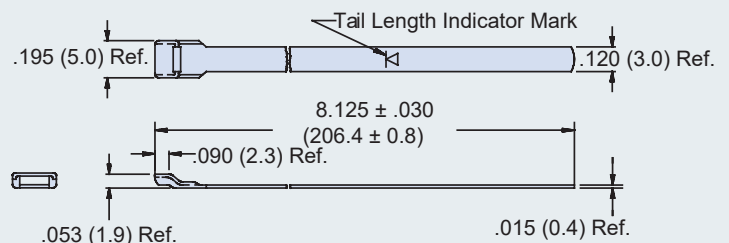

Long Flat 601-064

Long Precoiled 601-065

Micro Bands are precision constructed of 300 Series SST passivate IAW AMS 2700. Long Micro Bands are 14.00 inches (355.6) in length and designed for use with the Band-Master™ 601-101 hand banding tool or the 601-107 pneumatic banding tool. Bands should always be double wrapped and will accommodate diameters up to approximately 1.88 inches (47.8).

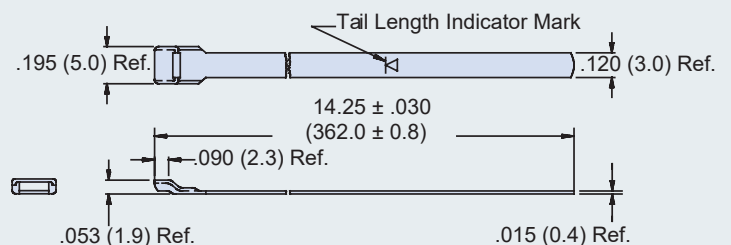

Band-Master ATS®

Manual Tools and Bands

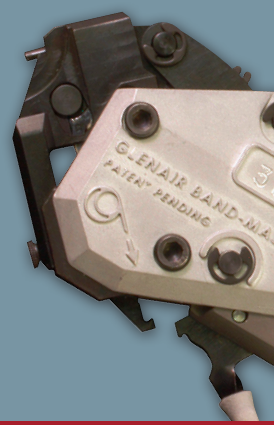

Micro Slim Banding Tool



The 601-122 Band-Master ATS® Micro Slim Tool with Counter for use with Micro Slim Bands

Weighs approximately 1.20 lbs., and is designed for Micro Slim .120 (3.05) width clamping bands in a tension range from 60 to 90 lbs. Double wrapped bands will accommodate up to .88 (22.35) inch diameter. Calibrate at 82 lbs \pm 3 lbs. for most shield terminations. Tool and band should never be lubricated.

Color-coded tool handle:

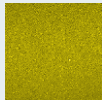

= Micro Slim; Yellow

Bands	Band-Master ATS® Micro Slim Band Selection					
	Length		Part Number		Fits Diameter	
	in.	mm.	Flat	Pre-Coiled	in.	mm.
Medium Micro Slim	8.125	206.38	601-600	601-601	.88	22.4
Long Micro Slim	14.25	361.95	601-602	601-603	1.80	45.7

Cable Pull Strength for Band-Master ATS® Micro Slim Bands							
Name	Material Type	Band Width		Band Thickness		Calibration Setting	Cable Pull Strength
		In	mm	In	mm		
Micro Slim	300 SST Work Hardened/Passivate	0.12w	3.05	.010	0.25	82 \pm 3 lbs	80 lvs

Knife and Blade and Replacement / Upgrade Kit	
Tool	Replacement Part Number(s)
601-122 Band-Master Micro Slim	601-328 Knife and Blade Kit



Micro Slim Bands

Slim bands are better at conforming to irregular platform shapes (elliptical platforms) and individual braid buildup (pig tails)

Medium Flat 601-600 Medium Precoiled 601-601

Micro Slim bands are precision constructed of 300 Series SST passivate IAW AMS 2700. Medium Micro Slim bands are 8.00 inches (203.2) in length and designed for use with the Band-Master™ 601-122 hand banding tool or the 601-123 pneumatic banding tool. Bands should always be double wrapped and will accommodate diameters up to approximately .88 inches (22.4).

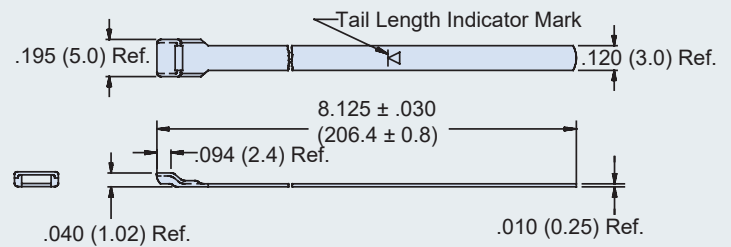

Long Flat 601-602 Long Precoiled 601-603

Micro Slim bands are precision constructed of 300 Series SST passivate IAW AMS 2700. Long Micro Slim Bands are 14.00 inches (355.6) in length and designed for use with the Band-Master™ 601-122 hand banding tool or the 601-123 pneumatic banding tool. Bands should always be double wrapped and will accommodate diameters up to approximately 1.88 inches (45.7).

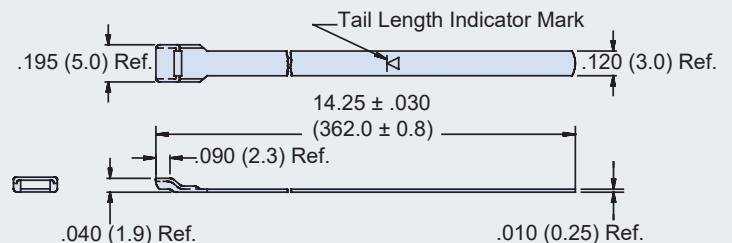

Band-Master ATS®

Manual Tools and Bands

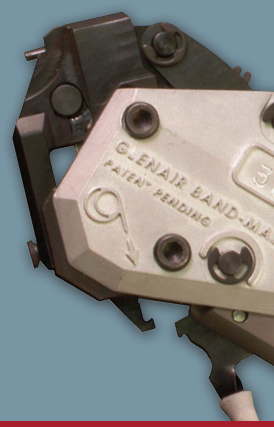

Nano Banding Tool



The 601-108 Band-Master ATS® Nano Tool with Counter for use with Nano Bands

Weighs 1.15 lbs., and is designed for use with Nano flat .075" width clamping bands in a tension range from 25 to 90 lbs. Calibrate at 50 lbs. \pm 3 lbs. for most shield terminations. Tool and band should never be lubricated.

Color-coded tool handle:



= Nano; Green

Bands	Band-Master ATS® Nano Band Selection					
	Length		Part Number		Fits Diameter	
	in.	mm.	Flat	Pre-Coiled	in.	mm.
Short Nano	6.0	152.4	601-500	601-501	.60	15.2
Medium Nano	9.0	228.6	601-504	601-505	.94	23.9
Long Nano	14.0	355.6	601-508	601-509	1.8	45.7

Cable Pull Strength for Band-Master ATS® Nano Bands							
Name	Material Type	Band Width		Band Thickness		Calibrated Setting	Cable Pull Strength
		In.	mm.	In.	mm.		
Nano	300 SS	0.075	1.91	.009	.23	50 \pm 3 lbs	50 lbs*

* Nano Bands are work hardened to achieve higher cable pull force

Knife and Blade and Replacement / Upgrade Kit	
Tool	Replacement Part Number(s)
601-108 Band-Master Micro Slim	601-332 Knife and Blade Kit



Nano Bands

Short Flat 601-500

Short Precoiled 601-501

Nano Bands are precision constructed of work hardened, 300 Series SST passivate IAW AMS 2700. Short Nano Bands are 6.00 inches (152.4) in length and designed for use with the 601-108 Band-Master ATS® hand banding tool or the 601-118 pneumatic banding tool. Bands should always be double wrapped and will accommodate diameters up to approximately .60 inches (15.2).

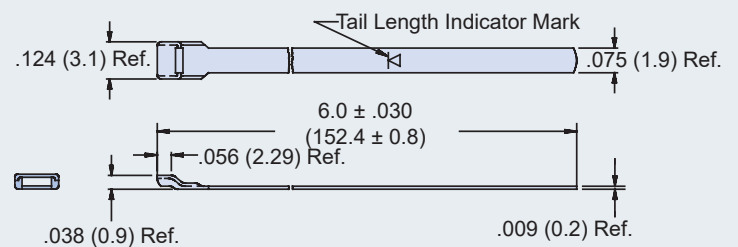

Medium Flat 601-504

Medium Precoiled 601-505

Nano Bands are precision constructed of work hardened, 300 Series SST passivate IAW AMS 2700. Medium Nano Bands are 9.00 inches (228.6) in length and designed for use with the 601-108 Band-Master ATS® hand banding tool or the 601-118 pneumatic banding tool. Bands should always be double wrapped and will accommodate diameters up to approximately .94 inches (23.9).

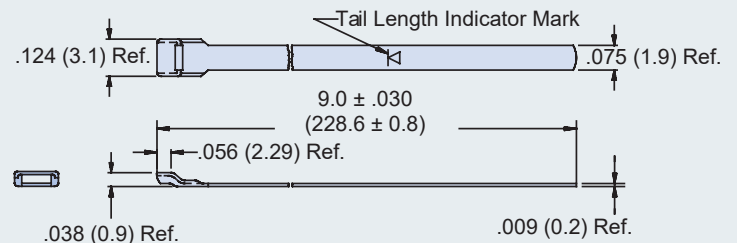

Long Flat 601-508

Long Precoiled 601-509

Nano Bands are precision constructed of work hardened, 300 Series SST passivate IAW AMS 2700. Long Nano Bands are 14.00 inches (361.95) in length and designed for use with the 601-108 Band-Master ATS® hand banding tool or the 601-118 pneumatic banding tool. Bands should always be double wrapped and will accommodate diameters up to approximately 1.8 inches (45.7).

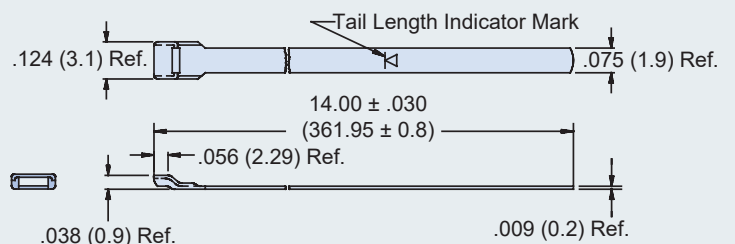

Band-Master ATS®

Calibration Tools, Kits and Accessories

Calibration Keys and Tension Gauges

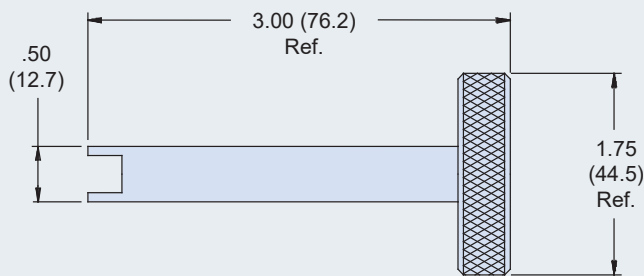

601-205 Calibration Key

The **601-205 Calibration Key** is designed for use with 600-058, 600-061, 601-211 and 601-212 manual banding tools. Material is black anodized aluminum alloy. One full turn clockwise will advance the tension range approximately 1.0 - 2.5 lbs, a counter-clockwise turn will decrease tension by the same amount.

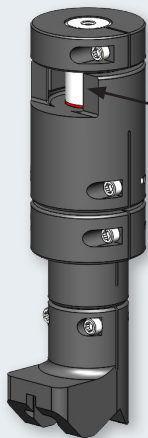

Verification inspection indicator window

Note: the band tool is within tolerance if no part of the stripes (above or below) appear in the verification inspection indicator window



601-211 and 601-212 Tension Gauge

The **601-211 (M81306/1C) and 601-212 (M81306/1D) Tension Gauge** is used to check and calibrate the manual tool to values noted on calibration sticker. Constructed of hardened steel.

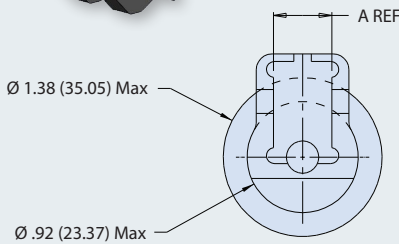

Above tolerance limit stripe (not visible when gauge is in the fixed position)

Below tolerance limit stripe (in view when gauge is in the fixed position)

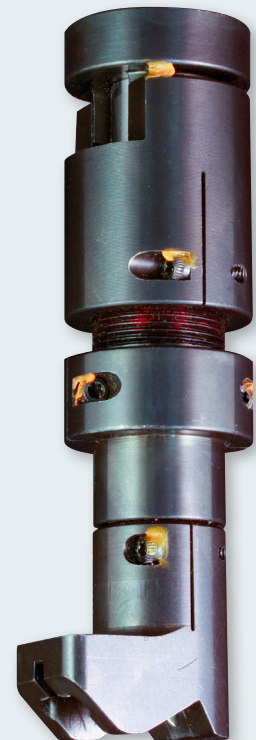

Part No.	SAE Part No. (Ref)	A +.015 (0.38) -.005 (0.13)	Used with Manual Tool P/N
601-211	M81306/1C	.460 (11.68)	Standard 601-100 • 600-058 (M81306/1-01 Kit)
601-212	M81306/1D	.360 (9.14)	Micro 601-101 • 600-061 (M81306/1-02 Kit)
601-205	M81306/1E	N/A	Both



Calibration Kits and Accessories

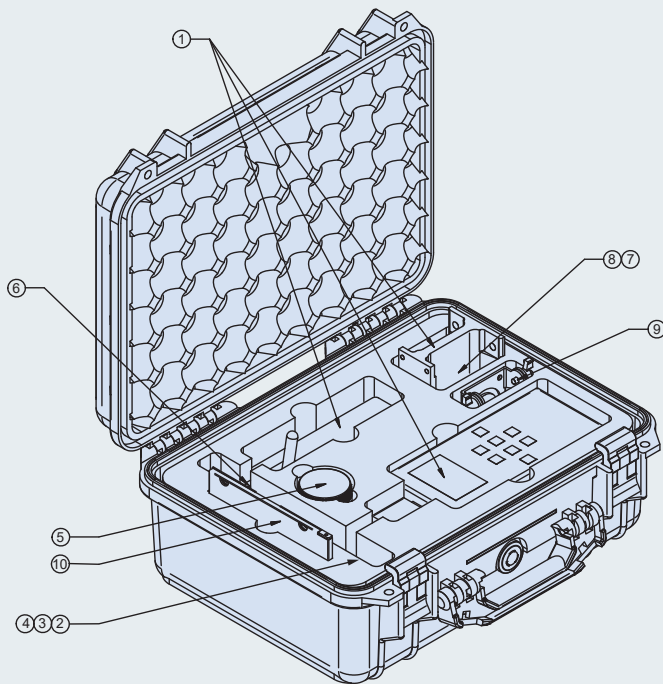

601-200 Calibration Kit For All Banding Tools

The 601-200 Calibration Kit includes:

1. 601-200-3 calibration device,
2. Fifty 601-203 Micro test bands,
3. Fifty 601-202 Standard test bands,
4. Fifty 601-217 Nano test bands,
5. 601-205 Calibration adjustment key,
6. 601-218 Tool adapter for 600-058
7. 601-219 Tool adapter for 600-067, 601-104
8. 601-220 Tool adapter for 601-101, 601-107, 601-122, and 601-123
9. 601-226 Tool adapter for 601-108 and 601-118

Range of the calibration device is 0 to 500 lbs, and accuracy is calibrated to ± 1 lbs. at factory. Digital readout in .1 lb. increments. Meter supplied with RS-232 serial communication port. Serial/USB adapter cable included.

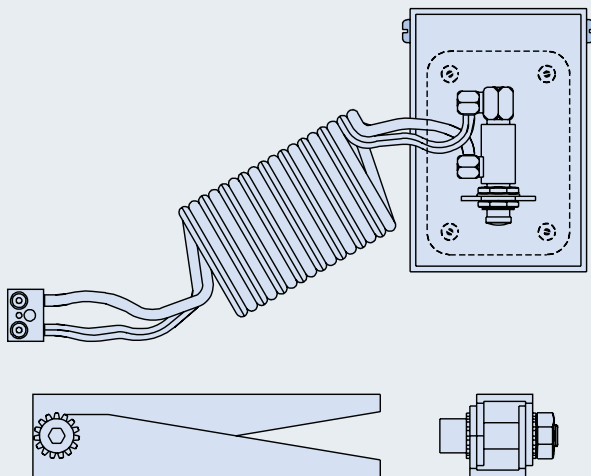

601-400 Foot Pedal Control for 601-106, 601-107, 601-110 and 601-118 Pneumatic Banding Tools

The 601-400 Foot Pedal Control frees both hands to help assure more accurate, reliable and faster shield terminations.

Band-Master ATS®

Calibration Tools, Kits and Accessories

Tool Balancer

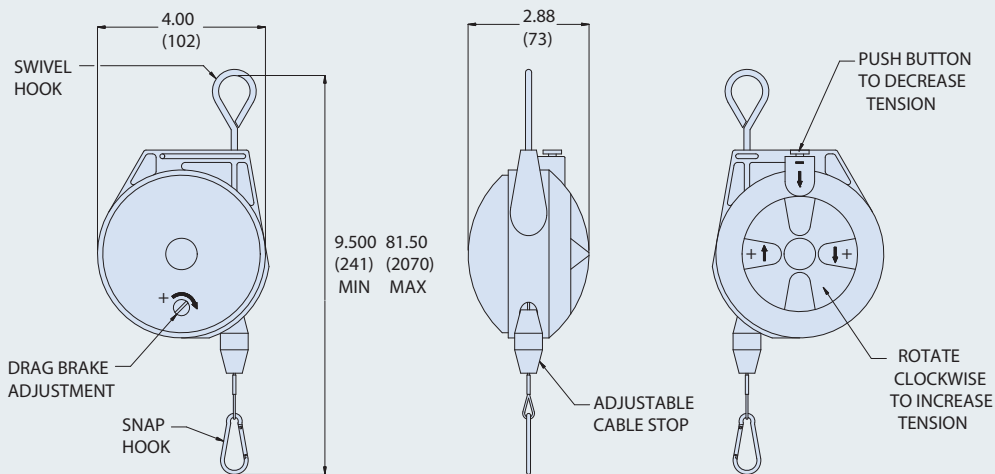

601-401 Tool Balancer

The 601-401 Tool Balancer for use with pneumatic banding tools 601-104, 601-105, 601-106, 601-107. Load capacity, 1.5 (0.5 kg) to 3.0 Lbs (1.4 kg). Cable length, 6 ft (1.8 m). Reel weight, 1.3 Lbs (0.6 Kg). Pneumatic tool head weight, 2.52 Lbs (1.14 Kg)

Pneumatic Banding Tools

See tool description on following page

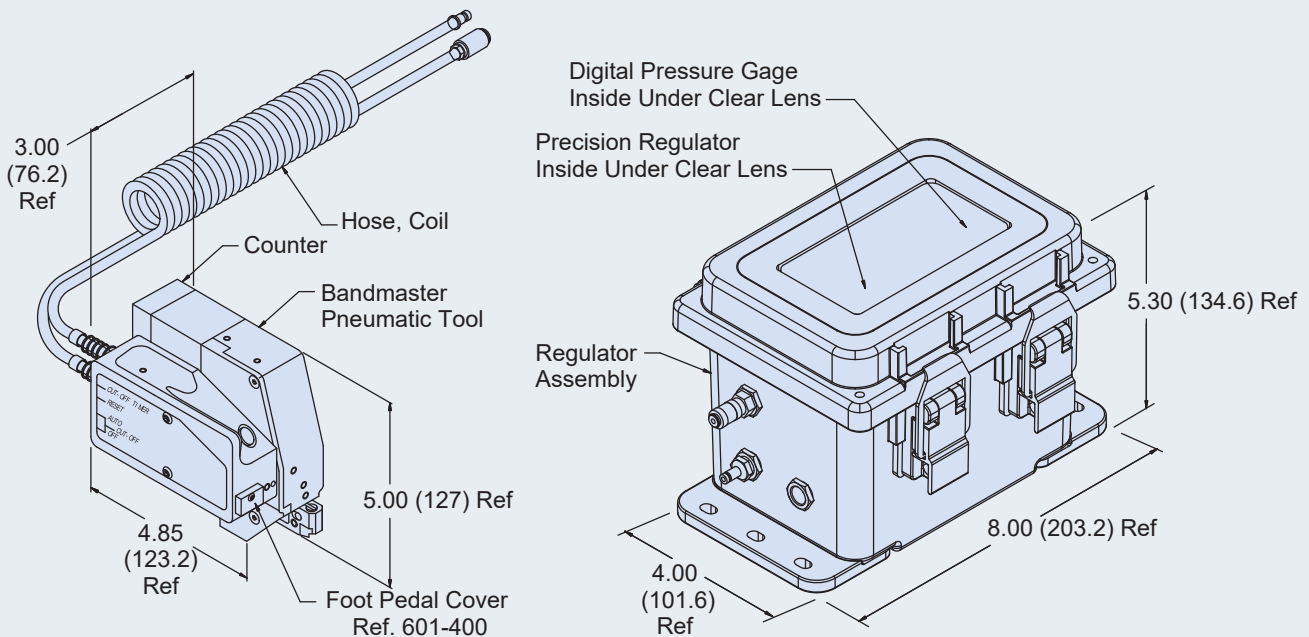



Pneumatic Banding Tools

High-Volume Pneumatic Bench-Mount Units and Calibration Kits Available for Standard, Micro, Nano and Slim Band Termination Systems

601-106 Standard Pneumatic Banding Tool with Counter

The 601-106 Standard Pneumatic Banding Tool accommodates 601-005, 601-006, 601-040, 601-041, 601-049, 601-050, 601-052 and 601-054 standard quarter inch bands in a tension range of from 100-180 lbs. Calibrate at 150 ± 5 lbs for most shield terminations. Weight of the tool is 2.52 lbs (1.14 Kg); the control box weighs 3.51 lbs (1.59 Kg). Includes 601-400 foot pedal.

601-107 Micro Pneumatic Banding Tool with Counter

The 601-107 Micro Pneumatic Banding Tool accommodates 601-024, 601-025, 601-060, 601-061, 601-064, 601-065, 600-057, and 600-059 eighth inch Micro Bands in a tension range of from 60 to 90 lbs. Calibrate at 80 ± 5 lbs for most shield terminations. Weight of the tool is 2.52 lbs (1.14 Kg); the control box weighs 3.51 lbs (1.59 Kg). Includes 601-400 foot pedal.

601-110 Slim Standard Pneumatic Banding Tool with Counter

The 601-110 Slim Standard Pneumatic Banding Tool accommodates 601-024, 601-025, 600-057 and 600-059 quarter inch Slim Standard bands. Approximate tension range of 30-80 lbs. Calibrate at 100 ± 3 lbs of linear pull. Weight of the tool is 2.52 lbs (1.14 Kg); the control box weighs 3.51 lbs (1.59 Kg). Includes 601-400 foot pedal.

601-123 Micro Slim Pneumatic Banding Tool with Counter

The 601-123 Micro Slim Pneumatic Banding Tool accommodates 601-600, 601-601, 601-602, 601-603 Micro Slim bands. Approximate tension range of 60-90 lbs. Calibrate at 82 ± 3 lbs for most shield terminations. Tool Weight is 2.52 lbs (1.14 Kg); the control box weighs 3.51 lbs (1.59 Kg). Includes 601-400 foot pedal.

Pneumatic Banding Tool Replacement Blade and Knife

Band-Master Pneumatic Tool	Knife and Blade Kit P/N
601-106 Standard Pneumatic	601-330
601-110 Slim Standard Pneumatic	601-331
601-107 Micro Pneumatic	601-329
601-123 Micro Slim Pneumatic	601-328
601-118 Nano Pneumatic	601-332

601-118 Nano Pneumatic Banding Tool with Counter

The 601-118 Nano Pneumatic Banding Tool accommodates 601-570, 601-571, 601-572, and 601-573 Nano bands. Approximate tension range of 25-90 lbs. Calibrate at 50 ± 3 lbs of linear pull. Weight of the tool is 2.52 lbs (1.14 Kg); the control box weighs 3.51 lbs (1.59 Kg). Includes 601-400 foot pedal.

Band-MasterATS®

Shield Termination Assembly Process

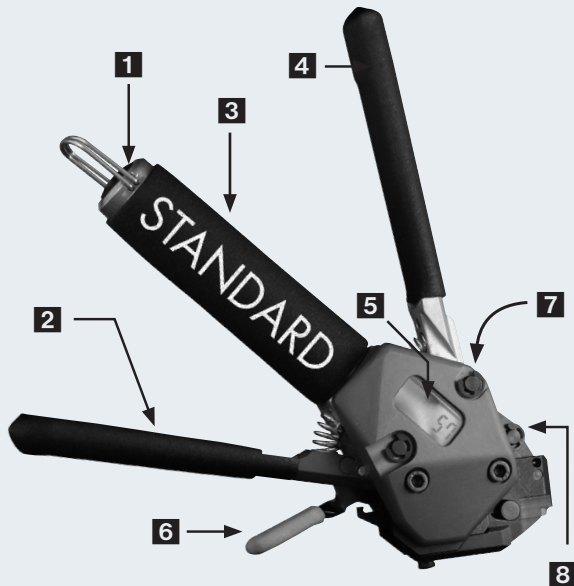

1 Calibration Access Plug

2 Tensioning Lever:

Squeeze with short gentle strokes to tighten band to the proper tension. Lever will lock to **3 Handle** with final full stroke.

4 Cut-Off Lever:

Squeeze to lock band buckle and trim excess band material.

5 Cycle Counter

6 Band Insertion and Release Lever:

Depress lever to insert or release band from tool.

7 Serial Number

8 Tension Release Lever

NOTES:

1. Use only genuine Band-Master ATS® bands. Other manufacturer's bands may damage tool.
2. Use only .240" wide bands with 601-100 tool and .120" wide bands with 601-101 tool.

Video Training Series At:

<http://www.glenair.com/bandmaster/index.htm>

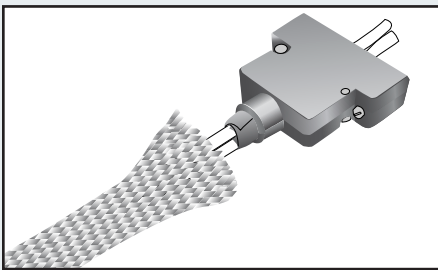

Step 1

Prepare Cable Braid for termination process

NOTE: Complete banding on an unfixtured cable assembly. Terminating a band to a clamped or fixtured cable will affect the applied forces and interfere with the cut-off operation. The cut-off operation causes a rotation of the band termination in order to lock the band.

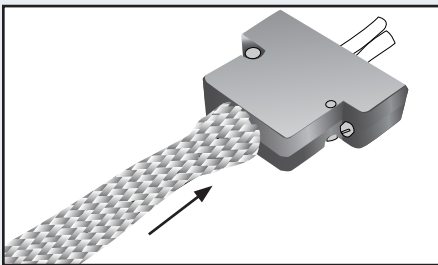

Step 2

Push braid forward over banding platform. Milk braid as required to remove slack and ensure a snug fit around the shield termination area.

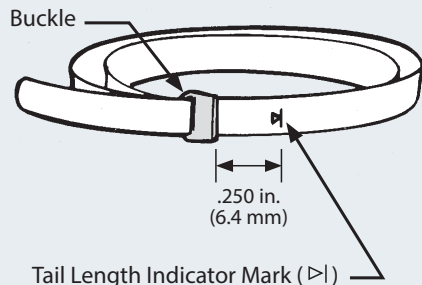

Step 3

Double-wrap the band prior to use:

NOTE: Due to connector/adaptor circumference, it may be necessary to double-coil the band in place around the cable or termination area.

A. Loop/insert the leading edge of band through the buckle slot twice. (Bands *must* be double-wrapped.)

B. Tighten the coil until the indicator mark (>|) is approximately .250 inches (6.4) shy of the buckle slot (see illustration at left). This will ensure sufficient band tail length for insertion into tool.

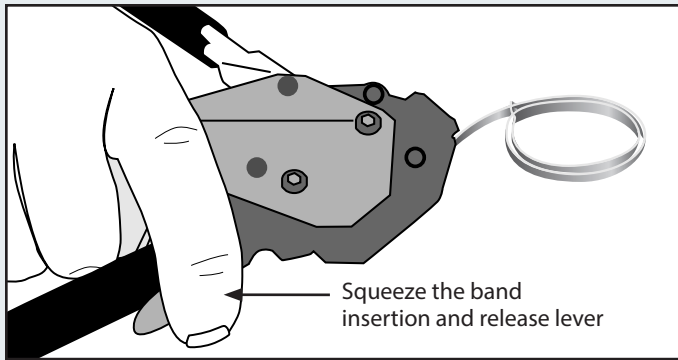

Step 4

Depress the band insertion and release lever (6), and insert the working end of the band into the front end opening of the tool, with the loop positioned outward as shown.

Step 5

The band termination area on all backshells is wider than the band. Position the band near the rear lip of the banding platform, allowing room for the buckle. For elliptical cable entries position the buckle off center of the peak of the circle. Failure to follow these guidelines will result in poor performance.

Position the band near the rear lip leaving room for buckle.

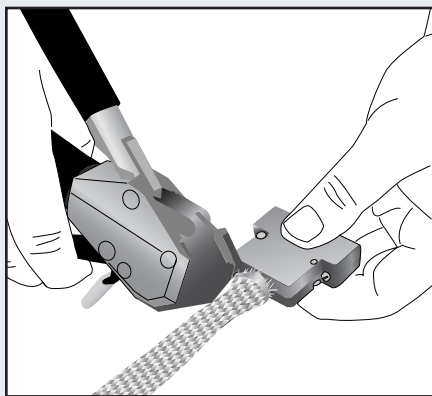
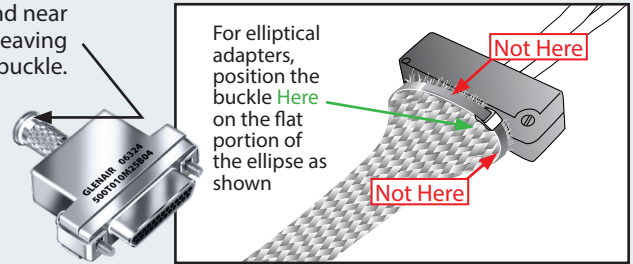

Step 6

Contract the band with the tensioning lever (2) using short, even strokes. As the band contracts firmly on the termination area, pull a full stroke to lock the lever against the main tool handle which will indicate the band is compressed to the proper tension.

NOTE: Overly rapid tightening of the band may result in uneven compression. If alignment of the band and shield is unsatisfactory, tension can be relaxed by pulling up on the tensioning lever (2) and then pushing the tension release lever (8) forward. Make adjustments as necessary and finish tightening with tensioning lever (2) as described above.

Step 7

Complete the clamping process by depressing the cut-off lever (4), allowing band and cable to rotate slightly. Pull up the release lever (6) to remove excess band for disposal.

NOTE: Always band on an unfixtured connector/cable assembly.

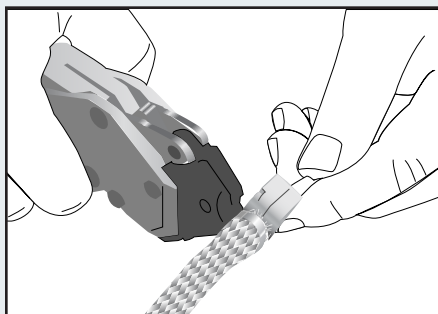

Step 8

Trim away excess braid from the forward groove, particularly if a shrink boot is to be applied to the assembly.

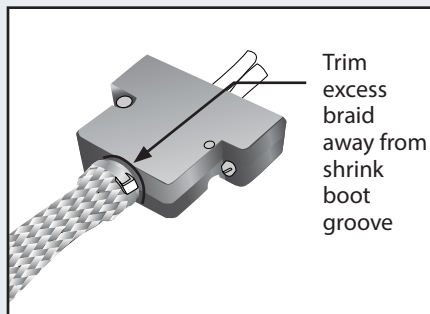

Step 9

Visually inspect shield termination for problems.

NOTE: Band can be removed by lifting the buckle with a screwdriver or diagonal cutters.

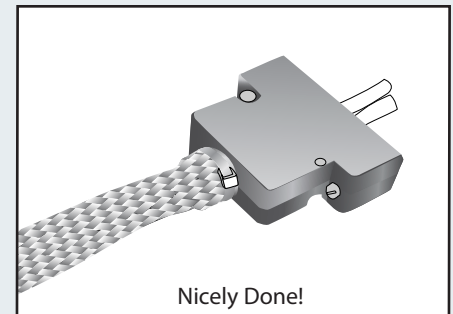

Band-MasterATS®

Band Overview and Performance Matrix

Criteria	Standard	Slim Standard	Micro	Micro Slim	Nano
Material	304 SS	304 SS	304 SS	304 SS	304 SS
Part Numbers (Flat)	601-005 (9"), 601-040 (14"), 601-049 (18")	601-570 (9"), 601-572 (14")	601-024 (5"), 601-060 (8"), 601-064 (14")	601-600 (8"), 601-602 (14")	601-500 (6"), 601-504 (9"), 601-508 (14")
Part Numbers (precoiled)	601-006 (9"), 601-041 (14"), 601-050 (18")	601-571 (9"), 601-573 (14")	601-025 (5"), 601-061 (8"), 601-065 (14")	601-601 (8"), 601-603 (14")	601-501 (6"), 601-505 (9"), 601-509 (14")
Lengths (inch)	18", 14" and 9"	14" and 9"	14", 8" and 5"	14" and 8"	14", 9" and 6"
Fits Diameters (inch)	.30" to 2.5"	.30" to 1.8"	.15" to 1.8"	.15" to 1.9"	.08" to 1.8"
Width (inch)	.24"	.24"	.12"	.12"	.075"
Thickness (Inch)	.02"	.01"	.015"	.01"	.01"
Weight before installation (grams)	14" is 9.06 g	14" is 4.46 g	8" is 1.76 g	8" is 1.16 g	9" is .84 g
Tooling Information					
Hand Tool Part Number	601-100	601-109	601-101	601-122	601-108
Pneumatic Tool Part Number	601-106	601-110	601-107	601-123	601-118
Recommended Tool Setting	150 ±5 lbs.	100 ± 3 lbs.	80 ±5 lbs.	82 ± 3 lbs.	50 ±3 lbs.
Performance Data					
Termination Resistance (mΩ)	0.082	0.083	0.087	0.080	0.155
Termination Construction	Ni/Al backshell Size 25, Tin Copper Braid	Ni/Al backshell Size 25, Tin Copper Braid	Ni/Al backshell Size 15, Tin Copper Braid	Ni/Al backshell Size 15, Tin Copper Braid	Ni/Al backshell Size 16, Tin Copper Braid
Avg. Single Junction Resistance (mΩ)	0.42	0.532	0.382	0.235	0.613
Cable Pull Out (pounds)	160 lbs.	150 lbs.	80 lbs.	80 lbs.	100 lbs.
Clamping Tension (pounds)	100 to 180 lbs.	50 to 100 lbs.	50 to 85 lbs.	80 to 86 lbs.	20 to 50 lbs.
Random Vibration	46grms at +175°C 8 hrs each axis, EIA-364-28E cond. V, letter K	46grms at +175°C 8 hrs each axis, EIA-364-28E cond. V, letter K	46grms at +175°C 8 hrs each axis, EIA-364-28E cond. V, letter K	46grms at +175°C 8 hrs each axis, EIA-364-28E cond. V, letter K	46grms at +175°C 8 hrs each axis, EIA-364-28E cond. V, letter K
Thermal Shock	-65°C to +200°C 5 cycles	-65°C to +200°C 5 cycles	-65°C to +200°C 5 cycles	-65°C to +200°C 5 cycles	-65°C to +200°C 5 cycles
Temperature Life	1,000 hrs at +200°C	1,000 hrs at +200°C	1,000 hrs at +200°C	1,000 hrs at +200°C	1,000 hrs at +200°C
Associated Test Report (Available Upon Request)	Test Report GT-14-75	Test Report GT-14-75	Test Report NTS 978-7382	Test Report GT-20-258	Test Report NTS PR021798
Mil-Spec (85049)	Yes	No	Yes	No	No

HEAVY-DUTY

Interconnect Assembly Tools

The right tool for every interconnect
assembly requirement



**BandMaster™ ATS EMI/RFI
Shield Termination System**



**Backshell-to-Connector
Assembly Tools**

Glenair offers its connector and connector accessory customers every convenience in the provision of contact termination, shield termination, and backshell-to-connector assembly tooling. We are also proud to offer branded solutions from other well-known tool manufacturers such as Daniels (DMC) crimp tools. From pneumatic Earth-Bond tooling for the rail industry, to fiber optic termination and test equipment, Glenair is your most knowledgeable and reliable source for special-purpose interconnect assembly tooling.



Out of This World
**INTERCONNECT
SOLUTIONS**

Glenair, Inc.

1211 Air Way • Glendale, California • 91201-2497

Telephone: 818-247-6000 • Fax: 818-500-9912 • sales@glenair.com

www.glenair.com

**Glenair Power
Products Group**

860 N. Main Street Extension
Wallingford, CT
06492

Telephone:
203-741-1115
Facsimile:
203-741-0053
sales@glenair.com

Glenair UK Ltd

40 Lower Oakham Way
Oakham Business Park
P.O. Box 37, Mansfield
Notts, NG18 5BY England

Telephone:
+44-1623-638100
Facsimile:
+44-1623-638111
sales@glenair.co.uk

Glenair Microway Systems

7000 North Lawndale Avenue
Lincolnwood, IL
60712

Telephone:
847-679-8833
Facsimile:
847-679-8849

Glenair Nordic AB

Gustav III : S Boulevard 46
SE-169 27 Solna
Sweden

Telephone:
+46-8-50550000
sales@glenair.se

Glenair Electric GmbH

Schaberweg 28
61348 Bad Homburg
Germany

Telephone:
06172 / 68 16 0
Facsimile:
06172 / 68 16 90
info@glenair.de

Glenair Iberica

C/ La Vega, 16
45612 Velada
Spain

Telephone:
+34-925-89-29-88
Facsimile:
+34-925-89-29-87
sales@glenair.es

Glenair Italia S.p.A.

Via Del Lavoro, 7
40057 Quarto Inferiore –
Granarolo dell'Emilia
Bologna, Italy

Telephone:
+39-051-782811
Facsimile:
+39-051-782259
info@glenair.it

Glenair France SARL

7, Avenue Parmentier
Immeuble Central Parc #2
31200 Toulouse
France

Telephone:
+33-5-34-40-97-40
Facsimile:
+33-5-61-47-86-10
sales@glenair.fr

Glenair Korea

B-1304 Gunpo IT Valley
148 Gosan-Ro, Gunpo-Si
Kyunggi-Do, Korea
435-733

Telephone:
+82-31-8068-1090
Facsimile:
+82-31-8068-1092
sales@glenair.kr