



### POWER SUPPLY

- AC 100-120V / 200-240V Auto-Select Input
- Cost Optimized without Compromising Quality or Reliability.
- Width only 39mm
- Efficiency up to 92.3%
- Full Power Between -10°C and +55°C
- DC-OK Relay Contact Included
- 3 Year Warranty

### GENERAL DESCRIPTION

These PIANO series units are extraordinarily compact, industrial grade power supplies that focus on the essential features needed in today's industrial applications. The excellent cost/performance ratio presents many new and exciting opportunities without compromising quality or reliability.

The mechanically robust housing is made of a high-grade, reinforced molded material, which permits the units to be used in surrounding temperatures up to 70°C.

The unit is equipped with a auto-select input voltage stage, which makes the unit suitable for global use.

The addition of a DC-OK signal makes the unit suitable for many industry applications such as: process, automation and many other critical applications where preventive function monitoring can help to avoid long downtimes.

### SHORT-FORM DATA

Output voltage	DC 24V	
	24 - 28Vdc	Adjustment range
Output	for AC 110-120 / 220-240V mains:	
	5.0 - 4.3A	at 24-28V, <55°C
	3.1 - 2.7A	at 24-28V, <70°C
	for AC 100 / 200V mains:	
	5.0 - 4.3A	at 24-28V, <50°C
	2.5 - 2.1A	at 24-28V, <70°C
Output ripple	< 100mVpp	20Hz to 20MHz
AC Input voltage	AC 100-120V / 200-240V	±10% Auto-Select
Mains frequency	50-60Hz	±6%
AC Input current	1.72A / 1.05A	at 120/ 230Vac
Power factor	0.64 / 0.54	at 120/ 230Vac
AC Inrush current	22A / 33A peak	at 120/ 230Vac, 40°C
Efficiency	91.2% / 92.3%	at 120/ 230Vac
Losses	11.6W / 10.0W	at 120/ 230Vac
Temp. range	-10°C to +70°C	operational
Derating	3W/°C	+55 to +70°C*)
Hold-up time	51ms / 50ms	at 120/ 230Vac
Dimensions	39x124x124mm	WxHxD
Weight	370g / 0.81lb	

\*) +50 to +70°C for AC 100V / 200V mains

### ORDER NUMBERS

Power Supply	<b>PIC120.241D</b>	24-28V Unit
Accessory	YR2.DIODE UF20.241	Redundancy module Buffer Module

### MARKINGS





### INDEX

	Page		Page
1. Intended Use .....	3	19. Approvals .....	16
2. Installation Requirements.....	3	20. RoHS, REACH and Other Fulfilled Standards ..	16
3. AC-Input.....	4	21. Physical Dimensions and Weight .....	17
4. DC-Input.....	5	22. Accessory.....	18
5. Input Inrush Current .....	5	22.1. UF20.241 Buffer module .....	18
6. Output .....	6	22.2. YR2.DIODE Redundancy Module.....	18
7. Hold-up Time.....	7	23. Application Notes.....	19
8. DC-OK Relay Contact .....	7	23.1. Peak Current Capability .....	19
9. Efficiency and Power Losses.....	8	23.2. Back-feeding Loads .....	19
10. Lifetime Expectancy and MTBF.....	9	23.3. External Input Protection.....	20
11. Functional Diagram.....	9	23.4. Parallel Use to Increase Output Power....	20
12. Terminals and Wiring.....	10	23.5. Parallel Use for Redundancy .....	20
13. Front Side and User Elements.....	11	23.6. Series Operation .....	21
14. EMC.....	12	23.7. Inductive and Capacitive Loads.....	21
15. Environment.....	13	23.8. Charging of Batteries .....	21
16. Protection Features .....	14	23.9. Operation on Two Phases .....	22
17. Safety Features .....	14	23.10. Use in a Tightly Sealed Enclosure .....	22
18. Dielectric Strength .....	15		

The information presented in this document is believed to be accurate and reliable and may change without notice. No part of this document may be reproduced or utilized in any form without permission in writing from the publisher.

### TERMINOLOGY AND ABBREVIATIONS

<b>PE and  symbol</b>	PE is the abbreviation for <b>Protective Earth</b> and has the same meaning as the symbol  .
<b>Earth, Ground</b>	This document uses the term "earth" which is the same as the U.S. term "ground".
<b>T.b.d.</b>	To be defined, value or description will follow later.
<b>AC 230V</b>	A figure displayed with the AC or DC before the value represents a nominal voltage with standard tolerances included. E.g.: DC 12V describes a 12V battery disregarding whether it is full (13.7V) or flat (10V)
<b>230Vac</b>	A figure with the unit (Vac) at the end is a momentary figure without any additional tolerances included.
<b>50Hz vs. 60Hz</b>	As long as not otherwise stated, AC 100V and AC 230V parameters are valid at 50Hz mains frequency. AC 120V parameters are valid for 60Hz mains frequency.
<b>may</b>	A key word indicating flexibility of choice with no implied preference.
<b>shall</b>	A key word indicating a mandatory requirement.
<b>should</b>	A key word indicating flexibility of choice with a strongly preferred implementation.

### 1. INTENDED USE

This device is designed for installation in an enclosure and is intended for the general professional use such as in industrial control, office, communication, and instrumentation equipment.

Do not use this power supply in equipment, where malfunction may cause severe personal injury or threaten human life.

### 2. INSTALLATION REQUIREMENTS

This device may only be installed and put into operation by qualified personnel.

This device does not contain serviceable parts. The tripping of an internal fuse is caused by an internal defect.

If damage or malfunction should occur during installation or operation, immediately turn power off and send unit to the factory for inspection.

Mount the unit on a DIN-rail so that the input terminals are located on the bottom of the unit.

This device is designed for convection cooling and does not require an external fan. Do not obstruct airflow and do not cover ventilation grid (e.g. cable conduits) by more than 15%!

Keep the following installation clearances: 40mm on top, 20mm on the bottom, 5mm on the left and right sides are recommended when the device is loaded permanently with more than 50% of the rated power. Increase this clearance to 15mm in case the adjacent device is a heat source (e.g. another power supply).

A disconnecting means shall be provided for the output of the power supplies when used in applications according to CSA C22.2 No 107.1-01.

**⚠ WARNING** Risk of electrical shock, fire, personal injury or death.

- Do not use the power supply without proper grounding (Protective Earth). Use the terminal on the input block for earth connection and not one of the screws on the housing.
- Turn power off before working on the device. Protect against inadvertent re-powering.
- Make sure that the wiring is correct by following all local and national codes.
- Do not modify or repair the unit.
- Do not open the unit as high voltages are present inside.
- Use caution to prevent any foreign objects from entering the housing.
- Do not use in wet locations or in areas where moisture or condensation can be expected.
- Do not touch during power-on, and immediately after power-off. Hot surfaces may cause burns.

### 3. AC-INPUT

AC input	nom.	AC 100-120V / 200-240V	Auto-select, suitable for TN-, TT- and IT mains networks
AC input range	min.	90-132Vac / 180- 264Vac	continuous operation
	min.	264-300Vac	< 500ms
Allowed voltage L or N to earth	max.	300Vac	continuous, IEC 62103
Input frequency	nom.	50–60Hz	±6%
External input protection	See recommendations in chapter 23.3.		

		AC 100V	AC 120V	AC 230V	
Input current	typ.	2.0A	1.72A	1.05A	at 24V, 5A, see Fig. 3-3
Power factor <sup>*)</sup>	typ.	0.66	0.64	0.54	at 24V, 5A, see Fig. 3-4
Crest factor <sup>**)</sup>	typ.	2.7	2.8	3.4	at 24V, 5A
Turn-on voltage	typ.	78Vac	78Vac	157Vac	at 24V 0A, steady-state value, see Fig. 3-1
Shut-down voltage	typ.	68Vac	68Vac	68Vac	at 24V 5A, steady-state value, see Fig. 3-1
Start-up delay	typ.	400ms	400ms	100ms	see Fig. 3-2
Rise time	typ.	30ms	30ms	30ms	at 24V, 5A const. current load, 0mF load capacitance, see Fig. 3-2
	typ.	90ms	90ms	90ms	at 24V, 5A const. current load, 5mF load capacitance,, see Fig. 3-2
Turn-on overshoot	max.	200mV	200mV	200mV	see Fig. 3-2

\*) The power factor is the ratio of the true (or real) power to the apparent power in an AC circuit.

\*\*\*) The crest factor is the mathematical ratio of the peak value to RMS value of the input current waveform.

Fig. 3-1 Input voltage range, typ.

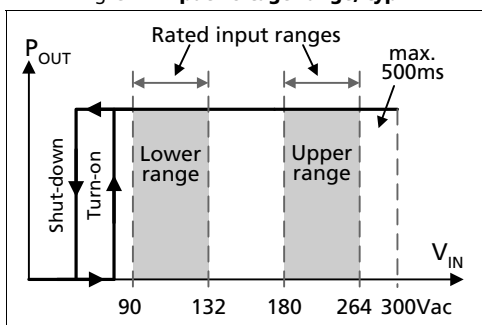

Fig. 3-3 Input current vs. output load at 24V

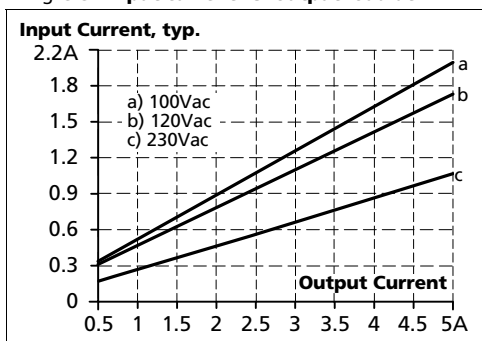

Fig. 3-2 Turn-on behavior, definitions

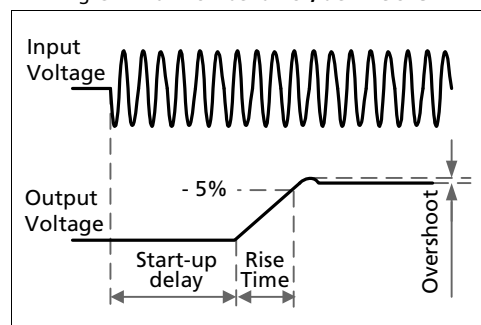
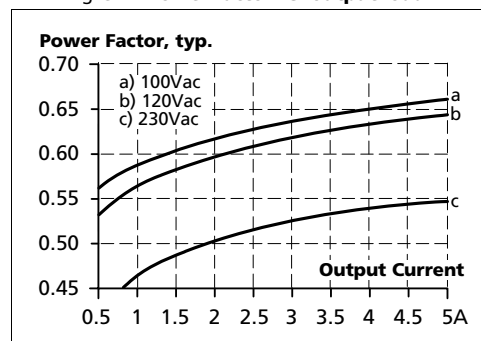

Fig. 3-4 Power factor vs. output load



### 4. DC-INPUT

Do not operate this power supply with DC-input voltage.

### 5. INPUT INRUSH CURRENT

A NTC inrush limiter limits the input inrush current after turn-on of the input voltage.

		AC 100V	AC 120V	AC 230V	
Inrush current <sup>*)</sup>	max.	23A <sub>peak</sub>	27A <sub>peak</sub>	40A <sub>peak</sub>	40°C ambient, cold start
	typ.	18A <sub>peak</sub>	22A <sub>peak</sub>	33A <sub>peak</sub>	40°C ambient, cold start
	typ.	13A <sub>peak</sub>	16A <sub>peak</sub>	30A <sub>peak</sub>	25°C ambient, cold start
Inrush energy <sup>*)</sup>	max.	0.4A <sup>2</sup> s	0.5A <sup>2</sup> s	1.5A <sup>2</sup> s	40°C ambient, cold start

<sup>\*)</sup> The charging current into EMI suppression capacitors is disregarded in the first microseconds after switch-on.

Fig. 5-1 Input inrush current, typical behavior  
230Vac input, 24V 5A output, 40°C ambient

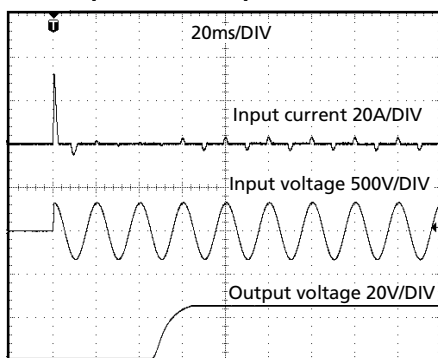
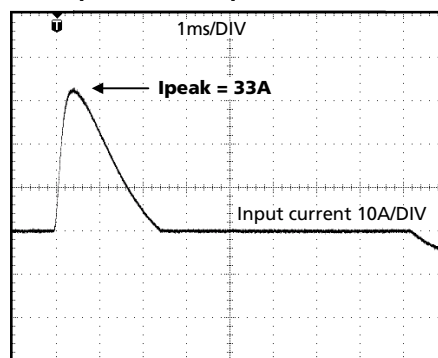

Fig. 5-2 Input inrush current, zoom into first peak  
230Vac input, 24V 5A output, 40°C ambient



### 6. OUTPUT

Output voltage	nom.	DC 24V	
Adjustment range	min.	24-28V	guaranteed
	max.	30V <sup>**)</sup>	at clockwise end position of potentiometer
Factory settings	typ.	24.1V	±0.2%, at full load, cold unit
Line regulation	max.	10mV	90-132 / 180-264Vac
Load regulation	max.	150mV	static value, 0A → 5A → 0A
Ripple and noise voltage	max.	100mVpp	20Hz to 20MHz, 50Ohm
Output current	for AC 110-120 / 220-240V mains voltages (includes AC 208V mains):		
	nom.	5A	at 24V, below +55°C ambient temperature
	nom.	4.3A	at 28V, below +55°C ambient temperature
	nom.	3.1A	at 24V, at +70°C ambient temperature
	nom.	2.7A	at 28V, at +70°C ambient temperature
	Derate linearly between +55°C and +70°C		
	for AC 100 / 200V mains voltages:		
	nom.	5A	at 24V, below +50°C ambient temperature
nom.	4.3A	at 28V, below +50°C ambient temperature	
nom.	2.5A	at 24V, at +70°C ambient temperature	
nom.	2.1A	at 28V, at +70°C ambient temperature	
Derate linearly between +50°C and +70°C			
Overload behaviour	continuous current	output voltage > 10Vdc, see Fig. 6-1	
	Intermittent	output voltage < 10Vdc, see Fig. 6-1	
Short-circuit current	typ.	3.5A <sup>*)</sup>	average (R.M.S.) current, load impedance 50mOhm
Output capacitance	typ.	2 050µF	included inside the power supply

\*) Discharge current of output capacitors is not included.

\*\*\*) This is the maximum output voltage which can occur at the clockwise end position of the potentiometer due to tolerances. It is not guaranteed value which can be achieved. The typical value is about 28.5V.

Fig. 6-1 Output voltage vs. output current, RMS current, typ.

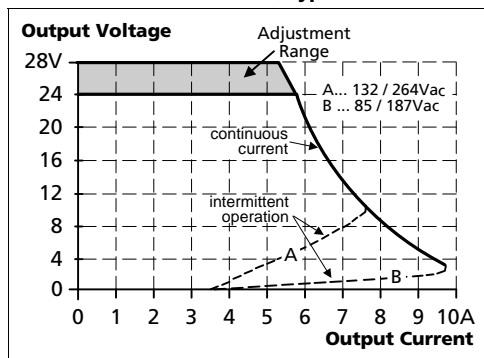
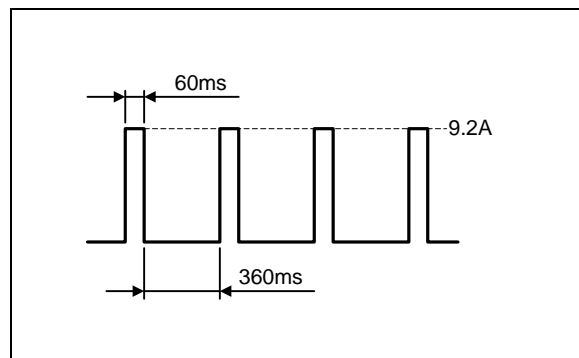

Fig. 6-2 Intermittent operation at shorted output, typ.



### 7. HOLD-UP TIME

		AC 100V	AC 120V	AC 230V	
Hold-up Time	typ.	64ms	108ms	105ms	at 24V, 2.5A, see Fig. 7-1
	min.	54ms	91ms	88ms	at 24V, 2.5A, see Fig. 7-1
	typ.	26ms	51ms	50ms	at 24V, 5A, see Fig. 7-1
	min.	22ms	43ms	42ms	at 24V, 5A, see Fig. 7-1

Fig. 7-1 Hold-up time vs. input voltage

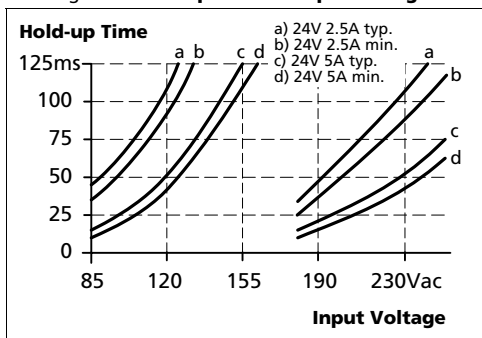
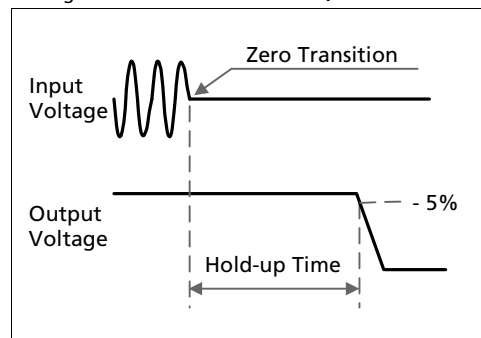

Fig. 7-2 Shut-down behavior, definitions



### 8. DC-OK RELAY CONTACT

This feature monitors the output voltage, which is produced by the power supply itself. It is independent of a back-fed voltage from a unit connected in parallel to the power supply output (e.g. redundant application).

Contact closes	As soon as the output voltage reaches 21.4V.		
Contact opens	As soon as the output voltage dips below 21.4V.		
Contact ratings	max.	60Vdc 0.3A, 30Vdc 1A, 30Vac 0.5A	resistive load
	min.	1mA at 5Vdc	minimum required load
Isolation voltage	See dielectric strength table in section 18.		

Fig. 8-1 DC-ok relay contact behavior

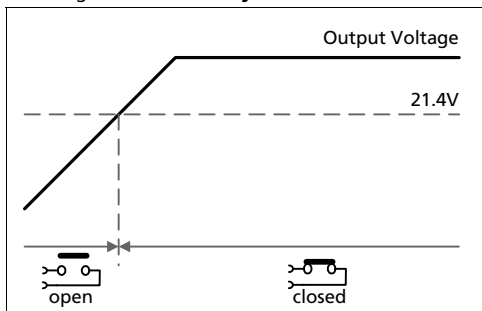

### 9. EFFICIENCY AND POWER LOSSES

		AC 100V	AC 120V	AC 230V	
Efficiency	typ.	90.7%	91.2%	92.3%	at 24V, 5A
Average efficiency*)	typ.	89.2%	89.4%	90.6%	25% at 1.25A, 25% at 2.5A, 25% at 3.75A, 25% at 5A
Power losses	typ.	1.4W	1.5W	0.7W	at 24V, 0A
	typ.	7.0W	7.4W	6.0W	at 24V, 2.5A
	typ.	12.3W	11.6W	10.0W	at 24V, 5A

\*) The average efficiency is an assumption for a typical application where the power supply is loaded with 25% of the nominal load for 25% of the time, 50% of the nominal load for another 25% of the time, 75% of the nominal load for another 25% of the time and with 100% of the nominal load for the rest of the time.

Fig. 9-1 Efficiency vs. output current at 24V, typ.

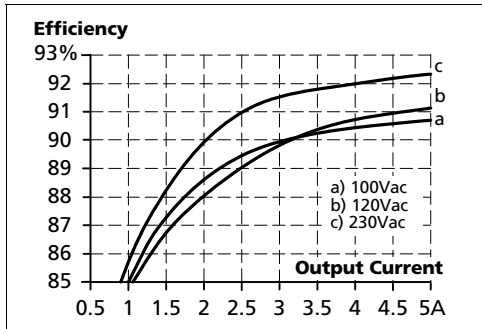

Fig. 9-2 Losses vs. output current at 24V, typ.

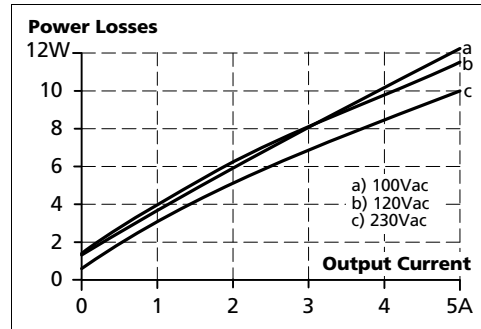

Fig. 9-3 Efficiency vs. input voltage at 24V, 5A, typ.

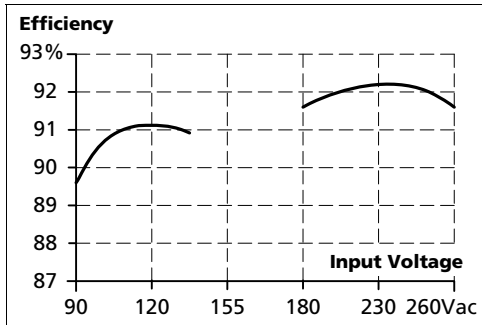
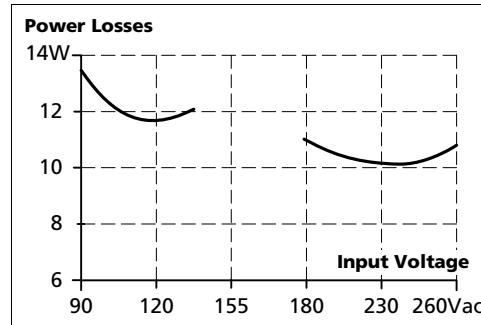

Fig. 9-4 Losses vs. input voltage at 24V, 5A, typ.





### 10. LIFETIME EXPECTANCY AND MTBF

	AC 100V	AC 120V	AC 230V	
Lifetime expectancy <sup>*)</sup>	181 000h <sup>*)</sup>	194 000h <sup>*)</sup>	219 000h <sup>*)</sup>	at 24V, 2.5A and 40°C
	511 000h <sup>*)</sup>	548 000h <sup>*)</sup>	621 000h <sup>*)</sup>	at 24V, 2.5A and 25°C
	66 000h	68 000h	83 000h	at 24V, 5A and 40°C
	188 000h <sup>*)</sup>	193 000h <sup>*)</sup>	234 000h <sup>*)</sup>	at 24V, 5A and 25°C
MTBF <sup>**) SN 29500, IEC 61709</sup>	1 065 000h	1 147 000h	1 379 000h	at 24V, 5A and 40°C
	2 038 000h	2 166 000h	2 519 000h	at 24V, 5A and 25°C
MTBF <sup>**) MIL HDBK 217F</sup>	681 000h	651 000h	645 000h	at 24V, 5A and 40°C; Ground Benign GB40
	872 000h	842 000h	839 000h	at 24V, 5A and 25°C; Ground Benign GB25
	165 000h	164 000h	168 000h	at 24V, 5A and 40°C; Ground Fixed GF40
	206 000h	205 000h	211 000h	at 24V, 5A and 25°C; Ground Fixed GF25

- \*) The **Lifetime expectancy** shown in the table indicates the minimum operating hours (service life) and is determined by the lifetime expectancy of the built-in electrolytic capacitors. Lifetime expectancy is specified in operational hours and is calculated according to the capacitor's manufacturer specification. The manufacturer of the electrolytic capacitors only guarantees a maximum life of up to 15 years (131 400h). Any number exceeding this value is a calculated theoretical lifetime which can be used to compare devices.
- \*\*) **MTBF** stands for **Mean Time Between Failure**, which is calculated according to statistical device failures, and indicates reliability of a device. It is the statistical representation of the likelihood of a unit to fail and does not necessarily represent the life of a product. The MTBF figure is a statistical representation of the likelihood of a device to fail. A MTBF figure of e.g. 1 000 000h means that statistically one unit will fail every 100 000 units are installed in the field. However, it can not be determined if the failed unit has been running for 50 000h or only for 100h.

### 11. FUNCTIONAL DIAGRAM

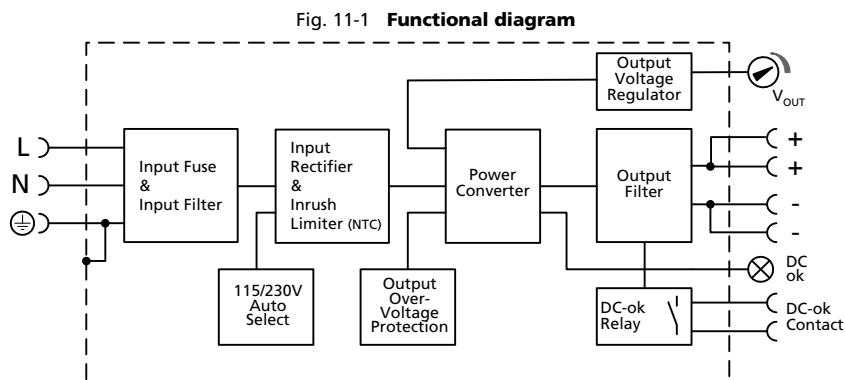

## 12. TERMINALS AND WIRING

The terminals are IP20 finger safe constructed and suitable for field- and factory wiring.

	<b>Input and output</b>	<b>DC-OK-Signal</b>
<b>Type</b>	screw terminals	push-in terminals
Solid wire	max. 6mm <sup>2</sup>	max. 1.5mm <sup>2</sup>
Stranded wire	max. 4mm <sup>2</sup>	max. 1.5mm <sup>2</sup>
American Wire Gauge	AWG20-10	AWG28-16
Max. wire diameter	2.8mm (including ferrules)	1.6mm (including ferrules)
Wire stripping length	7mm / 0.28inch	7mm / 0.28inch
Screwdriver	3.5mm slotted or cross-head No 2	not required
Recommended tightening torque	1Nm, 9lb.in	not applicable

### Instructions:

- a) Use appropriate copper cables that are designed for minimum operating temperatures of:
  - 75°C for ambient up to 55°C minimum and
  - 90°C for ambient up to 70°C minimum.
- b) Follow national installation codes and installation regulations!
- c) Ensure that all strands of a stranded wire enter the terminal connection!
- d) Do not use the unit without PE connection.
- e) Unused terminal compartments should be securely tightened.
- f) Ferrules are allowed.

### 13. FRONT SIDE AND USER ELEMENTS

Fig. 13-1 Front side

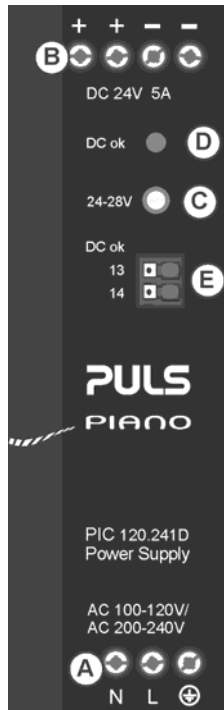

**A Input Terminals** (screw terminals)

**N, L** Line input

$\oplus$  PE (Protective Earth) input

**B Output Terminals** (screw terminals, two pins per pole)

**+** Positive output

**-** Negative (return) output

**C Output voltage potentiometer**

Guaranteed adjustment range: 24-28V

Factory set: 24.1V

**D DC-OK LED** (green)

On, when the output voltage is >18V

**E DC-OK Relay Contact** (push-in terminals)

Description see chapter 8.

### 14. EMC

The power supply is suitable for applications in industrial environment as well as in residential, commercial and light industry environment. A detailed EMC report is available on request.

<b>EMC Immunity</b>		According generic standards: EN 61000-6-1 and EN 61000-6-2		
Electrostatic discharge	EN 61000-4-2	contact discharge air discharge	8kV 8kV	Criterion A Criterion A
Electromagnetic RF field	EN 61000-4-3	80MHz-2.7GHz	20V/m	Criterion A
Fast transients (Burst)	EN 61000-4-4	input lines	4kV	Criterion A
		output lines	2kV	Criterion A
		DC-OK signal (coupling clamp)	2kV	Criterion A
Surge voltage on input	EN 61000-4-5	L → N	2kV	Criterion A
		L → PE, N → PE	4kV	Criterion A
Surge voltage on output	EN 61000-4-5	+ → -	500V	Criterion A
		+ / - → PE	1kV	Criterion A
Surge voltage on DC-OK	EN 61000-4-5	DC-OK signal → PE	1kV	Criterion A
Conducted disturbance	EN 61000-4-6	0.15-80MHz	20V	Criterion A
Mains voltage dips	EN 61000-4-11	0% of 100Vac	0Vac, 20ms	Criterion A
		40% of 100Vac	40Vac, 200ms	Criterion C
		70% of 100Vac	70Vac, 500ms	Criterion A *)
		0% of 200Vac	0Vac, 20ms	Criterion A
		40% of 200Vac	80Vac, 200ms	Criterion C
		70% of 200Vac	140Vac, 500ms	Criterion A
Voltage interruptions	EN 61000-4-11	0% of 220Vac (=0V)	5000ms	Criterion C
Voltage sags	SEMI F47 0706	dips on the input voltage according to SEMI F47 standard		
		80% of 208Vac (166Vac)	1000ms	Criterion A
		70% of 208Vac (146Vac)	500ms	Criterion A
		50% of 208Vac (104Vac)	200ms	Criterion C
		80% of 120Vac (96Vac)	1000ms	Criterion A
		70% of 120Vac (84Vac)	500ms	Criterion A
50% of 120Vac (60Vac)	200ms	Criterion C		
Powerful transients	VDE 0160	over entire load range	750V, 1.3ms	Criterion A

**Criteria:**

**A:** Power supply shows normal operation behavior within the defined limits.

**C:** Temporary loss of function is possible. Power supply may shut-down and restarts by itself. No damage or hazards for the power supply will occur.

\*) below 4.5A, Criterion C for currents > 5A

<b>EMC Emission</b>		According generic standards: EN 61000-6-3, EN 61000-6-4	
Conducted emission input lines	EN 55011, EN 55022, FCC Part 15, CISPR 11, CISPR 22	Class B	
Conducted emission output lines**)	IEC/CISPR 16-1-2, IEC/CISPR 16-2-1	limits for DC power port according EN 61000-6-3 not fulfilled	
Radiated emission	EN 55011, EN 55022	Class B	
Harmonic input current	EN 61000-3-2	fulfilled for class A equipment	
Voltage fluctuations, flicker	EN 61000-3-3	fulfilled*)	

This device complies with FCC Part 15 rules.

Operation is subjected to following two conditions: (1) this device may not cause harmful interference, and (2) this device must accept any interference received, including interference that may cause undesired operation.

\*) tested with constant current loads, non pulsing

\*\*\*) for information only, not mandatory for EN 61000-6-3

Switching frequency

Main converter 40kHz to 120kHz for load current range between 1A - 5A

## 15. ENVIRONMENT

Operational temperature <sup>*)</sup>	-10°C to +70°C (14°F to 158°F)	reduce output power according Fig. 15-1
Storage temperature	-40°C to +85°C (-40°F to 185°F)	for storage and transportation
Output de-rating	3W/°C (55°C to 70°C; 131°F to 158°F) 3W/°C (50°C to 70°C; 122°F to 158°F)	for AC 110-120 / 220-240V mains systems <sup>****)</sup> for AC 100 / 200V mains systems <sup>****)</sup>
Humidity <sup>**)</sup>	5 to 95% r.h.	IEC 60068-2-30
Vibration sinusoidal	2-17.8Hz: ±1.6mm; 17.8-500Hz: 2g <sup>***)</sup> 2 hours / axis <sup>***)</sup>	IEC 60068-2-6
Shock	30g 6ms, 20g 11ms <sup>***)</sup> 3 bumps / direction, 18 bumps in total	IEC 60068-2-27
Altitude	0 to 2000m (0 to 6 560ft) 2000 to 6000m (6 560 to 20 000ft)	without any restrictions reduce output power or ambient temperature, see Fig. 15-2 IEC 62103, EN 50178, overvoltage category II
Altitude de-rating	7.5W/1000m or 5°C/1000m	> 2000m (6500ft), see Fig. 15-2
Over-voltage category	III II	IEC 62103, EN 50178, altitudes up to 2000m altitudes from 2000m to 6000m
Degree of pollution	2	IEC 62103, EN 50178, not conductive
LABS compatibility	The unit does not release any silicone or other LABS-critical substances and is suitable for use in paint shops.	

\*) Operational temperature is the same as the ambient or surrounding temperature and is defined as the air temperature 2cm below the unit.

\*\*\*) Do not energize while condensation is present

\*\*\*\*) Tested on a DIN-Rail with a thickness of 1.3mm.

\*\*\*\*\*) For AC 208V mains use AC 200-220V values.

Fig. 15-1 Output current vs. ambient temp.

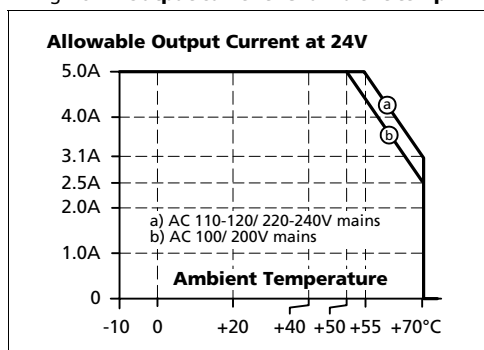
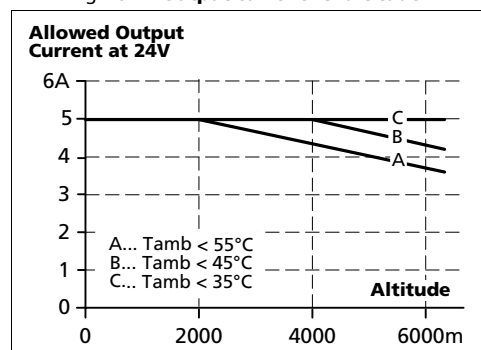

Fig. 15-2 Output current vs. altitude



### 16. PROTECTION FEATURES

Output protection	Electronically protected against overload, no-load and short-circuits <sup>*)</sup>	
Output over-voltage protection	typ. 31Vdc max. 34Vdc	In case of an internal power supply defect, a redundant circuit limits the maximum output voltage. In such a case, the output shuts down and stays down until the input voltage is turned off and on again for at least one minute or until the green LED went off.
Degree of protection	IP 20	EN/IEC 60529 Caution: For use in a controlled environment according to CSA 22.2 No 107.1-01.
Over-temperature protection	no	
Input transient protection	MOV (Metal Oxide Varistor)	
Internal input fuse	included	not user replaceable

\*) In case of a protection event or in a low-load condition, audible noise may occur.

### 17. SAFETY FEATURES

Input / output separation	SELV PELV double or reinforced insulation	IEC/EN 60950-1 IEC/EN 60204-1, EN 50178, IEC 62103, IEC 60364-4-41
Class of protection	I	PE (Protective Earth) connection required
Isolation resistance	> 100MΩ	input to output, 500Vdc
Touch current (leakage current)	typ. 0.21mA / 0.46mA typ. 0.30mA / 0.65mA typ. 0.33mA / 0.72mA < 0.27mA / 0.56mA < 0.38mA / 0.78mA < 0.43mA / 0.90mA	100Vac, 50Hz, TN-,TT-mains / IT-mains 120Vac, 60Hz, TN-,TT-mains / IT-mains 230Vac, 50Hz, TN-,TT-mains / IT-mains 110Vac, 50Hz, TN-,TT-mains / IT-mains 132Vac, 60Hz, TN-,TT-mains / IT-mains 264Vac, 50Hz, TN-,TT-mains / IT-mains

### 18. DIELECTRIC STRENGTH

The output voltage is floating and has no ohmic connection to the ground. Type and factory tests are conducted by the manufacturer. Field tests may be conducted in the field using the appropriate test equipment, which applies the voltage with a slow ramp (2s up and 2s down). Connect all input-terminals together as well as all output poles before conducting the test. When testing, set the cut-off current settings to the value in the table below.

Fig. 18-1 Dielectric strength

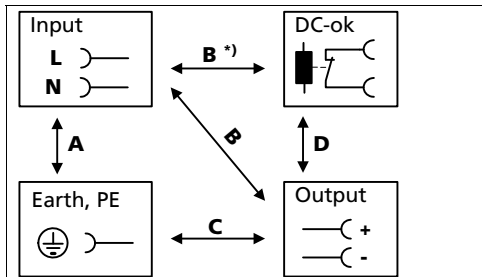





B\*) When testing input to DC-OK ensure that the max. voltage between DC-OK and the output is not exceeded (column D). We recommend connecting DC-OK pins and the output pins together when performing the test.



		A	B	C	D
Type test	60s	2500Vac	3000Vac	1000Vac	500Vac
Factory test	5s	2500Vac	2500Vac	500Vac	500Vac
Field test	5s	2000Vac	2000Vac	500Vac	500Vac
Cut-off current setting		> 10mA	> 10mA	> 15mA	> 1mA

To fulfil the PELV requirements according to EN60204-1 § 6.4.1, we recommend that either the + pole, the - pole or any other part of the output circuit shall be connected to the protective earth system. This helps to avoid situations in which a load starts unexpectedly or can not be switched off when unnoticed earth faults occur.

### 19. APPROVALS

EC Declaration of Conformity		The CE mark indicates conformance with the - EMC directive 2004/108/EC and the - Low-voltage directive (LVD) 2006/95/EC
IEC 60950-1 2 <sup>nd</sup> Edition, planned		CB Scheme, Information Technology Equipment
UL 60950-1 2 <sup>nd</sup> Edition, planned		Recognized for use as Information Technology Equipment, Level 5; U.S.A. (UL 60950-1) and Canada (C22.2 No. 60950-1); E-File: E137006 Applicable for altitudes up to 2000m.
UL 508, planned		Listed for use as Industrial Control Equipment; U.S.A. (UL 508) and Canada (C22.2 No. 107-1-01); E-File: E198865
EAC TR Registration		Registration for the Eurasian Customs Union market (Russia, Kazakhstan, Belarus)

### 20. ROHS, REACH AND OTHER FULFILLED STANDARDS

RoHS Directive		Directive 2011/65/EU of the European Parliament and the Council of June 8 <sup>th</sup> , 2011 on the restriction of the use of certain hazardous substances in electrical and electronic equipment.
REACH Directive		Directive 1907/2006/EU of the European Parliament and the Council of June 1 <sup>st</sup> , 2007 regarding the Registration, Evaluation, Authorisation and Restriction of Chemicals (REACH)



### 21. PHYSICAL DIMENSIONS AND WEIGHT

Width	39mm 1.54"
Height	124mm 4.88"
Depth	124mm 4.88" The DIN-rail height must be added to the unit depth to calculate the total required installation depth.
Weight	370g / 0.81lb
DIN-Rail	Use 35mm DIN-rails according to EN 60715 or EN 50022 with a height of 7.5 or 15mm.
Plastic Material of Housing	Flame retardant Polycarbonate (PC) - UL94-V0 Vicat softening temperature specified with 149°C according to ASTM D1525
Installation Clearances	See chapter 2

Fig. 21-1 Front view

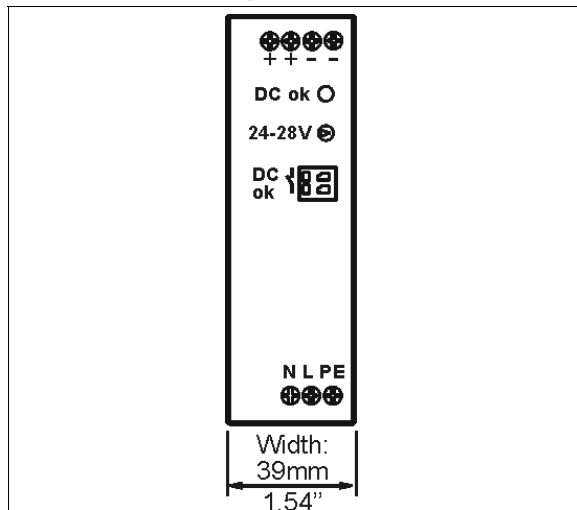
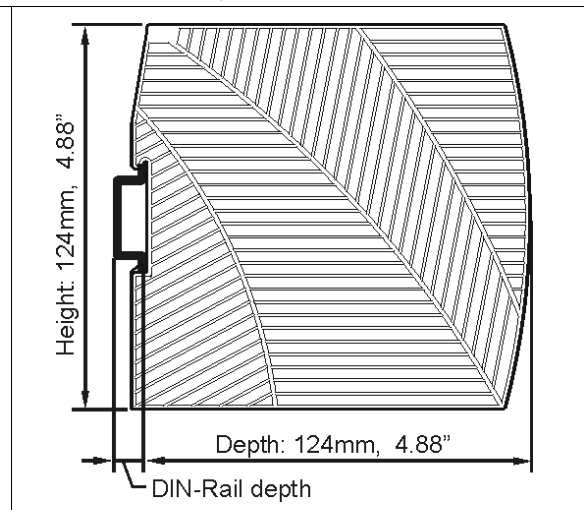

Fig. 21-2 Side view



## 22. ACCESSORY

### 22.1. UF20.241 BUFFER MODULE

This buffer unit is a supplementary device for DC 24V power supplies. It delivers power to bridge typical mains failures or extends the hold-up time after turn-off of the AC power. In times when the power supply provides sufficient voltages, the buffer module stores energy in integrated electrolytic capacitors. In case of mains voltage fault, this energy is released again in a regulated process. One buffer module can deliver 20A which can also be used to support peak current demands.



The buffer unit does not require any control wiring. It can be added in parallel to the load circuit at any given point. Buffer units can be added in parallel to increase the output ampacity or the hold-up time.

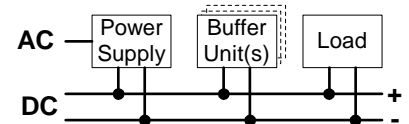

### 22.2. YR2.DIODE REDUNDANCY MODULE

The YR2.DIODE is a dual redundancy module, which has two diodes with a common cathode included. It can be used for various purposes. The most popular application is to configure highly reliable and true redundant power supply systems. Another interesting application is the separation of sensitive loads from non-sensitive loads. This avoids the distortion of the power quality for the sensitive loads which can cause controller failures.



See chapter 23.5 for instructions how to build a redundant system.

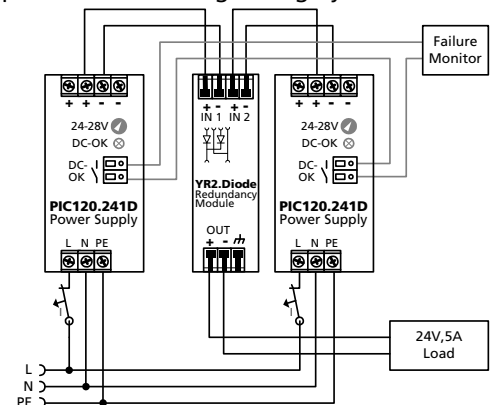

### 23. APPLICATION NOTES

#### 23.1. PEAK CURRENT CAPABILITY

The unit can deliver peak currents (up to several milliseconds) which are higher than the specified short term currents. This helps to start current demanding loads. Solenoids, contactors and pneumatic modules often have a steady state coil and a pick-up coil. The inrush current demand of the pick-up coil is several times higher than the steady-state current and usually exceeds the nominal output current. The same situation applies when starting a capacitive load. The peak current capability also ensures the safe operation of subsequent circuit breakers of load circuits. The load branches are often individually protected with circuit breakers or fuses. In case of a short or an overload in one branch circuit, the fuse or circuit breaker need a certain amount of over-current to open in a timely manner. This avoids voltage loss in adjacent circuits.

The extra current (peak current) is supplied by the power converter and the built-in large sized output capacitors of the power supply. The capacitors get discharged during such an event, which causes a voltage dip on the output. The following two examples show typical voltage dips:

Fig. 23-1 **Peak load with 2x the nominal current for 50ms, typ.**

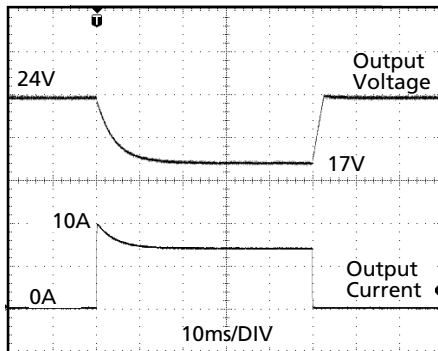

10A Peak load (resistive) for 50ms  
Output voltage dips from 24V to 17V.

Fig. 23-2 **Peak load with 5x the nominal current for 5ms, typ.**

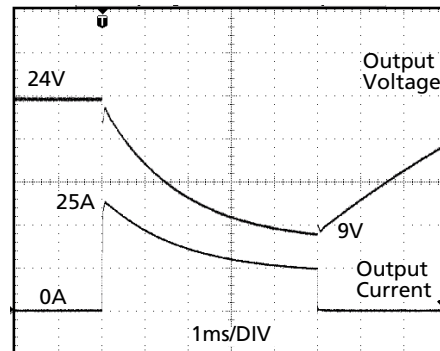

25A Peak load (resistive) for 5ms  
Output voltage dips from 24V to 9V.

Peak current voltage dips	typ.	from 24V to 17V	at 10A for 50ms, resistive load
	typ.	from 24V to 13V	at 25A for 2ms, resistive load
	typ.	from 24V to 9V	at 25A for 5ms, resistive load

#### 23.2. BACK-FEEDING LOADS

Loads such as decelerating motors and inductors can feed voltage back to the power supply. This feature is also called return voltage immunity or resistance against Back- E.M.F. (Electro Magnetic Force).

This power supply is resistant and does not show malfunctioning when a load feeds back voltage to the power supply. It does not matter whether the power supply is on or off.

The maximum allowed feed-back-voltage is 35Vdc. The absorbing energy can be calculated according to the built-in large sized output capacitor which is specified in chapter 6.

### 23.3. EXTERNAL INPUT PROTECTION

The unit is tested and approved for branch circuits up to 30A (UL) and 32A (IEC). An external protection is only required if the supplying branch has an ampacity greater than this. Check also local codes and local requirements. In some countries local regulations might apply.

If an external fuse is necessary or utilized, minimum requirements need to be considered to avoid nuisance tripping of the circuit breaker. A minimum value of 10A B- or 6A C-Characteristic breaker should be used.

### 23.4. PARALLEL USE TO INCREASE OUTPUT POWER

Do not use the power supply in parallel to increase the output power.

### 23.5. PARALLEL USE FOR REDUNDANCY

Power supplies can be paralleled for redundancy to gain higher system availability. Redundant systems require a certain amount of extra power to support the load in case one power supply unit fails. The simplest way is to put two power supplies in parallel. This is called a 1+1 redundancy. In case one power supply unit fails, the other one is automatically able to support the load current without any interruption.

**Please note:** This simple way to build a redundant system does not cover failures such as an internal short circuit in the secondary side of the power supply. In such a case, the defect unit becomes a load for the other power supplies and the output voltage can not be maintained any more. This can only be avoided by utilizing decoupling diodes which are included in the redundancy module YR2.DIODE.

Recommendations for building redundant power systems:

- Use the DC-OK signal contact to monitor the individual power supply units.
- Use separate input fuses for each power supply.
- Use separate mains systems for each power supply whenever it is possible.
- It is desirable to set the output voltages of all units to the same value ( $\pm 100\text{mV}$ ) or leave it at the factory setting.

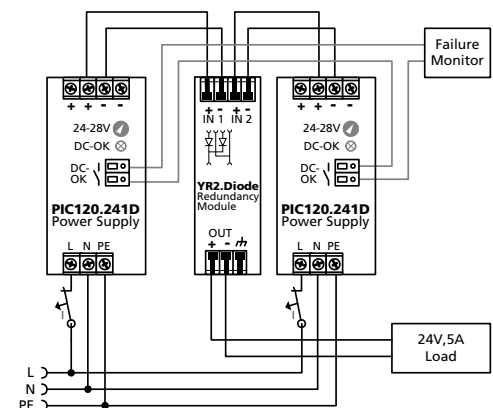

### 23.6. SERIES OPERATION

Power supplies of the same type can be connected in series for higher output voltages. It is possible to connect as many units in series as needed, providing the sum of the output voltage does not exceed 150Vdc. Voltages with a potential above 60Vdc are not SELV any more and can be dangerous. Such voltages must be installed with a protection against touching.

Earthing of the output is required when the sum of the output voltage is above 60Vdc.

Avoid return voltage (e.g. from a decelerating motor or battery) which is applied to the output terminals.

Keep an installation clearance of 15mm (left / right) between two power supplies and avoid installing the power supplies on top of each other.

Pay attention that leakage current, EMI, inrush current, harmonics will increase when using multiple power supplies.

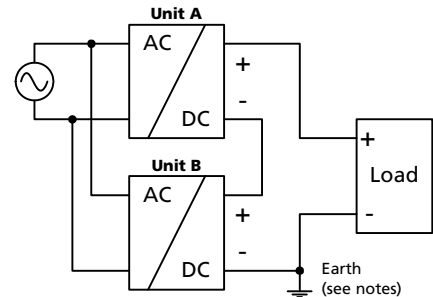

### 23.7. INDUCTIVE AND CAPACITIVE LOADS

No limitations for inductive loads

No limitations for capacitive loads in combination with an additional resistive type of load.

Limitations apply for capacitive loads in combination with constant current type of loads:

- max. 20mF with an additional 2.5A constant current load and
- max. 10mF with an additional 5A constant current load.

### 23.8. CHARGING OF BATTERIES

Do not use the power supply to charge batteries.

### 23.9. OPERATION ON TWO PHASES

The power supply can also be used on two-phases of a three-phase-system. Such a phase-to-phase connection is allowed as long as the supplying voltage is below  $240V^{+10\%}$ .

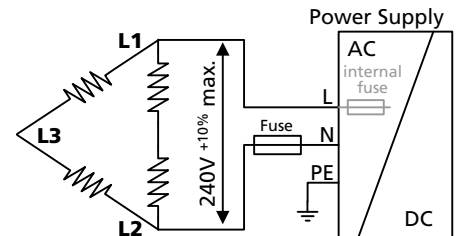

### 23.10. USE IN A TIGHTLY SEALED ENCLOSURE

When the power supply is installed in a tightly sealed enclosure, the temperature inside the enclosure will be higher than outside. In such situations, the inside temperature defines the ambient temperature for the power supply.

The following measurement results can be used as a reference to estimate the temperature rise inside the enclosure.

The power supply is placed in the middle of the box; no other heat producing items are inside the box.

Enclosure: Rittal Type IP66 Box PK 9516 100, plastic, 110x180x165mm  
 Input: 230Vac

#### Case A:

Load: 24V, 5A; load is placed outside the box  
 Temperature inside the box: 41.5°C (in the middle of the right side of the power supply with a distance of 1cm)  
 Temperature outside the box: 24.4°C  
 Temperature rise: 17.1K

#### Case B:

Load: 24V, 4A; (=80%) load is placed outside the box  
 Temperature inside the box: 38.9°C (in the middle of the right side of the power supply with a distance of 1cm)  
 Temperature outside the box: 24.2°C  
 Temperature rise: 14.5K