



Twist-Strip™

DMCT DANIELS
MANUFACTURING
CORPORATION®

IMPORTANT



Important Note from Manufacturer: Prior to the use of this tool, the operator should take a sample of the wire they will be using and test the viability of the strip. Adjustments may be needed for desired outcome that vary from the factory recommendation.



Important Note from Manufacturer: Different suppliers and/or production runs of cable can vary in key strip dimensions and properties. Inspect frequently and readjust blade depth if necessary.



Important Note from Manufacturer: Care should be taken when handling insulation or shielding as nicked, frayed, or broken strands can cause injury.

We are committed to Daniels Manufacturing Corporation (DMC) remaining the major supplier of high reliability tools and maintenance kits for electronic wiring systems to the global aerospace, military, transportation, electrical, and electronic industries through our continuous improvement of all our business practices and processes while, at the same time, maintaining the economic viability of our business.

- *George Daniels, President*



To meet this commitment, Daniels Manufacturing Corporation maintains an ISO9001/AS9100 Registered Quality Management System.

WWW.DMCTOOLS.COM

Phone: (407) 855-6161

Fax: (407) 855-6884

1.0 Introduction 1

1.1 Overview of Existing Practices 1

1.2 Product Overview 2

1.3 Cable Variances 2

2.0 Tool Features..... 3

2.1 TS8000 Key Features 3

2.2 Interchangeable Dies 3

3.0 Die and Die Container Information 4

3.1 Definitions 4

3.2 Die Set Identification 4

3.3 Die Set Part Numbering System 5

3.4 Die Set Selection Notes..... 6

3.5 Cable Diameter Gauge Card 6

4.0 Tool Anatomy 8

5.0 TS8000 Operation Overview9

5.1 Opening and Closing 9

5.2 Installing Dies..... 10

5.3 Release Arms to Operate Tool..... 11

5.4 Setting Cable Strip Length 12

5.5 Inserting Cable..... 13

5.6 Stripping the Cable..... 14

5.7 Crack and Peel the Jacket 15

5.8 Damage or Improper Strip..... 16

6.0 Depth Control Knobs..... 17

6.1 Adjusting Blade Depth..... 18

7.0 TS8000 Testing Procedures 19

7.1 TS8000 Strip Test Procedures..... 18

7.2 Accuracy of Strip Test 18

8.0 Quality Check When Inserting Dies 18

9.0 TS8000 Specifications 19

9.1 Tool Specifications..... 20

9.2 Cable Specifications 20

9.3 Other Cable Specifications..... 20

10.0 NEMA WC 27500 Shielded and Unshielded Cable Part Numbering System..... 21

11.0 Jacket Material 22

12.0 Troubleshooting 23

12.1 Tool Arms Will Not Open 23

12.2 Arms Will Not Stay Closed With Die Set Installed 23

12.3 Arms Will Not Stay Closed with a Die Set NOT Installed 23

12.4 One Side of the Die Set is Cutting too Deeply/Shallow..... 23

13.0 Maintenance, Precautions, Service & Repair..... 23

14.0 Contact Info for DMC Recalibration and Repair 24

15.0 Custom Dies..... 24

16.0 Warranty Statement..... 24

Patent, Trademark, and Copyright Information

The configuration and general design of the TS8000 Twist-Strip™ tool and related dies follows the content of US Patent #7,243,429.

Twist-Strip™, DMC, and Daniels Manufacturing Corp. are registered Trademarks and Logos of the Daniels Manufacturing Corporation, Orlando, Florida (USA).

This manual and other publications relating to Twist-Strip™ Tooling are copyrighted by Daniels Manufacturing Corp., and shall not be used or duplicated without express written permission of DMC.

1.0 INTRODUCTION:

It is common for high-speed data cable to utilize one or more shielded twisted conductors. This type of cable is common in all digital electronic networks, and it requires new tooling disciplines.

The TS8000 Twist-Strip™ tool is a cable jacket stripper designed to slit the jacket on multi-conductor shielded twisted cable. Safe, accurate and repeatable, the Twist-Strip™ makes quick work of avionics harnesses and many other cable types, cutting preparation time by up to 3 - 5+ times. The challenge in designing a wire prep system of this type is the non-circular configuration of the cable, and the many types, variations, and stripping nuances of shielded, twisted, multi-wire cable. DMC's intention of the Twist-Strip™ product line is to give the user a system with the maximum capabilities, while keeping the system portable, self-contained, affordable, and ergonomic. The precise blade adjustment, zero friction roller bearing design, articulating/locking arms, and changeable dies make the Twist-Strip™ very user-friendly and efficient when performing the difficult task of cable preparation.

1.1 Overview of Existing Practices:

Removing the jacket from multi-conductor cable is often done by hand with a razor blade. This is a dangerous and difficult way to remove the jacket from any type of electrical cable. A razor blade offers no method of controlling the depth of cut. This will result in a poor quality strip, damage to the shielding, and the probability of injury to the operator.

Tools which score a ring around the outer jacket, but don't slit the jacket horizontally leave the operator with the task of removing a long jacket segment by force. This causes operator fatigue, and the friction caused by pulling wire slugs across the cable can open large windows in the braided shielding, therefore making the shielding less effective.

A few benchtop strippers are available for oval cable, but none are portable, and all are expensive. One very popular benchtop stripper for oval wire weighs 24 pounds, and still requires the operator to pull the insulation slug off the cable.

Laser stripping is another precise method for wire stripping, however it is expensive and has multiple hazards. Laser stripping emits toxic fumes when burning the outer jacket and can be a potential exposure to radiation. The laser stripping process requires a tight braid layer to stop the laser energy. It can penetrate below openings in the woven wire braid and burn holes in the insulation of the inner conductors. When this occurs, solder can reach the inner conductors and cause electrical shorting to ground.

1.2 Product Overview:

The patented TS8000 Twist-Strip™ tool utilizes custom-made die sets and precise adjustable cutting blades. The adjustable blades allow the tool to compensate for minor thickness variances in the cable jacket and lay length with significantly less downtime. An engineered cabletrack in the dies is contoured to match the outer jacket profile of the cable being stripped. This feature provides controlled rotation of the dies to guide the cutting blades in a precise track along the length of the cable. The Twist-Strip™ is the best way to remove the outer jacket from twisted, shielded multi-conductor cable. The TS8000 eliminates the need for imprecise and dangerous razor blades. The TS8000 die sets can accommodate an outer diameter range of cables from .071" to .180".

1.3 Cable Variances

Multi conductor shielded twisted cables can have variations despite being supplied by the same manufacturer; with the same lot code, date code, and/or part number. Varying jacket thickness and cable diameter are two examples of common differences that may be seen in different lots of the same cable.

Since the cable standards are based on the performance of the cable rather than dimensional conformance, it has been our observation that outside dimensions have varied by as much as .030", twist pitch (lay) can vary by as much as 40%, and jacket thickness has been observed to vary by as much as .007". The variations are often increased when the cables are produced in different lots, or by different manufacturers, and supplied under the same part numbers. By selecting a matched die set, and by adjusting the blade cutting depths the TS8000 can accommodate a wide range of configurations and variations in high-speed data cables. Tape wrapped jacketing (rather than smooth extruded insulation) frequently exhibits greater difficulties when removing the outer jacket. This is due to the inconsistent jacket thickness between the overlapping tape joints, but the adjustable depth feature of the TS8000 Twist-Strip™ tool can still be effective on tape wrapped cable constructions. DMC recommends adjusting the blade to a shallower depth in order to decrease damage to the shielding.

Important Note: *Prior to use of this tool in production the end user will have to test this depth and ensure the viability of the strip. Adjustments may be needed for desired outcomes that vary from the factory recommendation.*

2.0 TOOL FEATURES:

2.1 TS8000 Key Features

Key Features incorporated into the design/configuration of TS8000 are:

- Rugged lightweight construction
- Adjustable blade depth settings
- Micrometer style blade adjustment knobs.
- Removable and replaceable die sets
- Die Sets have a contoured cable track
- Adjustable cable strip length
- Locking tool arms
- Locking head
- Free rotating core
- Positive die closure

2.2 Interchangeable Dies

A cable track is precisely machined into each die set. This contoured track was mapped by DMC engineers to support the actual cable sample at the time the die set was designed. The purpose is to create a controlled rotation of the dies/blades as the cable is moved along the track. DMC determines if a standard die set can be used. If there is not a standard die set, DMC will create a custom die set for the particular application. DMC also does extensive tests on die sets with the customer provided cable to ensure functionality.

When the dies are not installed into the tool, the blades are retracted completely into the body of the die. This retraction is a safety feature and keeps the blade protected from damage – each die half has spring pressure on the blade to enable this feature. This spring pressure also keeps the blade pressed up against the depth control knob pin to facilitate a controlled blade position.

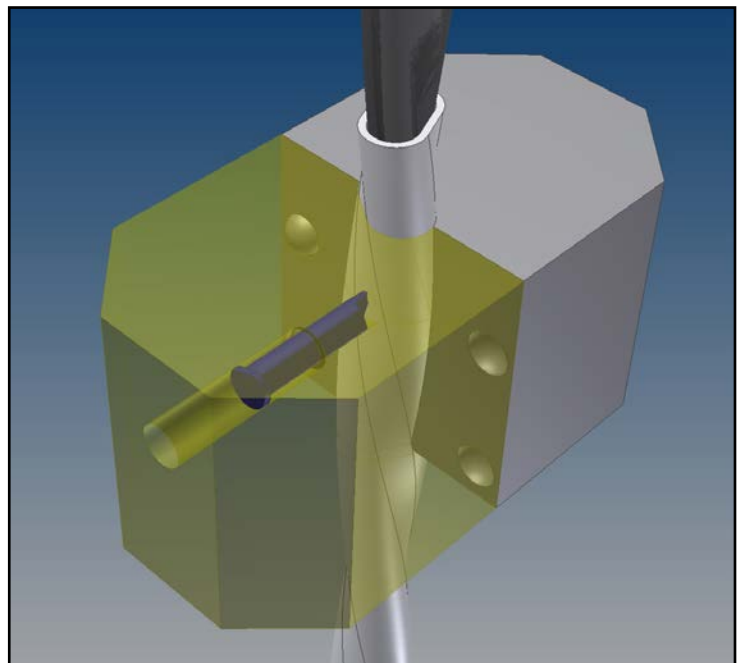
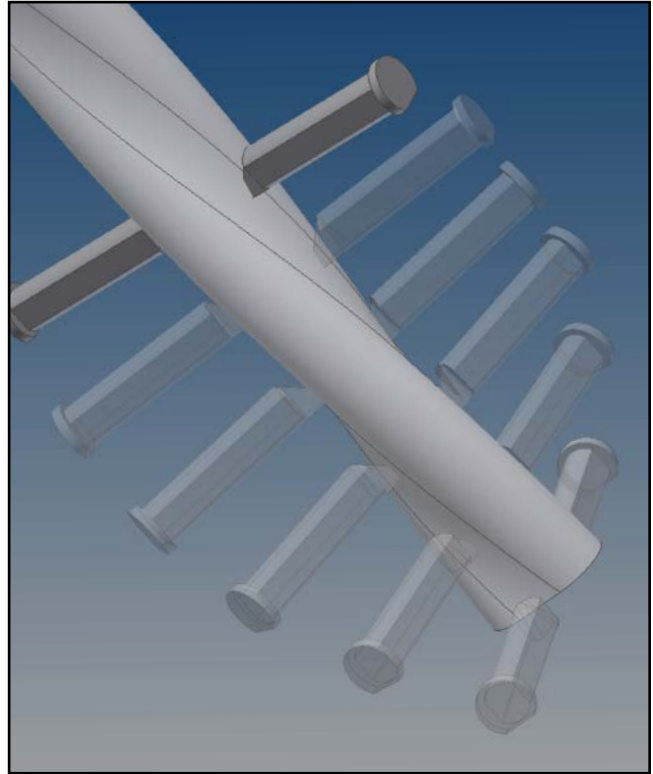



TSK8000 (Kit)



TS8000 (Tool)



Die Container

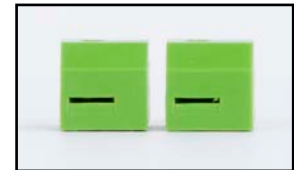

Die Set

3.0 Die and Die Container Identification

3.1 Definitions

TSDXXX - indicates the DMC part number for the die

Die Set - a complete pair of die halves with a DMC part number engraved into the side of the dies

Die Half - 1/2 of a completed die set with DMC part number engraved into the side of the die

Die Markings - physical markings engraved into the side of the die

Die Container - the physical container for storage and shipment of the dies

Die Container Label - sticker on the die container that identifies the cable OD range and starting depth adjustment for the dies

3.2 Die Set Identification

1. Location of die part number

The die part number can be found on the die container label and engraved in the side of the die half. Each die half is marked with an "A" or "B".

2. Location of starting blade depth settings

Die sets come with a starting depth setting for the blades, which can be found on the die container. Each die half is marked with an "A" or "B". The starting blade depth setting for each die half is found on the die container (see above). The starting blade depth for the blade adjustment produces a very light score on the cable jacket. Operator should adjust cutting depth to preferred depth setting.

TSK8000 Twist-Strip Outer Jacket Stripping Tool Die Set Part Numbering System - 1 Inner Conductors				
Tool Frame PN	Die Set PN	# of Inner Conductors	Cable OD Range	Cable Lay
TSK8000	TSD1070	1	.061 to .070"	Left Lay
TSK8000	TSD1080	1	.071 to .080"	Left Lay
TSK8000	TSD1090	1	.081 to .090"	Left Lay
TSK8000	TSD1100	1	.091 to .100"	Left Lay
TSK8000	TSD1110	1	.101 to .110"	Left Lay
TSK8000	TSD1120	1	.111 to .120"	Left Lay
TSK8000	TSD1130	1	.121 to .130"	Left Lay
TSK8000	TSD1140	1	.131 to .140"	Left Lay
TSK8000	TSD1150	1	.141 to .150"	Left Lay
TSK8000	TSD1160	1	.151 to .160"	Left Lay
TSK8000	TSD1170	1	.161 to .170"	Left Lay
TSK8000	TSD1180	1	.171 to .180"	Left Lay

**Cable Measurement Method
One Conductor**

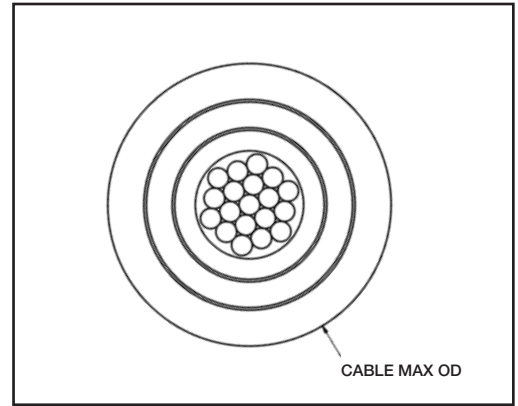

TSK8000 Twist-Strip Outer Jacket Stripping Tool Die Set Part Numbering System - 2 Inner Conductors				
Tool Frame PN	Die Set PN	# of Inner Conductors	Cable OD Range	Cable Lay
TSK8000	TSD2090	2	.081 to .090"	Left Lay
TSK8000	TSD2100	2	.091 to .100"	Left Lay
TSK8000	TSD2110	2	.101 to .110"	Left Lay
TSK8000	TSD2120	2	.111 to .120"	Left Lay
TSK8000	TSD2130	2	.121 to .130"	Left Lay
TSK8000	TSD2140	2	.131 to .140"	Left Lay
TSK8000	TSD2150	2	.141 to .150"	Left Lay
TSK8000	TSD2160	2	.151 to .160"	Left Lay
TSK8000	TSD2170	2	.161 to .170"	Left Lay
TSK8000	TSD2180	2	.171 to .180"	Left Lay

**Cable Measurement Method
Two Conductor**

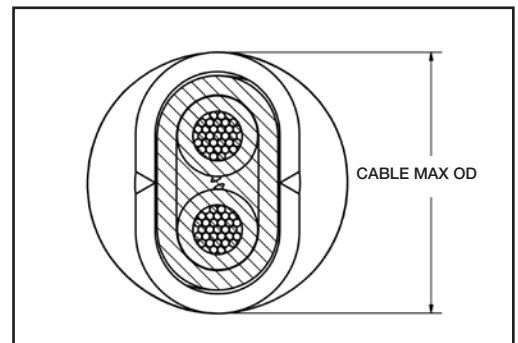

TSK8000 Twist-Strip Outer Jacket Stripping Tool Die Set Part Numbering System - 3 Inner Conductors				
Tool Frame PN	Die Set PN	# of Inner Conductors	Cable OD Range	Cable Lay
TSK8000	TSD3090	3	.081 to .090"	Left Lay
TSK8000	TSD3100	3	.091 to .100"	Left Lay
TSK8000	TSD3110	3	.101 to .110"	Left Lay
TSK8000	TSD3120	3	.111 to .120"	Left Lay
TSK8000	TSD3130	3	.121 to .130"	Left Lay
TSK8000	TSD3140	3	.131 to .140"	Left Lay
TSK8000	TSD3150	3	.141 to .150"	Left Lay
TSK8000	TSD3160	3	.151 to .160"	Left Lay
TSK8000	TSD3170	3	.161 to .170"	Left Lay
TSK8000	TSD3180	3	.171 to .180"	Left Lay

**Cable Measurement Method
Three Conductor**

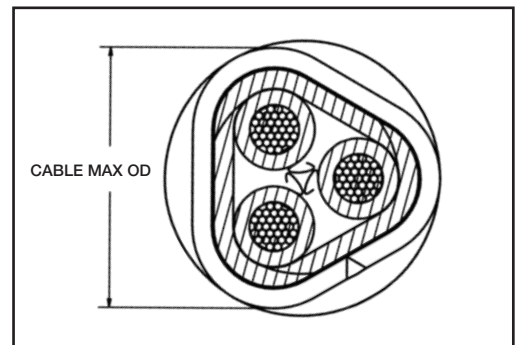

TSK8000 Twist-Strip Outer Jacket Stripping Tool Die Set Part Numbering System - 4 Inner Conductors				
Tool Frame PN	Die Set PN	# of Inner Conductors	Cable OD Range	Cable Lay
TSK8000	TSD4100	4	.091 to .100"	Left Lay
TSK8000	TSD4110	4	.101 to .110"	Left Lay
TSK8000	TSD4120	4	.111 to .120"	Left Lay
TSK8000	TSD4130	4	.121 to .130"	Left Lay
TSK8000	TSD4140	4	.131 to .140"	Left Lay
TSK8000	TSD4150	4	.141 to .150"	Left Lay
TSK8000	TSD4160	4	.151 to .160"	Left Lay
TSK8000	TSD4170	4	.161 to .170"	Left Lay
TSK8000	TSD4180	4	.171 to .180"	Left Lay

**Cable Measurement Method
Four Conductor**

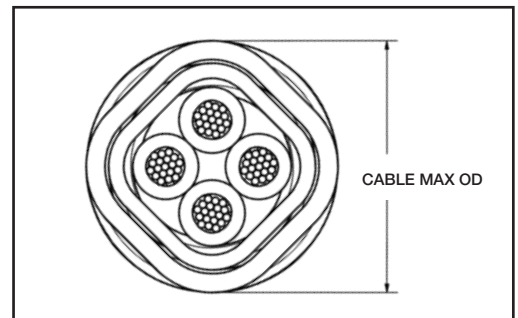

IMPORTANT NOTES

- The “starting depth” for blade adjustment produces a very light score on cable jacket. Operator should adjust cutting depth to preferred depth setting.
- 3 conductor die sets have a non-concentric shape. Therefore, 3 conductor die sets come with only 1 blade. The blade is in the “B” side die. This will produce a single cut longitudinally on the cable.
- Tool allows for .001” incremental adjustments to blade cutting depth.
- Cutting blade depth adjustments are critical for correct performance. Cutting too deep into the cable will damage it beyond repair. Small incremental adjustments reduce potential damage.
- Cable diameter and the # of inner conductors is critical to tool performance. Die sets should be matched to proper cable diameter and # of inner conductors using the chart above.
- In some circumstances a larger die cavity may be needed to accommodate wire that is at the maximum OD for the measured cable part number.
- Universal dies above are designed for cable with a left twist. Dies designed for cable with a right twist have an “R” in the part number: TS**R**XXXX.
- Soft insulation may cause the cable to jam or stick during the stripping operation. Certain applications may not be suited for this tool.
- Certain applications may need a custom die set. If die sets above are not suitable, call DMC at (407) 855-6161 for assistance.

TS8000-CIC: Cable Diameter Gauge Card

The Cable Diameter Gauge Card should be utilized to select a die set.

The max OD and part number of the appropriate die set are shown next to each opening. Find the smallest opening in the gauge card that the cable freely passes through without getting snagged or stuck.

Select the corresponding die set to strip the selected cable.

NOTE: If the cable passes through the opening in the gauge card, but scrapes the sides of the ID of the opening or gets stuck, the user should select the next larger diameter die set.



Lay of Cable

Left Hand Lay
“S” Direction

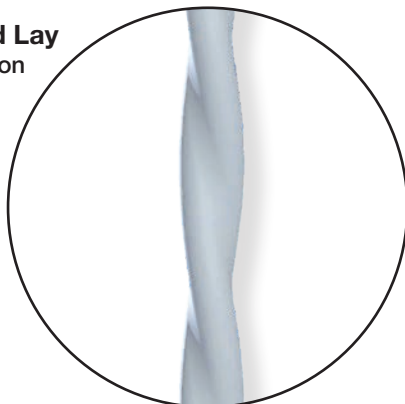

Right Hand Lay
“Z” Direction

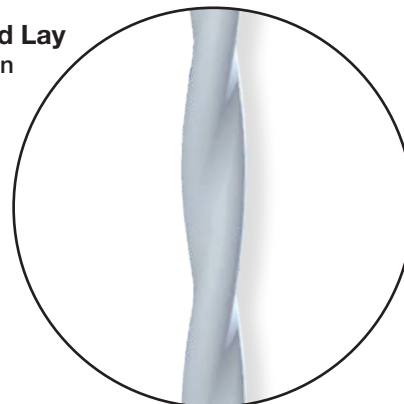

DMC works to provide the most comprehensive solutions for high speed data and shielded, twisted, multi-conductor cable preparation.

TSK8000: Twist Strip Kit* with TSK8000 Only

TSK8001: Twist Strip Kit* with TSK8000 w/All (12) 1 Conductor Die Sets (Cable diameter range from 0.061" to 0.180")

TSK8002: Twist Strip Kit* with TSK8000 w/All (10) 2 Conductor Die Sets (Cable diameter range from 0.081" to 0.180")

TSK8003: Twist Strip Kit* with TSK8000 w/All (10) 3 Conductor Die Sets (Cable diameter range from 0.081" to 0.180")

TSK8004: Twist Strip Kit* with TSK8000 w/All (9) 4 Conductor Die Sets (Cable diameter range from 0.091" to 0.180")

TSK8023: Twist Strip Kit* with TSK8000 w/All (20) 2 & 3 Conductor Die Sets (Cable diameter range from 0.081" to 0.180")

**Includes case, TS8000 CIC Cable Diameter Gauge Card, and accessories; in an organized, foam-lined insert. Individual die set part numbers are listed on page 5.*



4.0 Tool Anatomy

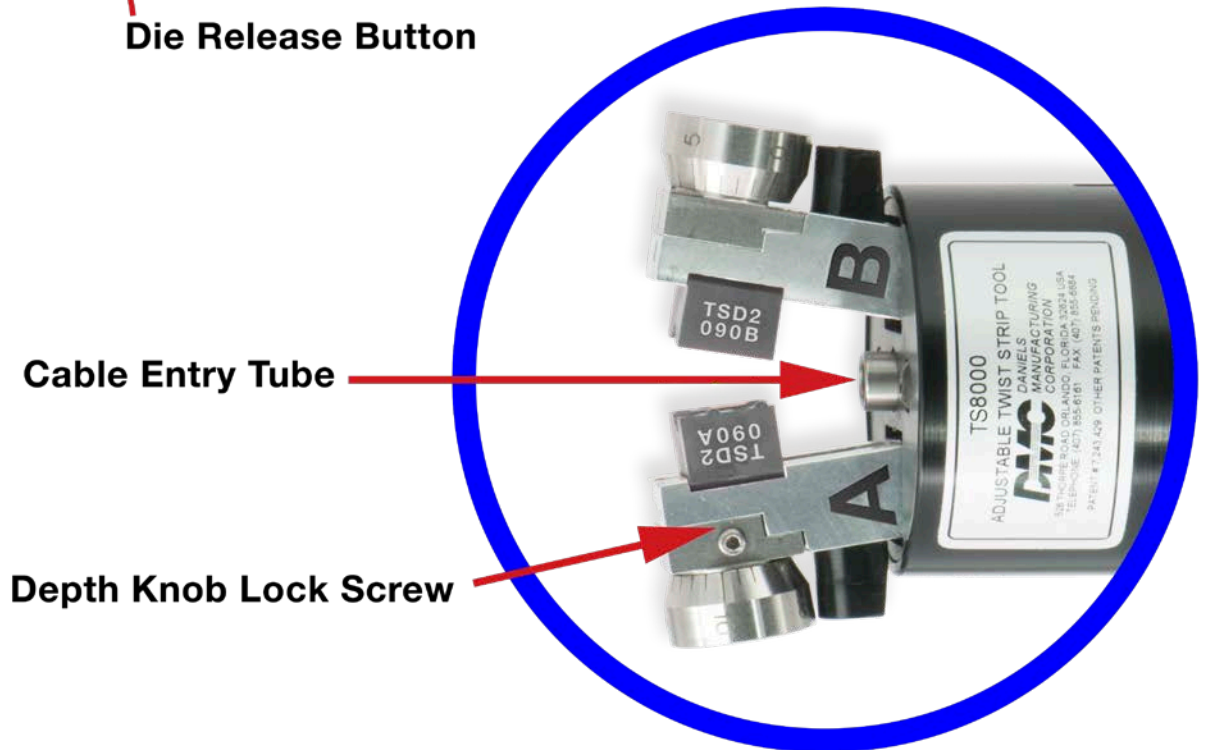
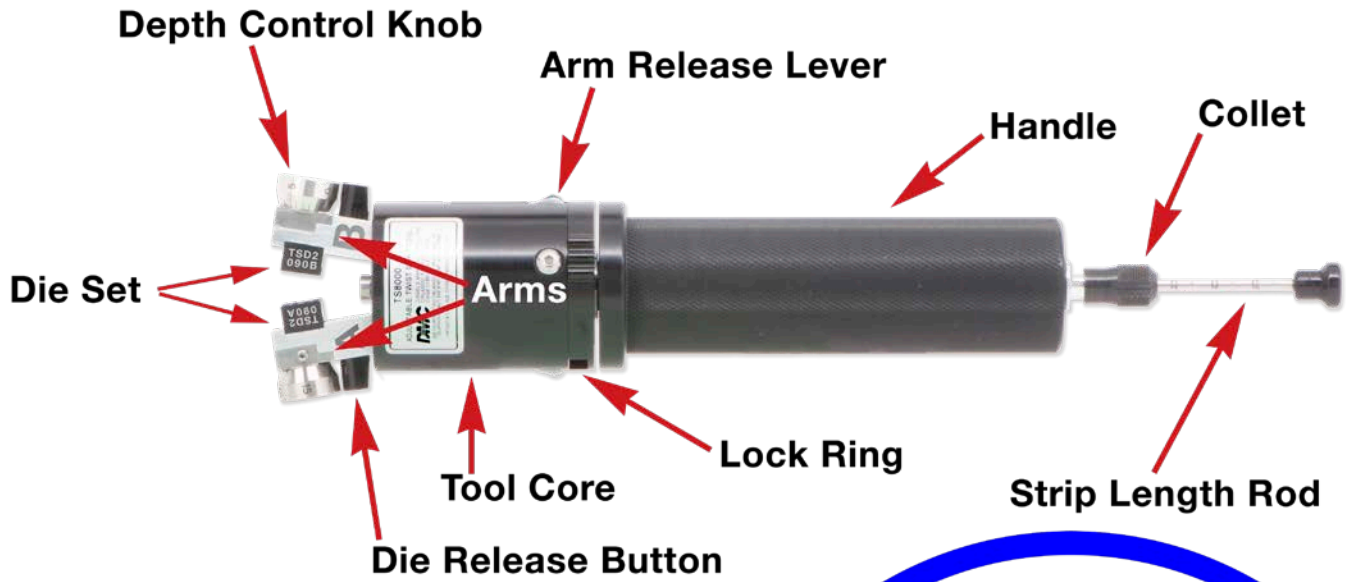

5.0 TS8000 Operation Overview

5.1 Opening Tool Arms

The TS8000 has a unique feature that allows the die arms to remain closed with positive closure force when the tool is in its operational mode. This ensures that the die set will remain closed around the cable when stripping. This is not a spring loaded closure, but a solid mechanism that effectively locks the arms in the closed position. To open and close the tool arms follow these steps:

1. Squeeze the arm release levers (A) flush to the tool core (B) as shown in 4.0.
2. If the arms will not move to the open position with finger pressure, check to ensure the lock ring (D) is not hindering movement. While holding the tool arms in the open position, rotate the lock ring to the right into the lock position (C).
3. Release the pressure on the levers, and verify the arms are securely locked in the open position (D).

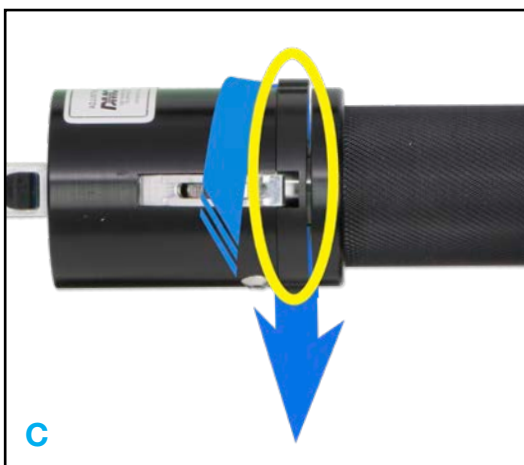

5.2 Installing Dies

Important Note: Die halves and tool arms are marked “A” and “B”. Operator must ensure that the “A” and “B” die halves are placed on the corresponding tool arms.

1. Follow the previous steps to lock the tool arms in the open position.
2. Press the die release button on one tool arm, exposing the die mounting post (A). Place the “A” die half onto the die mounting post of the tool arm marked “A”, repeat for the “B” die half (B). Check to make sure the die half is fully engaged with the die mounting post. Release the die release button, and check to make sure the die half is fully inserted into the tool arm (C). Repeat this procedure for the other tool arm (D).

Note: When changing die sets, always verify that the die part number that appears on both die halves are the same number. Do not mix die part numbers.

3. Follow the instructions below to unlock the tool arms, and bring the die halves together. The die halves must be flush with one another, displaying no signs of misalignment (D). If misalignment or a gap between the die halves is observed, verify the part number is the same on both die halves, inspect to see if any cable remnants or debris is lodged between the die halves. If misalignment is still observed, remove both die halves and reassemble the die set into the tool.

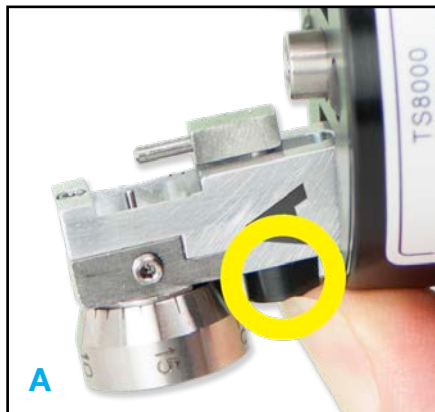

5.3 Release Arms to Operate Tool

1. While holding the Arm Release Levers as shown below (A), rotate the lock ring to the unlocked position (B). Gently release the tool arms and inspect the closure of the die set (C).

Important Note: *It is not recommended to allow the tool to snap shut.*

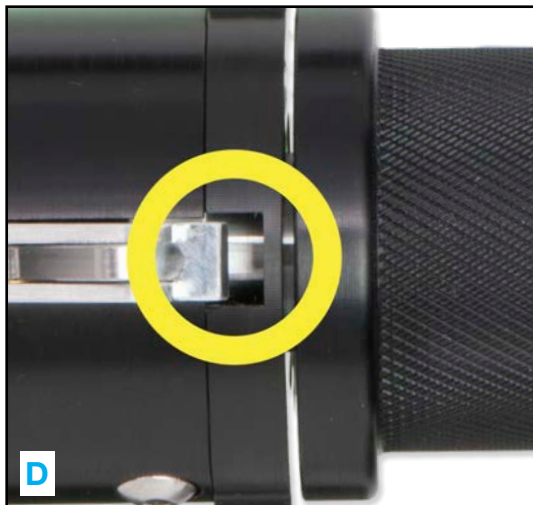
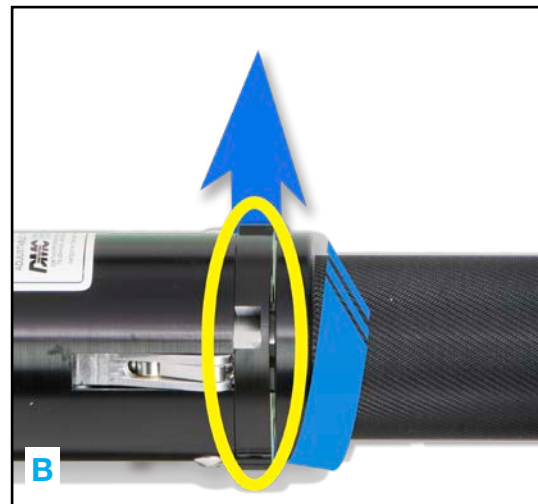

5.4 Setting Cable Strip Length

The TS8000 allows you to adjust the strip length gage for the strip length required. The length rod has both metric and standard graduations.

1. With one hand, grip the tool core and handle which will prevent rotation of the tool core and arms, loosen the collet (A), adjust the strip length rod (B) by sliding the rod into or out of the collet, and re-tighten the collet nut. The strip length rod may be completely removed for long strips or window stripping.

Note: Numbers and graduations on the strip length rod are for quick reference only. When precise strip length measurements are specified, mark the cable, and insert it into alignment with the blades in the dies, and adjust the strip length rod to correspond to that setting.

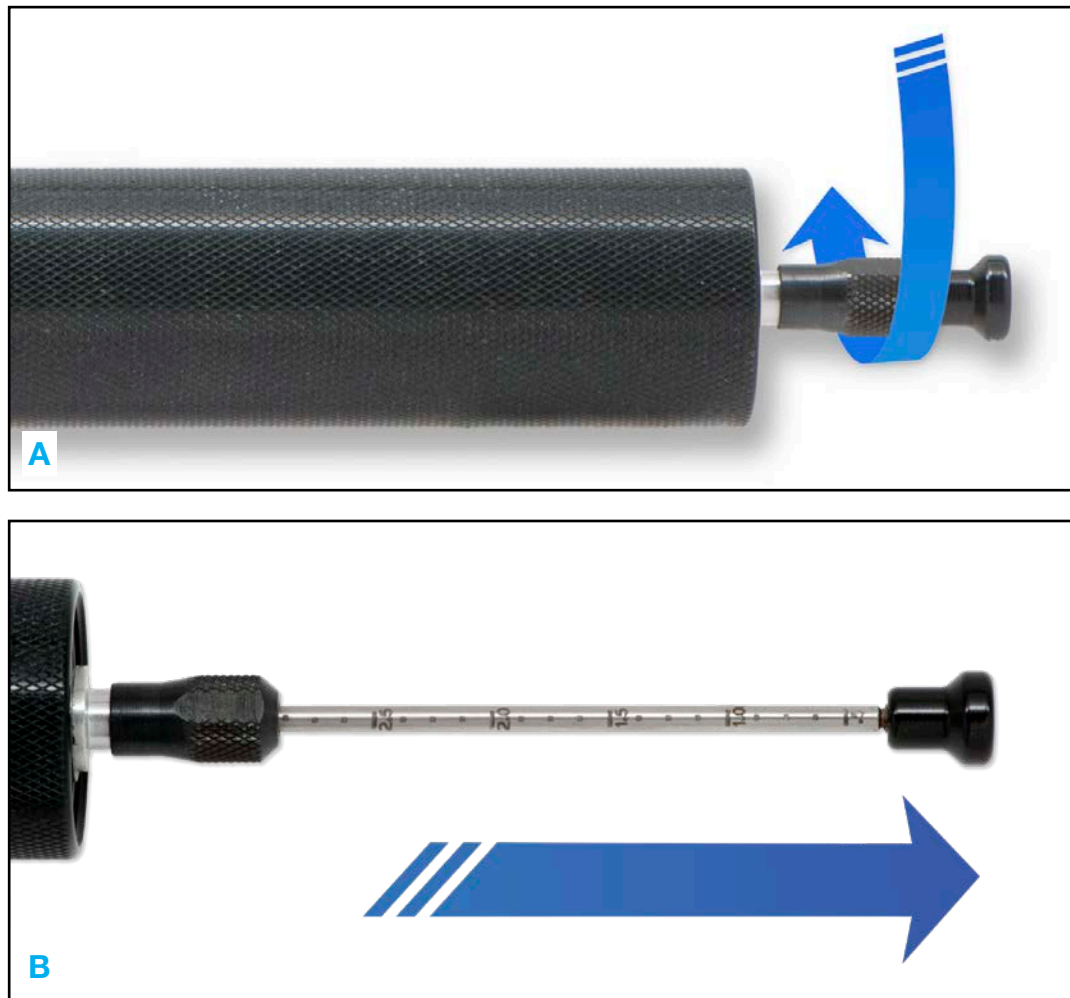

5.5 Inserting the Cable for Stripping

1. Squeeze the arm release levers to open the tool arms/die set (A).
2. Insert the cable into the cable entry tube until it stops on the end of the strip length rod (B), and gently release tool arms until the dies are seated flush together (C).
3. If dies do not fully close, open the arms (by pressing the opposing arm release levers), and rotate the tool core slightly (1/8 - 1/4 turn) and then re-close the dies onto the cable. This should realign cable in the track, and allow the dies fully close.

Note: The tool arms are spring loaded, and a slight gap between will close as the dies rotate around the cable in the next steps of the operation.

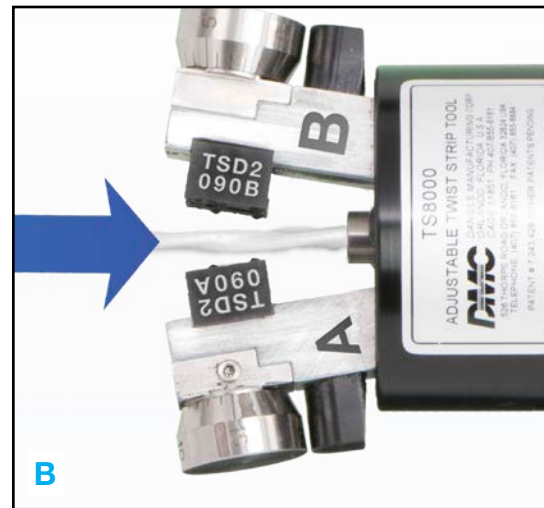

5.6 Stripping the Cable

Important Note: Verify that correct die set is installed for the type of cable being stripped.

1. When the dies are correctly closed around the cable, pull the cable in a smooth and in-line motion away from the tool and the blades in the die set will precisely slit the outer jacket (A). The user may find that scoring instead of cutting completely through the jacket produces the best results. This is acceptable.
2. Some set-up and adjustment will be required to adapt the tool/dies to the exact cable application being prepared for termination.

Important Note: DO NOT pull the cable at an angle, suddenly, or with a jerking motion.

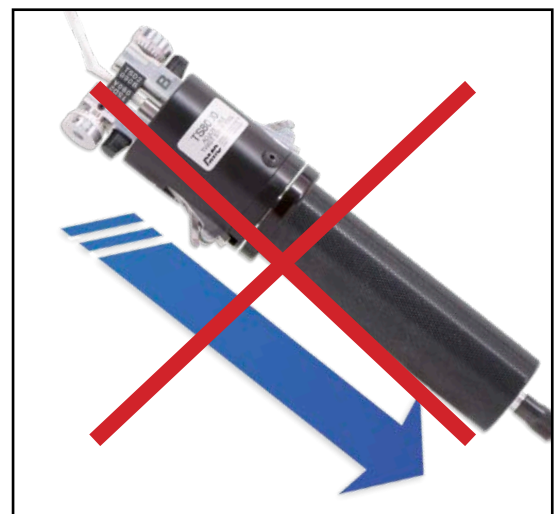
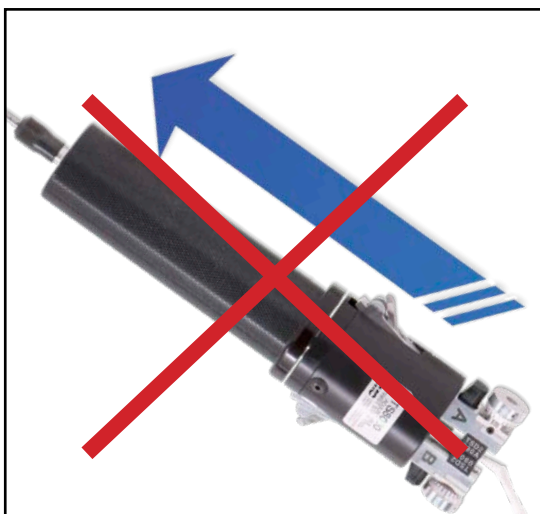

Typical cable after the stripping dies have followed the twist in the cable, and scored a precise slit in the outer cable jacket.

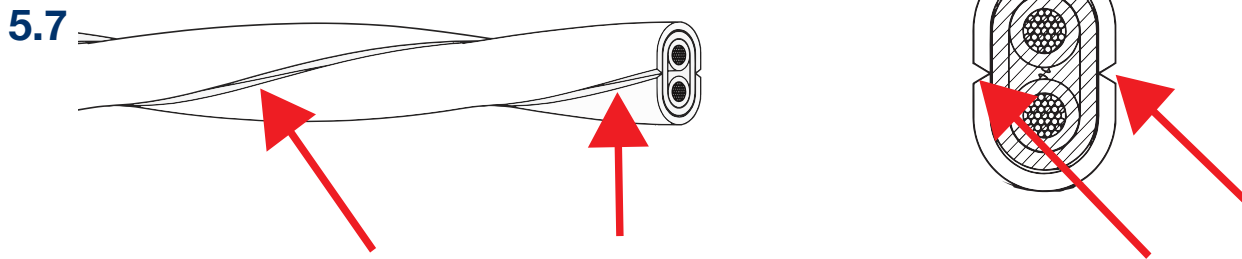
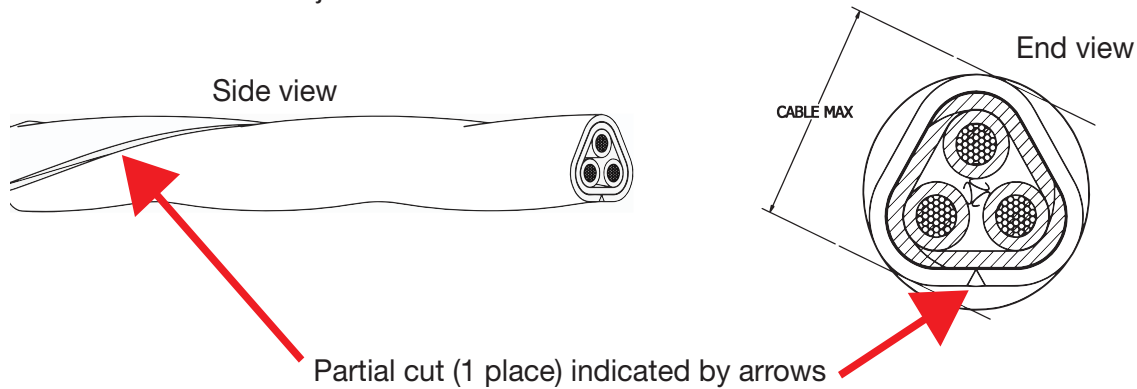

Two opposite slits will occur in the valley of 2 wire cables, whereas, one slit will appear on 3 wire cables. For more information, contact DMC.

Crack and Peel the Jacket

1. Bend cable back and forth 90° to “crack” jacket halves apart (as close to the end as possible). Peel the two halves back and trim with wire snips or side cutters (A). The user may find that the depths for each side are not the same in order to have good quality results. This is acceptable. If no shield damage is present but the wire jacket doesn’t crack apart easily, adjust the depth knob a slight amount for a deeper cut.

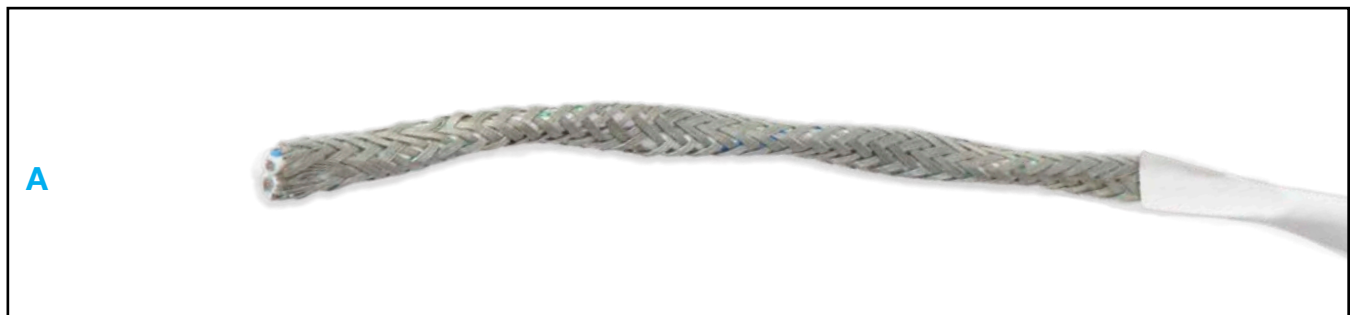

5.8 Damaged or Improper Strip

1. If shield damage is present and undesired (B), adjust the depth knob for a shallower cut. A shallower cut (C) may make the jacket more difficult to crack and peel.

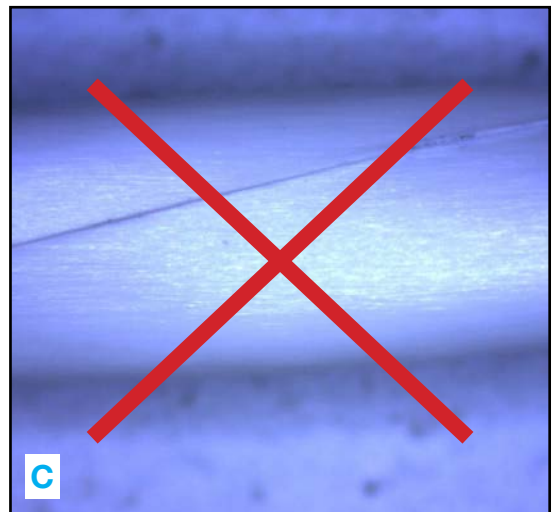
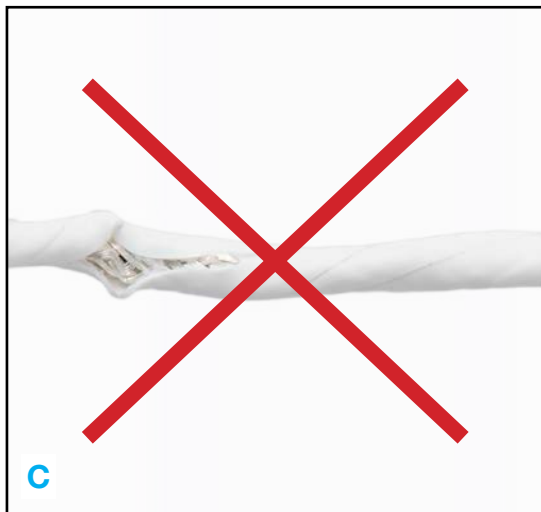
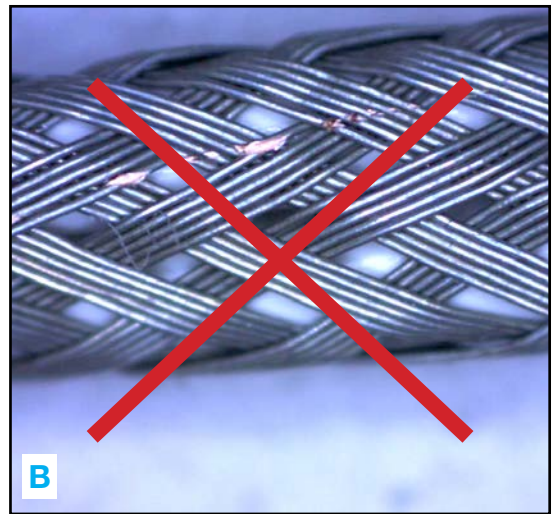
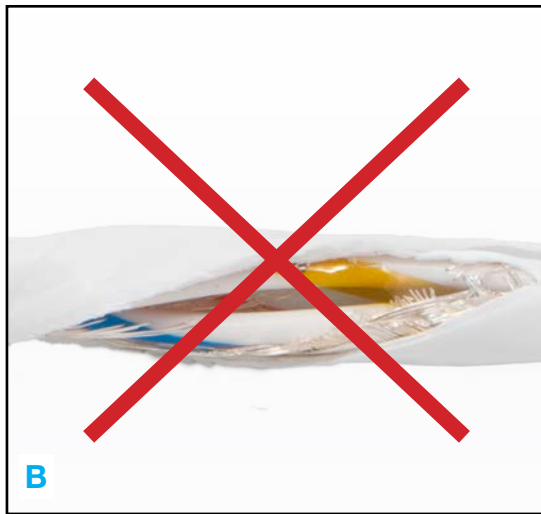

6.0 Depth Control Knobs

6.1 Adjusting the Blade Depth

Important Note: Before adjusting the blade depths, verify that you have the “A” and “B” die halves in their proper location. Refer to section 5.2 if needed.

The TS8000 has adjustable blade depth settings. Follow these steps to set the proper blade depth for a die set:

1. Remove Dies from Tool.
2. Unlock Depth Knob Lock Screws (A).
3. Turn each depth control knob Clock-wise until it bottoms on the Tool Arms (B).

NOTE: Adjusting the depth knob with the lock screw tightened will acc
(Continued on next page)

Adjusting the Blade Depth (continued)

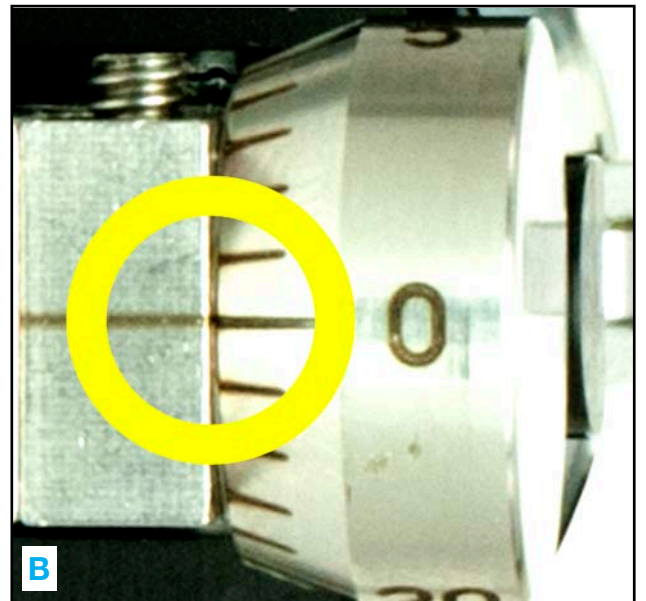
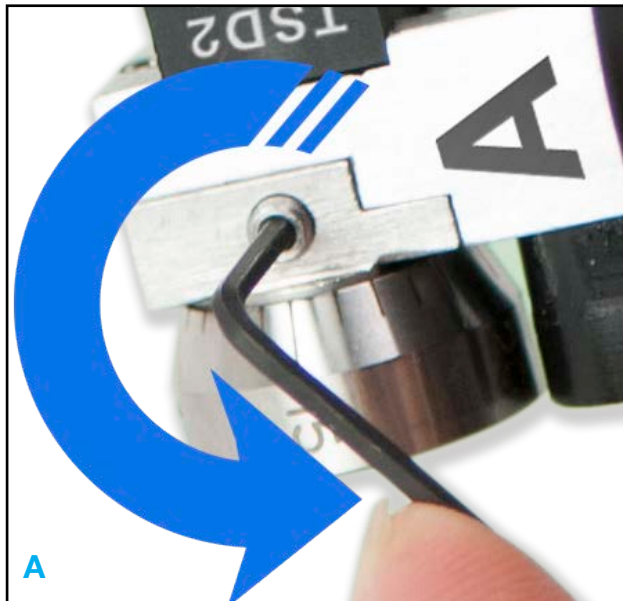

6.1 Adjusting the Blade Depth (continued)

4. Install Dies, making sure to put the die half marked “A” on the tool arm marked “A” and the die half marked “B” on the tool arm marked “B.”
5. Looking at the die container for the installed dies, take note of the recommended depth setting for die half “A” (ex: A=.010”).
6. Turn Depth Control Knob on Tool Arm marked “A” counterclockwise 10 marks (Each hash mark on the knob represents .001” of blade travel) (C).
7. Lock Depth Knob Lock Screw on Tool Arm marked “A” (D).
8. Repeat Steps 5-8 for Die Half marked “B.”
9. Strip sample wire and inspect for desired result, adjust tool as necessary.

NOTE: The starting blade depth setting may be adjusted to accommodate the users desired results and is up to the user to find their preferred setting if different from the recommended setting.

NOTE: The “starting depth” for blade adjustment produces a very light score on cable jacket. Operator should adjust cutting depth to preferred depth setting.

NOTE: 3 conductor die sets have a non-concentric shape. Therefore, 3 conductor die sets come with only 1 blade. The blade is in the “B” side die. This will produce a single cut longitudinally on the cable.

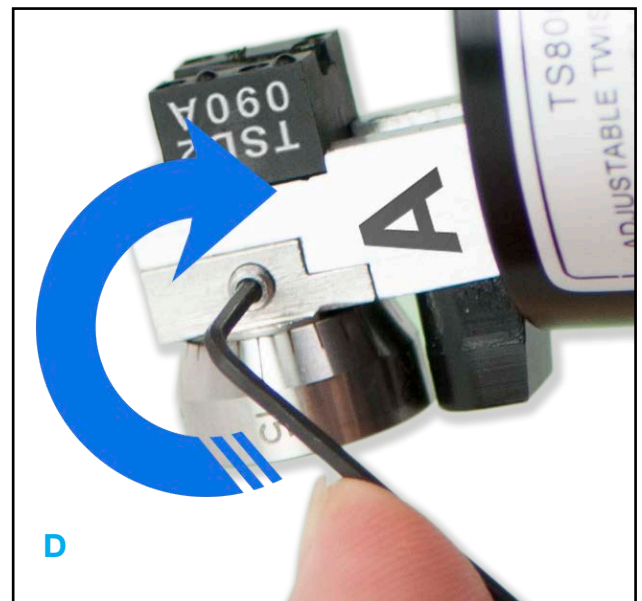
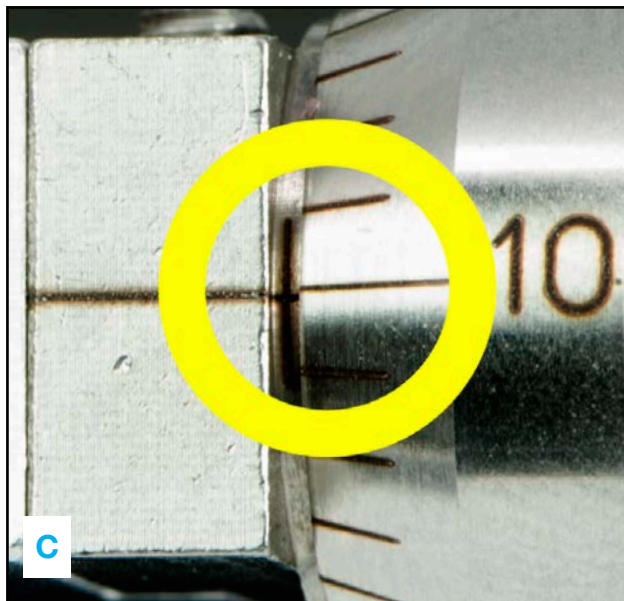

7.0 TS8000 Testing Procedures

7.1 Important Note from Manufacturer: *Prior to the use of this tool, the operator should take a sample of the cable and test the strip. Adjustments in accordance with the previous instructions may need to be implemented for the best possible wire preparation solution.*

7.2 Accuracy of Strip Test

The “accuracy of strip test” allows the user to verify that the stripping of the cable and the depth settings of the die blades meet the user's requirements. The adjustable blades of the TS8000 allow the tool to accommodate variances in cable. To properly test and adjust the blade settings to the desired depth, follow the procedures in the operations overview (5.0).

8.0 Quality Check When Installing Dies

1. Ensure die halves have the same part number.
2. Ensure proper cable part number is being used for specific die set.
3. Set tool to recommended depth settings and test before production.
4. Make sure dies seat flush to one another and are fully retracted into the tool.

9.0 TS8000 Specifications

9.1 Tool Specifications:

- TS8000 accommodates a variety of multi-conductor cable having diameters from 0.0625" to 0.180"
- Strips the outer jacket of shielded twisted multi-conductor, and round cable
- End stripping or window stripping of cable as needed
- Interchangeable stripping dies (with cable track and carbide blade set)
- Adjustable blade depth settings
- Tool Weight: .81 lbs
- Shipping Weight: 2lbs (includes entire tool and accessories in foam lined case)
- Die Arm Lever Force: 4.4 lbs
- Die Arm Lever Length: 1"
- Tool Dimensions: 1.75" wide, 9.75" tall
- Cable Max OD: < 0.180"
- Cable Min OD: >.071"

9.2 Cable Specifications:

- # of conductors: 1-4
- Jacket type: extruded
- M27500 Jacket material: 01, 02, 08, 09, 10,15, 17, 18, 20, 21,14, 23

9.3 Other Cable Specifications:

- # of conductors: 5 or more
- Jacket type: wrapped
- M27500 Jacket material: 03, 04, 06, 07,11, 12, 16, 22, 24

NOTE: *Wrapped jackets create a non-uniform surface for the dies to slide along. This greatly affects the depth at which the blades cut and underlying shield damage may occur.*

10.0

NEMA WC 27500 Shielded & Unshielded Cable Part Numbering System

(Example: M27500-20SB3T23)

M27500	-	20	SB	3	T	23
SPECIFICATION NUMBER	-	CONDUCTOR SIZE	Basic Wire Specification	NUMBER OF CONDUCTORS	Shield Description	Jacket Type

Table 1 - Basic Wire Specifications

Symbol	Basic Wire Specifications	Insulation Type	Temp Rating	Voltage
A	SAE AS50861/1	PVC/NYLON	150°C	600V
B	SAE AS50861/2	PVC/NYLON/BRAIDS	150°C	
SB	SAE AS22759/32	XLETFE	150°C	
SC	SAE AS22759/33	XLETFE	200°C	
SD	SAE AS22759/34	XLETFE	150°C	
SE	SAE AS22759/35	XLETFE	200°C	
SM	SAE AS22759/41	XLETFE	200°C	
SN	SAE AS22759/42	XLETFE	200°C	
SP	SAE AS22759/43	XLETFE	200°C	
SR	SAE AS22759/44	XLETFE	200°C	
SS	SAE AS22759/45	XLETFE	200°C	
ST	SAE AS22759/46	XLETFE	200°C	
TE	SAE AS22759/16	ETFE	150°C	
TG	SAE AS22759/18	ETFE	150°C	
MH	SAE AS81044/9	XL/POLY/KNAR	150°C	
MJ	SAE AS81044/10	XL/POLY/KNAR	150°C	
MK	SAE AS81044/11	XL/POLY/KNAR	150°C	
ML	SAE AS81044/12	XL/POLY/KNAR	150°C	
MM	SAE AS81044/13	XL/POLY/KNAR	150°C	

Table 2 - Shield Descriptions

Single Shield	Double Shield	SHIELD DESCRIPTIONS	Temp Rating
U	-	Not Shielded	-
T	V	Tin plated copper, round	150°C
S	W	Silver plated copper, round	200°C
N	Y	Nickel plated copper, round	260°C
F	Z	Stainless steel, round	400°C
C	R	Nickel clad copper, round	400°C
M	K	Silver plated high strength, copper alloy, round	200°C

11.0

JACKET MATERIAL (TYPE)			
Single Jacket	Double Jacket	Jacket Material	Temp. Rating
00	00	No Jacket	–
01	51	Extruded white PVC	90°C
02	52	Extruded clear nylon	105°C
03	53	White polyimide braid impregnated with clear polyimide finisher over a polyester tape	105°C
04	54	Polyester braid impregnated with high temperature finishers over polyester tape	105°C
05	55	Extruded clear FEP	200°C
06	56	Taped PTFE	260°C
07	57	White taped PTFE	260°C
08	58	Extruded white irradiated PVDF	150°C
09	59	Extruded white FEP	200°C
10	60	Extruded clear PVDF	125°C
11	61	Wrapped FEP	200°C
12	62	Tape of natural polyimide combined with FEP wrapped and heat sealed	150°C
14	64	Extruded white ETFE	150°C
15	65	Extruded clear ETFE	150°C
16	66	Taped PTFE	200°C
17	67	Extruded ECTFE	150°C
18	68	Clear Extruded ECTFE	150°C
20	70	Extruded white PFA	260°C
21	71	Extruded clear PFA	260°C
22	72	Tape of polyimide combined with clear FEP wrapped and heat sealed	200°C
23	73	Extruded white irradiated ETFE	200°C
24	74	PTFE wrapped over a tape layer of natural polyimide combined with FEP and heat sealed	200°C
25	75	Tape layer of white polytetrafluoroethylene (PTFE)	260°C
26	76	Extruded, white (XLETFE)	200°C

12.0 Troubleshooting

12.1 Tool arms will not open

Make sure that the lock ring is not impeding the movement of the die arms. Be sure to press the lever that is inside the die arms, as this lever deactivates the mechanism that locks the arms closed.

12.2 Arms will not stay securely closed with a die set installed

The tool has been worn or damaged and may require repair.

12.3 Arms will not stay securely closed with a die set NOT installed

The tool is designed to hold the position that results when the arms close with a die set installed. With no die set installed, the arms travel past the typical closure point, and the mechanism is not designed to lock the arms at this position. Install a die set and re-examine the closure of the tool.

12.4 One side of the die set is cutting too deeply or too shallow. How do I know which side to adjust?

Each die half is marked with an “A” or a “B” for identification. DMC recommends placing a mark on one side of the cable with a felt tip marker. Examination of the slit will inform which die half is cutting which side of the cable. This will indicate which side of the die set requires additional adjustment.

13.0 Maintenance, Precautions, Service, and Repair

Preventive Maintenance and Precautions

The TS8000 tool and die sets are carefully assembled, inspected, and tested by skilled technicians at DMC. The tool is designed to function indefinitely. The end user is to always store the equipment in the included protective case. Do not expose the tool or die sets to excessive moisture, harsh chemicals, or temperature extremes. Keep the tool and die sets free from foreign debris. No additional lubricant is needed.

This tool and the related die sets are precision instruments and are to be handled as such. Do not drop, do not handle forcefully, and do not use this equipment for any purpose other than intended.

14.0 Service and Repair

Contact Daniels Manufacturing Corporation in order to service or repair the TS8000 and/or dies.

Phone: (407) 855-6161

Email: dmc@dmctools.com

15.0 Custom Dies

For certain applications, a custom die set may be required. DMC requests that a 10ft sample of the User's Cable be sent to DMC, and a project will be opened to evaluate and advise, or to design a new die set for the User's cable application. DMC will determine if a standard die set can be used. If there is not a standard die set, DMC will create a new die set for the particular application. DMC will also test standard and custom die sets with the cable that was supplied by the Twist-Strip User to ensure functionality. Please complete the Cable Sample Worksheet on page 25 and email it to DMC at dmc@dmctools.com. Please call DMC at (407) 855-6161 or email dmc@dmctools.com for more information.

16.0 LIMITATION OF LIABILITY/LIMITED WARRANTY*

LIMITATION OF LIABILITY/LIMITED WARRANTY*

DANIELS MANUFACTURING CORPORATION IS NOT LIABLE FOR CONSEQUENTIAL OR SPECIAL DAMAGES OF ANY NATURE OR KIND RESULTING FROM THE USE OF ANY OF ITS PRODUCTS. OWNERS AND USERS OF DMC PRODUCTS ASSUME FULL RESPONSIBILITY FOR INSTRUCTING THEIR EMPLOYEES IN THE PROPER AND SAFE USE OF SUCH PRODUCTS.

Daniels Manufacturing Corporation warrants each new unit sold by it to be free from defects in material and workmanship under normal use and service. Its obligation under this warranty is limited to the free correction or, at its option, the refund of the purchase price of any such unit which proves defective within 90 days after delivery to the first user, provided that the unit is returned with all transportation charges prepaid, and which shall appear to its satisfaction, upon inspection by it, to have been defective in material or workmanship. This warranty shall not cover any damage to such products, which in the opinion of Daniels Manufacturing Corporation, was caused by normal wear, misuse, improper operation or accident. This warranty is in lieu of all other warranties express or implied. No warranty, express or implied, is made or authorized to be made or assumed with respect to products of Daniels Manufacturing Corporation, other than that herein set forth.

*As defined by PL93-637

These items are included in every TSK8000 Tool Kit:

1. Card Insert: TSK8000-CI
2. Cable Diameter Gauge Card: TS8000-CIC
3. Quick Start Guide: TSK8000-QS

These items are designed to assist the operator in understanding the features, basic operation, proper use, and adjustability of the TS8000 tool. Please contact DMC to order replacements for these items if needed.

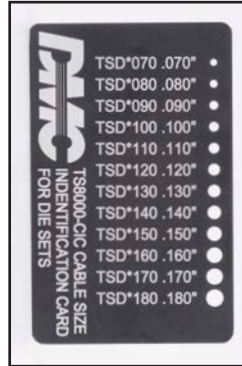

1 TSK8000 Twist-Strip Outer Jacket Stripping Tool Part Numbering System - 2 Inner Conductors				TSK8000 Twist-Strip Outer Jacket Stripping Tool Die Set Part Numbering System - 3 Inner Conductors			
Die Set PN	# of Inner Conductors	Cable OD Range	Starting Depth for Blade Adjustment	Die Set PN	# of Inner Conductors	Cable OD Range	Starting Depth for Blade Adjustment
TSD2090	2	.081 to .090"	A 0.009, B 0.009	TSD3090	3	.081 to .090"	B 0.013
TSD2100	2	.091 to .100"	B 0.013, B 0.013	TSD3100	3	.091 to .100"	B 0.020
TSD2110	2	.101 to .110"	A 0.016, B 0.016	TSD3110	3	.101 to .110"	B 0.024
TSD2120	2	.111 to .120"	A 0.019, B 0.019	TSD3120	3	.111 to .120"	B 0.027
TSD2130	2	.121 to .130"	A 0.022, B 0.022	TSD3130	3	.121 to .130"	B 0.030
TSD2140	2	.131 to .140"	A 0.025, B 0.025	TSD3140	3	.131 to .140"	B 0.034
TSD2150	2	.141 to .150"	A 0.028, B 0.028	TSD3150	3	.141 to .150"	B 0.040
TSD2160	2	.151 to .160"	A 0.031, B 0.031	TSD3160	3	.151 to .160"	B 0.045
TSD2170	2	.161 to .170"	A 0.034, B 0.034	TSD3170	3	.161 to .170"	B 0.048
TSD2180	2	.171 to .180"	A 0.038, B 0.038	TSD3180	3	.171 to .180"	B 0.053

* Cutting blade depth adjustments are critical to correct strip tool performance. Cutting too deep into the cable will damage it beyond repair. Small incremental adjustments reduce potential damage.
 ** Tool allows for .001" incremental adjustments to blade cutting depth.
 *** The "starting depth" for blade adjustment produces a very light score on cable jacket. Operator should adjust cutting depth to preferred depth setting.
 **** Cable diameter and the # of inner conductors is critical to tool performance. Die sets should be matched to proper cable diameter and # of inner conductors.
 © 2017 Daniels Manufacturing Corporation All Rights Reserved www.dmctools.com (407) 855-6161 dmc@dmctools.com Patent #7,243,429

IMPORTANT

Important Note from Manufacturer: Prior to the use of this tool, the operator should take a sample of the wire they will be using and test the viability of the strip. Adjustments may be needed for desired outcome that vary from the factory recommendation.

Important Note from Manufacturer: Different suppliers and/or production runs of cable can vary in key strip dimensions and properties. Inspect frequently and readjust blade depth if necessary.

Important Note from Manufacturer: Care should be taken when handling insulation or shielding as nicked, frayed, or broken strands can cause injury.

DMC DANIELS MANUFACTURING CORPORATION TSK8000-CI REV D **Twist-Strip™**

© 2017 Daniels Manufacturing Corporation All Rights Reserved www.dmctools.com (407) 855-6161 dmc@dmctools.com Patent #7,243,429

3 DANIELS MANUFACTURING CORPORATION

TSK8000-QS-REV C



Important Note from Manufacturer: Prior to the use of this tool, the operator should take a sample of the cable they will be using and test the viability of the strip. Adjustments may be needed for desired outcome that vary from the factory setting.

This Quick Start Guide is designed to assist the operator in understanding the features, basic operation, proper use, and adjustability of the TS8000 tool. For additional information, please refer to the TS8000 manual.

Step 1: Opening Tool Arms

(1-2) Squeeze the arm release levers flush to the tool core. If the arms will not open with finger pressure, check to ensure the lock ring is not hindering movement. (3) While holding the tool arms open, rotate the lock ring to the right in the lock position. (4) Release the levers, and verify the arms are securely locked in the open position.

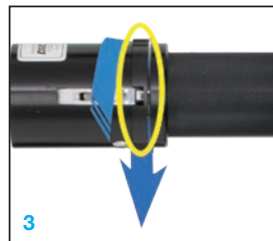

Step 2: Installing Dies

(1) Press the die release button on one tool arm, exposing the die mounting post. (2-3) Place the "A" die half onto the die mounting post of the tool arm marked "A", repeat for the "B" die half. Check to make sure the die half is fully engaged with the die mounting post. Release the die release button, and check to make sure the die half is fully retracted into the tool arm. (4) Repeat this procedure for the other tool arm.

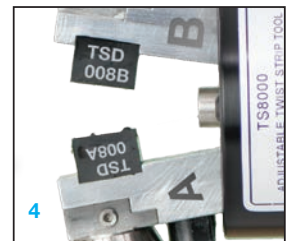



The World Leader in Tool Systems & Technology for the Aerospace, Military and Telecommunications Industries.

Daniels Manufacturing Corporation is the recognized leading manufacturer for the aircraft, aerospace, and high reliability electronics industries, with experience that spans six decades. Our products have been used on virtually every Defense System, Aircraft Program, Land or Sea Going Transport System, Space Exploration Program, and in many other types of manufacturing and support activities.

Our products include, but are not limited to: Manual, Battery Powered, Pneumatic, Electric, and Hydraulic Crimping Tools, Backshell & Accessory Torque Tools, Contact Insertion & Removal Tools, EMI/RFI Shielding Band Tools, Alphasron® Wire Crimp Pull Testers. Fiber Optic Cleave Tools, Safe-T-Cable™ & Safe-T-Cable™ Tools, Wire Strip & Prep Tools, and Aircraft Maintenance Support Tool Kits.

Our website offers detailed tooling information on our product pages and offers over 8,000 standard items available for purchase from our online store. Can't find what you are looking for? Please contact us and we will be sure to get you the tooling you need. Our contact information is below.

Thank you for your continued support of Daniels Manufacturing Corporation.

Business Hours: 8:00 am - 5:00 pm EST

Email: DMC@dmctools.com

Telephone: 407-855-6161

FAX: 407-855-6884

526 Thorpe Road, Orlando, FL 32824-8133 USA

DMC TOOLS ARE MADE IN THE USA

A VETERAN OWNED COMPANY